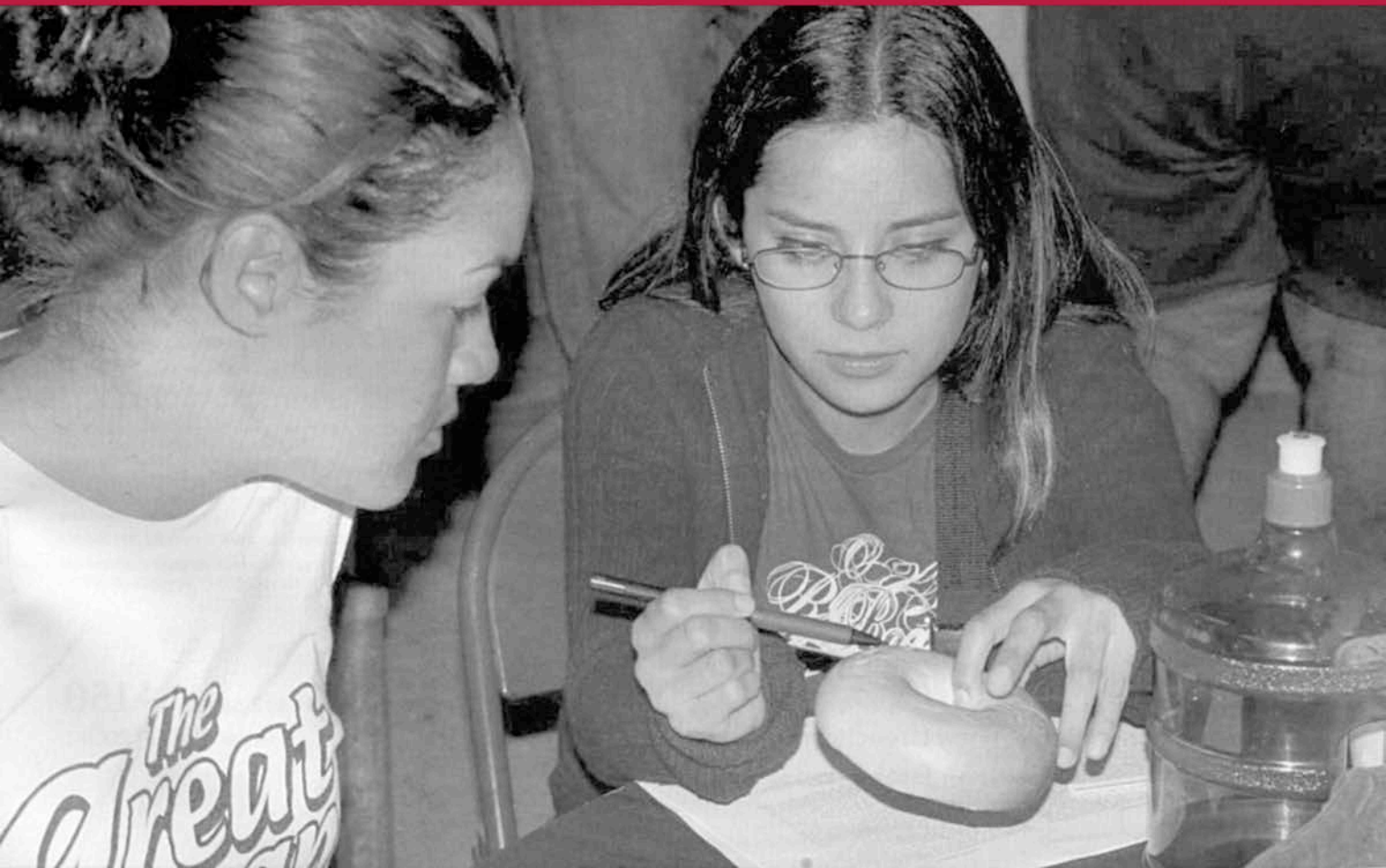


**SPECIAL
CHRISTMAS
EDITION**

EIR

Executive Intelligence Review
December 23, 2005 Vol. 32 No. 49 www.larouche.com \$10.00

**LaRouche Dialogue With Youth:
The Principle of 'Power'**



Towards A New Bretton Woods System

Highlights of
EIR's Berlin Seminar,
June 28-29



On June 28-29, 2005 representatives of 15 nations gathered in Berlin, to discuss, with Lyndon LaRouche, a strategy for revolutionary change in the strategic, economic, financial, and moral-cultural conditions on our planet.

Inspired and provoked by LaRouche's opening remarks, an extraordinary dialogue ensued between the American statesman, and those attending, notably including a number of senior figures having extensive experience in international diplomacy and government. Contributors came from the United States, Germany, Russia, China, India, France, Egypt, Kuwait, Italy, Israel, and South Korea.

Now *EIR* has assembled their contributions, representing a dialogue of what is emerging as the outlines of a potential new global constellation of forces, centered around the prospect of fundamental change in the United States in which the role of Lyndon LaRouche is crucial, into a single volume.

Order from

EIR News Service, Inc.

P.O. Box 17390 Washington, D.C. 20041-0390

Toll-free: 888-EIR-3258

Or order online at <http://www.larouchepub.com>

Visa, MasterCard accepted **Shipping:** \$3.50 first item; \$.50 each additional item.

112 pages **\$150**
Order #EIRSP 2005-1

Founder and Contributing Editor:

Lyndon H. LaRouche, Jr.

Editorial Board: *Lyndon H. LaRouche, Jr.,
Muriel Mirak-Weissbach, Antony Papert, Gerald
Rose, Dennis Small, Edward Spannaus, Nancy
Spannaus, Jeffrey Steinberg, William Wertz*

Editor: *Nancy Spannaus*

Associate Editors: *Ronald Kokinda, Susan Welsh*

Managing Editor: *John Sigerson*

Science Editor: *Marjorie Mazel Hecht*

Technology Editor: *Marsha Freeman*

Book Editor: *Katherine Notley*

Photo Editor: *Stuart Lewis*

Circulation Manager: *Stanley Ezrol*

INTELLIGENCE DIRECTORS:

Counterintelligence: *Jeffrey Steinberg,
Michele Steinberg*

Economics: *Marcia Merry Baker,
Lothar Komp*

History: *Anton Chaitkin*

Ibero-America: *Dennis Small*

Law: *Edward Spannaus*

Russia and Eastern Europe:

Rachel Douglas

United States: *Debra Freeman*

INTERNATIONAL BUREAUS:

Bogotá: *Javier Almaro*

Berlin: *Rainer Apel*

Caracas: *David Ramonet*

Copenhagen: *Poul Rasmussen*

Houston: *Harley Schlanger*

Lima: *Sara Madueño*

Melbourne: *Robert Barwick*

Mexico City: *Rubén Cota Meza*

New Delhi: *Ramtanu Maitra*

Paris: *Christine Bierre*

Rome: *Paolo Raimondi*

United Nations, N.Y.C.: *Leni Rubinstein*

Washington, D.C.: *William Jones*

Wiesbaden: *Göran Haglund*

*EIR (ISSN 0273-6314) is published weekly (50 issues),
by EIR News Service Inc., 912 Pennsylvania Ave., S.E.,
Washington, DC 20003. (202) 543-8002.
(703) 777-9451, or toll-free, 888-EIR-3258.
World Wide Web site: <http://www.larouchepub.com>
e-mail: eirms@larouchepub.com*

European Headquarters: Executive Intelligence Review
Nachrichtenagentur GmbH, Postfach 2308,
D-65013 Wiesbaden, Bahnstrasse 9-A, D-65205,
Wiesbaden, Federal Republic of Germany
Tel: 49-611-73650.

Homepage: <http://www.eirma.com>
E-mail: eirma@eirma.com

Executive Directors: Anno Hellenbroich, Michael Liebig

In Montreal, Canada: 514-855-1699

In Denmark: EIR, Post Box 2613, 2100 Copenhagen ØE,
Tel. 35-43 60 40

In Mexico: EIR, Serapio Rendón No. 70 Int. 28, Col. San
Rafael, Del. Cuauhtémoc, México, DF 06470. Tels: 55-66-
0963, 55-46-2597, 55-46-0931, 55-46-0933 y 55-46-2400.

Copyright © 2005 EIR News Service. All rights reserved.
Reproduction in whole or in part without permission strictly
prohibited.

Canada Post Publication Sales Agreement #40683579

Postmaster: Send all address changes to *EIR*, P.O. Box
17390, Washington, D.C. 20041-0390.

From the Associate Editor

Our special Christmas edition is a unique work of collaboration between Lyndon LaRouche and members of the LaRouche Youth Movement (LYM). Young members have been working intensively for as much as five years, to master the challenges LaRouche has thrown out to them in the study of economics, math, science, and Classical art. Now, this work comes to fruition.

In recruiting young adults in the 18- to 25-year age range to this movement, LaRouche pinpointed the crisis in education today. Sophistry has come to dominate academic life, while the physical economy of the nation is being destroyed, and jobs are being “outsourced” to countries with ever-cheaper wage-scales. Even as economics has become the most popular major on many campuses, the principles governing its study in academia have been totally discredited by events in the real world.

To spark a renaissance in the LYM’s educational work, LaRouche proposed that it be focussed around two extended projects: the study of Carl Gauss’s 1799 Fundamental Theorem of Algebra, and the *bel canto* performance of J.S. Bach’s motet “Jesu, meine Freude.” These two challenging endeavors, he said, would provide the youth with a solid foundation of confidence in their own mental powers. The pedagogical task would be to re-create, through concentrated group efforts, the great discoveries of universal physical principles made by creative minds of the past. These groups, or “Monge Brigades” as they are known, have created an environment in which new recruits can be assimilated and can develop quickly, as each person learns, in order to teach: a “university on wheels.”

Now, in his paper “The Principle of ‘Power,’ ” LaRouche laid out the foundations of the science of physical economy. He then solicited contributions from qualified LYM members on 19 topics, illustrating his concept of *power*. These would be interpolated in his discussion, creating a “field manual” for physical economists.

The result is a marvelous Socratic dialogue, exactly as LaRouche intended. The intensive, cooperative effort to produce these articles in a short period of time, transformed those working on the project, bringing them to a new level of maturity. They had a great time doing it, and invite you, the reader, to join the fun.

Susan Welsh

EIR Contents

Cover This Week

*A LaRouche Youth
Movement (LYM)
pedagogical
workshop in Los
Angeles, California.*



EIRNS/Brendon Barnett

4 The Principle of ‘Power’

By Lyndon H. LaRouche, Jr. “The special circumstances presented to us by the presently onrushing, global breakdown-crisis of this world monetary-financial system, require that we quickly replace what are now clearly the hopelessly failed practices which had been lately taught as “economics” in our universities, governments, and comparable places.” A Socratic dialogue between LaRouche and the LaRouche Youth Movement.

Return to the American System!	6
Economy and the Nation-State	7
The Present Systemic Error in Policy	8
Riemann and Economic Science	10
1. A Crucial Difference in Cubes.	11
The ‘Enlightenment’: Politics and Science	35
A Dividing Line in Culture	36
The Power of Natural Law	38
Science and Identity: A Tale of Two Jews	38
Enter, Paolo Sarpi	40
2. Gauss’s Power	42
The Political Roots of That Attack	48
The Shadow of ‘Power’	53
Einstein’s Point	65
3. Vernadsky’s Contributions	72
See How the U.S.A. Has Decayed!	74
How Those Popular Delusions Work	77
See the Economy As Part of a Noösphere	79
4. The Concept of Leadership.	82
How To Build Leaders	84

A Socratic Dialogue

12 Box 1. Three Species of Number
14 Box 2. Constructing Volumes
20 Box 3. The Torus and the Sphere
22 Box 4. Cardan and Complex Roots
25 Box 5. Fermat’s Principle
28 Box 6. Kästner’s Argument for Anti-Euclidean Geometry
31 Box 7. Gauss, Bolyai, and Anti-Euclidean Geometry
34 Box 8. Hypergeometry
40 Box 9. What Galileo Avoided
43 Box 10. Kepler’s Approach
45 Box 11. Leibniz vs. Descartes
50 Box 12. Zorzi’s Venetian Attack on Renaissance Science
53 Box 13. How Cubic Roots Are Defined Algebraically
54 Box 14. Gauss’s Geometrical Approach to Algebra

58 Box 15. Doubling the Square, the Cube, and Cubic Roots

60 Box 16. Eratosthenes' Sieve

62 Box 17. Euler Misses the Point

64 Box 18. Einstein-Born Dispute

68 Box 19. The Catenary

Strategic News

85 Cheney Is the Albatross Around George Bush's Neck

Some leading Republicans are trying to convince the President that Vice President Cheney has become such a liability, that he has to be dumped. So long as Cheney remains in office, no change in policy can be expected.

87 Breaking Developments

Editorial

88 Revive Civilization

The Principle of 'Power'

by Lyndon H. LaRouche, Jr.

November 25, 2005

The special circumstances presented to us by the presently onrushing, global breakdown-crisis of this world monetary-financial system, require that we quickly replace what are now clearly the hopelessly failed practices which had been lately taught as “economics” in our universities, governments, and comparable places. Instead of those currently failed ideas, we must adopt a notion of economy whose standard is functionally consistent with the crucial difference, *the principle of creative reason*, which is the only quality of action which actually sets man apart from Wolfgang Köhler’s ape.

Contrary to the currently prevalent Anglo-Dutch Liberal varieties of political-economic dogma, or derivatives, such as the Marxist dogma derived largely from London’s Haileybury model, it is that crucial, fundamental difference between man and beast, the uniquely human principle of creative reason, on which all competent attempts at defining a conception of both the nation-state and its economy have depended, since the work of the Pythagoreans, Socrates, and Plato.

The fuller statement of reasons of the necessity for employing this exclusive requirement, will be made clearer in the course of this report.

It is most notable, that the presently ongoing physical collapse of the world’s current monetary-financial system, is the expression of a decline of about four decades in what had been the world’s relatively most successful economy of modern history, a system based upon a revival, under U.S. President Franklin Roosevelt, of what had been the world’s greatest political-economic system, the system which had been known as the *American System of political-economy*.

A Socratic Dialogue

The pedagogical boxes in this article were written by members of the LaRouche Youth Movement (and honorary LYM member Bruce Director). In commissioning the work, LaRouche advised that “the pedagogical presentation represented by that combination of efforts will have the net outcome of presenting the subject-material in the mode of a Socratic dialogue.

“The general rule is: ‘Be ecstatic, provided you do not sail without sextant, compass, and, above all else, a well-aimed rudder.’ Albatrosses will not be supplied for this journey.”



EIRNS/Sharon Stevens

A LaRouche Youth Movement workshop in Detroit, Michigan. The educational program of the LYM is built around re-creating breakthroughs of scientific discovery and Classical art. Here, study of the catenary.

The principal source of the present economic and related calamities of globally extended European civilization, has been the sabotage and willful liquidation, over the recent forty years, of the global fixed-exchange-rate system based on that American System of political-economy which was reestablished under the leadership of President Roosevelt. This was the so-called Bretton Woods system of credit based upon fixed exchange-rates, whose destruction, in favor of a return to the Anglo-Dutch Liberal imperialist system of global monetarist tyranny, was launched under U.S. President Nixon.

That change, under Nixon, was continued with the systemic wrecking of the U.S. domestic economy under National Security Advisor Zbigniew Brzezinski: That has been, broadly, the principal immediate cause for the presently ongoing breakdown-crisis of the current world system. The included result of these measures of self-destruction adopted by the U.S. economy during the 1970s, threw the control of the world's monetary-financial system back into a worse form of the "free trade" mode of the Anglo-Dutch Liberal system which had previously failed civilization so miserably during the 1920s crises of the post-Versailles form of the system leading into the 1931 collapse of the British gold-standard system.

However, although that American System had been the most successful design of both a national economy and a system of cooperation among sovereign national economies, the deep principles which underlie its successes have been poorly understood even among most of its advocates. Even what had

been understood about relevant U.S. history earlier, was ripped out of the academic curriculum beginning soon after the death of President Franklin Roosevelt. During the recent four decades, even the rudiments of design of a barely successful national and world economy, have been obliterated, as if pulled out from the racial memory of the generation currently in charge around the planet today.

In the meantime, the physical-economic conditions of the world-economy, including the growth of population and rise of Asian economies, have been altered to the effect, that even an attempted return to the relatively successful, previously known practices of the American System, while now indispensable, would not be, by itself, sufficient basis for a durable physical recovery of the world's economies under today's conditions.

The once-famed American System of political-economy which had been derived chiefly from the founding of a modern science of physical economy, by the relevant work on this subject by Gottfried Leibniz, must now be redefined in its function, to become the basis for a working physical system of a world economy based upon systemic modes of cooperation, of a dynamic, rather than mechanistic form, among what are, respectively, perfectly sovereign nation-states. The principles associated with Leibniz's influence, must now be taken, in practice, to deeper levels of scientific understanding than had been considered even by its advocates during the recent two-and-a-half centuries.

The change to be made, is feasible today, despite the loss of

entire categories of technologies, skills, resources, and capacities over the recent four decades, especially since the savage, 1977-1981 destruction of our economy under the direction of National Security Advisor Zbigniew Brzezinski. Nonetheless, in principle, an urgently needed reform of our bankrupt present monetary systems, expressed in the methods associated with Harry Hopkins and Harold Ickes under President Franklin Roosevelt, during the 1930s, are applicable models of reference for our republic now. The most important requirement would be a change in the way nations think about economy, a change in thinking which would prompt an upward leap in quality of standards of technology, as the U.S. was compelled, in its economic role as “an arsenal of democracy,” to do in preparation for what was already an inevitable war against Adolf Hitler on that day President Franklin Roosevelt first entered office, looking for a pencil and paper with which to begin actually governing that day.



President Franklin D. Roosevelt (right) with New Deal administrator Harry Hopkins. Their methods to pull the United States out of the Great Depression, are models of reference for our republic now.

Return to the American System!

If we are to succeed in mobilizing political forces for those urgently needed changes upon which survival of what we would not be ashamed to name “civilization” now depends, it is essential that we make clear the fundamental principle of financial organization of and among nations under the American System of political-economy upon which our republic and all its economic successes were premised, *a public credit system*, an American principle of organization, as distinct from the neo-Venetian model represented today by the Anglo-Dutch Liberal *monetarist* system.

In a world monetarist system, such as that of the post-August 1971 interval to date, the power of credit is controlled by the methods which are the intrinsically usurious practice of predatory financier cartels. Under a monetarist system, the power to create, and to regulate the price of credit, even for so-called sovereign national governments, is in the dictatorial hands of a usurious money-interest which operates outside, and often largely independent of the control by governments, as under the form of usury intrinsic to a so-called “free trade” system.

For example, we have now entered an implicitly hyperinflationary-spiralling condition of the present world monetary-financial system, the current IMF system, in which there is no adequate source of credit within the limits set by the monetarist system’s ruling private financier circles, credit sufficient to bring the implicitly bankrupted nations of the Americas, Europe, and so forth, to levels of productive physical activity which correspond to operating above financial break-even levels.

Under such conditions, President Franklin Roosevelt liberated a U.S.A. which had been bankrupted, under President Herbert Hoover. The collapse of the U.S. economy by about

one-half, during the interval following the 1929 crash, was caused, not by the 1929 stock-market crash, but by the way in which Hoover and Andrew Mellon reacted, brutally, and insanely, as Germany’s minister Brüning did in preparing the way for Hitler’s rise to power. In both cases, under Hoover and Brüning, the wrecking of the economy was done through the kind of austerity measures demanded by slime-mold-like concerts of rapacious private financier interests’ usurious reaction to the 1929 stock-market crash, under the kinds of policies carried out under the George W. Bush, Jr. Presidency.

Roosevelt used the power of the state, as expressed by the relevant provisions of the U.S. Federal Constitution, to generate long-term, low-cost credit for building the sinews of what rose to be the greatest economy the world had ever known, an achievement which could never have occurred had Roosevelt not beaten back the predatory, neo-Venetian financier cabals of, chiefly, Wall Street and London.

Today, we, in the U.S.A., as in Europe, face an analogous, but more depraved version of the kind of situation Roosevelt faced on entering office a few weeks after the Bank of England’s favorite of that time, Adolf Hitler, had been awarded dictatorial powers in Germany. Now, as in 1933, only the vast expansion of the flow of long-term state-backed national credit at nominal interest-rates, could expand the production of durable physical values to levels of relevant general employment in basic economic infrastructure, agriculture, and industry at which the nation-state economy is in balance and rising prosperity on current account, and also building physical assets which ensure financial security of the state and banking systems on long-term account.

We must scrap the mode of the International Monetary

Fund introduced under U.S. President Nixon et al., during 1971-1972, when the Nixon Administration and its accomplices turned even the U.S.A. over to the alien sharks of a global, essentially inflationary, monetarist system.

Economy and the Nation-State

To produce that needed technology which the return from a monetarist to a constitutional credit and fair trade system signifies, we must begin now with a return to emphasis upon the relevant principles of science, and with the methods of training the leadership of a new generation in that science. That must begin with *Sphaerics*.

The relatively elementary geometric constructions on which the early Classical Greek developments in *Sphaerics* depended, are the key to founding what we shall show here, presently, to be the only possible, known, contemporary mode in the science of physical economy, the only mode which would be adequate for dealing with the principled quality of the global economic crisis of both the immediate situation, and also for decades yet to come.

The physical characteristics of physical-economic growth of a modern economy at current levels of world population, demand that more than half of the total investment of the economy must be in the form of capital and related improvements which have a physical life-cycle of approximately between one and two generations, between a quarter- and a half-century span. To a relatively large degree, as I shall show the reason for that within the body of this report, these investments must be chiefly economic functions of government, rather than private enterprise. These functions of government are those assorted, as a more or less natural division of labor, at the national, regional, and municipal levels; but the credit for such an urgently needed initiative for both the public and private sectors, respectively, must flow, primarily, not from private financial capital, but from the expression of those natural sovereign powers of the government of the nation-state as a whole, powers expressed in the form of a *public system of national credit*, as under the American System of political-economy.

For this and related reasons, it would be insane, as to be seen in consequence of practice, to continue to act on the mistaken, and ruinous presumption, that real economic growth could be based primarily on management doctrines for the local individual business enterprise. That false presumption would be akin, in effect, to seeking safety within the single, securely locked occupied cabin of a sinking cruise liner. *It is now way past time to recognize, at last, that we live in a world economy in and among nations, a situation in which national populations and their international physical-economic relations, must be conceived as integrated, dynamic, not mechanical processes, processes defined by their continuing function over immediate terms of approximately two generations in the coming life of the planet as a whole.*

However, while it is the improvement of the world's economy which must be our objective, the idea of "globalization" remains intolerable. "Globalization" would be even a criminally insane practice, as this is to be seen in its inevitable effects on humanity at large. For reasons which I shall stress at appropriate locations in the body of this report, no world economy today could be practically tolerable for the present size of the human population, except as a global community of informed cooperation among a leading combination of perfectly sovereign individual nation-state republics. Some dangerously misguided people have been drilled into adopting the view that "globalization is the way to the future"; they are sadly, sadly mistaken, even to the point of functional insanity under today's immediate threats of a global breakdown-crisis of the entirety of the world's present monetary-financial systems. For those who recognize what they are seeing in terms of global physical-economic effects, "globalization" is already a process of plunging into a dark age for all humanity.

The most essential fact of a science of physical economy, a fact whose physical-scientific premises have remained only rarely understood, is that while the generation of the ideas upon which physical progress depends, is spread through cooperation, the origin of the creation of valid ideas is found only within the sovereignty of the fulsome development of the potential scientific and related creative powers of the sovereign individual human mind.

It is also rarely understood, even today, that the necessity of the perfect sovereignty of the nation-state under a financier-ruled planetary system, rests on the inalterable fact of the inherent, unbreachable sovereignty of the creative processes whose existence is specific to the development of the potential of the sovereign individual mind. This is in absolute opposition to all schemes for empire, whether Roman, *ultramontane*, or so-called "globalization." Progress in the human condition has always depended upon processes which do not exist among the apes, mental processes whose expression is manifestly lacking among today's greedy, globalizing, Synarchist and kindred cabals of private financier oligarchy.

The world's currently reigning generation in national economy, has now entered the closing decade or two of its reign in government and economy. The kinds of ideas which have become, heretofore, the habits of that generation in management of the economy, must now be discarded, if nations are to survive even over the relatively short term ahead. The physical capital investments on which current recovery from the threat of a presently onrushing hurricane of world depression depends, would represent a greatly increased, strictly regulated capital debt for up to two generations of approximately a quarter-century, each, to come. The fate of the world's national economies will depend upon both the creation and maintenance of the relatively vast new debt-balances to be incurred for the purpose of physical-economic recovery, on capital account, over the course of those two coming generations of a

world population which already exceeds six billion souls.

So, the choices which must be made, most urgently, today, must be crafted with relevant foresight into those consequences of the present range of choices which our decisions now will determine, for no less than two generations to come. To handle the mass of long-term financial debt which governments must generate as credit, we must foresee and regulate the management of that debt and its timely future repayment in appropriate ways. On that account, we must now take into consideration the kind of immediate and revolutionary changes which now confront the nations and the world as a whole under the present conditions of existential planetary crisis over a span of approximately two generations to come.

In short, the U.S. dollar, for example, will not undergo inflationary depreciation under those reforms. Barring the wasteful burden of great wars, such as that of 1939-1945, the U.S. dollar, as I envisage the U.S.'s long-term economic recovery and growth, will become increasingly harder over the course of the coming two generations, provided that the principles which I address in this report are taken fully into account.

The Present Systemic Error in Policy

The usual source of the incompetent conceptions of economy infecting the ranks of trained professional economists and related others today, is the corrupting influence of the methods of what is precisely defined as *the systemic error of epistemological reductionism*. This includes replacing incompetent governmental policies, which manage economies in the interest of money, with a return to competent policies, policies under which nations regulate the value of money created as long-term credit, credit created for producing the physical benefits which can be promoted in only this way.

To assist this effort to rescue the world's economy from the present peril, it must be made clear that the fault which has been chiefly responsible for the failure of the world economy today, lies with virtually all of those presently favored doctrines of economics taught and practiced by governments and supranational institutions, as practiced within the provinces of today's globally extended European civilization, but also other places. While there are leading economists and others, who represent a selectable body of competence by virtue of experience and intelligence, the needed theoretical-scientific basis for their work has been lacking in some crucial fundamentals of economics as a branch of physical science.

On this account, all of the relevant such commonplace economic and related technological practices, what are classed formally, "genetically," as *reductionist* types of systems, must be replaced. These latter are, chiefly, systems which Europe derived from those pre-civilized types of pagan systems of religious beliefs which are typified as the Babylonian varieties. These were religions, or beliefs tantamount to religious beliefs, which viewed the mass of their societies, their human

subjects, as John Locke did. These dogmas defined people as Physiocrat Dr. François Quesnay presented that same, inhuman conception of the feudal estate's serfs as the cornerstone of his doctrine of *laissez-faire*: the Physiocratic doctrine, from which Adam Smith plagiarized his "invisible hand." Locke, Mandeville, Quesnay, Turgot, and Adam Smith defined most people, implicitly, as virtual cattle.

That kind of generalization associated with Locke and others, is fairly identified, historically, as "Babylonian." That generalization is efficiently identified for discussion by the case of the Olympian Zeus of Aeschylus' *Prometheus Bound*, who prescribed the banning of knowledge of the use of "fire" from the practice of ordinary mankind.

As the celebrated freedom-fighter of U.S. history, Frederick Douglass, emphasized, freedom from slavery begins with the slave's freedom within his or her own mind, a freedom which is expressed only as the conscious development of the scientific and related creative powers of the sovereign individual mind. A slave, or peasant, freed thus within himself or herself, can not be kept in a state of servitude indefinitely. A freed slave who has not become free in his or her mind in this way, will not be able to defend his or her freedom efficiently, when that right is challenged afresh, as we have witnessed this fresh ensnackling of the human mind by the lure of money, even within the U.S.A., itself, and notably among descendants of those whose ancestors had been enslaved, increasingly, during the most recent decades. To reduce men and women to acceptance of some guise of servitude, it is sufficient to degrade their mental life to forms of cultural practices which imitate the brutes, as this was done to much of the post-World War II "Baby Boomer" generation by the satanic cult associated with the axiomatic bestiality of the existentialist and kindred sophist dogmas of the Congress for Cultural Freedom (CCF).

Of the various known systems consistent with the prescription against science by the Olympian Zeus of Aeschylus' drama, the most notable forms, clinically, are the complementary, quasi-Babylonian systems of those opponents of Plato's tradition, which are typified in European history by the work of the model reductionists of the sophist cults in the Delphi Apollo-cult tradition, those of Aristotle and Euclid. The latter are typified by the Aristotelian legacy of the Roman Imperial culture's Claudius Ptolemy, and by the more radical expression of that same legacy, William of Ockham and such among his modern followers, the empiricists, positivists, and existentialists. These are expressions of the method, such as the corruption of the so-called "faith-based initiative," by which a once-freed people is induced to return the mental shackles of the slave to its own wrists and ankles of the mind.

The elementary point of departure for the venture presented in this report, is my emphasis, here, on those constructions by the Pythagoreans and their faithful students, which generate a proof of universal principle, such as the systemic distinction as *powers*, the relatively rudimentary distinctions among



EIRNS/Stuart Lewis

Christian fundamentalists march on Washington. By such means as the so-called faith-based initiative, “a once-freed people is induced to return the mental shackles of the slave to its own wrists and ankles of the mind.”

what are distinguished in mathematics as categorically rational, irrational, and transcendental series. These cases also point directly toward what are, in fact, the scientifically intrinsic incompetence of all contemporary fads of accounting practice in the name of so-called mathematical economics, including those British and related reductionist systems which are merely typified by the empiricist and positivist models of Locke, Mandeville, Quesnay, Adam Smith, Jeremy Bentham, and their Marxist and other derivatives, and carried to the lunatic extremes of “information theory” and “artificial intelligence,” by such fanatical acolytes of the late Bertrand Russell as Norbert Wiener and John von Neumann.

By referring to “reductionist,” or “Babylonian,” systems in mathematics, we have intended to point out those “flat Earth” doctrines of physical science, which are implicitly premised on a system akin to the “Babylonian,” or similar corruptions of previously known discoveries which had been made by those earlier Greeks who had been followers of the Egyptian practice of *Sphaerics*. *Sphaerics* embodied a practice associated with such ancient Greeks as the Pythagoreans, Socrates, Plato, and their school of physical, rather than schoolbook varieties of “ivory tower” geometry commonly taught as “Euclidean geometry” and its derivatives today.

The characterization of systems such as Euclidean geometry and its derivatives, as “flat Earth” dogmas, is literal, rigorous, and precise.

The rectilinear system which is characteristic of the definitions, axioms, and postulates of the Euclidean dogma, and the mechanistic method of Descartes and the leading Eighteenth-Century “Newtonians,” took its origins from the imageries of

the Babylonian priestcraft. What had been, otherwise, valid formulations, which were later incorporated within the quasi-eclectic body of Euclid’s system, were tortured into conformity with the superimposed, axiomatic premises of a Babylonian-like religious cult. That system of definitions, axioms, and postulates presumes, that a universal is limited, bounded, as if by extension of a point into a line, to an extension of an aprioristic, ostensibly original, rectilinear cross-section, which is, thus, primarily flattened. That is to say, in other words, that the standard Euclidean sets of definitions, axioms, and postulates which have supplied the logically “hereditary” basis for usually

taught mathematics today, include “traditional” sets of *aprioristic* assumptions which are implicitly, functionally assumptions that the natural state of the physical universe is the quality of “flatness,” and that curved systems must be explained from the starting point of flatness, as all of the earlier parts of *Euclid’s Elements* do.¹

The frequently encountered effort to trace the roots of European civilization to Mesopotamian, rather than what were, in fact, principally Egyptian proximate origins, is the “red dye” marking of a dangerously infectious, lunatic cult.

Whereas, the scientific system which Greeks such as the Pythagoreans adopted, as *Sphaerics*, from Egyptian astrophysically-oriented science, plots all relevant observations of what might be assumed to be universal phenomena, as observations of a spherical space of uncertain depth, such as the apparent form of the night-time sky: *Sphaerics*.

Johannes Kepler’s uniquely original discovery of universal gravitation, is the classical model of the way in which consummate exhaustion of relevant evidence defines the efficient existence of a universal physical principle beyond the reach of the assumption, as by reductionists Aristotle, Euclid, Claudius Ptolemy, Copernicus, and Brahe, of simply repeated, ruling action in the universe. Thus, the *Sphaerics* upon which Cardinal Nicholas of Cusa and such followers as Kepler, Fermat, and Leibniz premised the emergence of competent modern physical scientific method, marks the distinction

1. If, under his hair, the top of your favorite professor’s head was flat, he was probably a mathematician. Probably, in today’s world, a modern positivist variety.

between the practice of mere copy-cat observation and physical science.

Riemann and Economic Science

The essential cure of those failures caused by the influence of Euclid and related expressions of reductionism, has been summarized by the work of the greatest of the immediate followers of Carl F. Gauss and Bernhard Riemann, beginning as Riemann's revolutionary 1854 habilitation dissertation. The work of Russia's V.I. Vernadsky, in defining the *Biosphere* and *Noösphere*, now provides the point of departure which will be appropriate for successful modes of physical-economic management over the course of the present, young century. To transform that contribution into the required manageable form of political-economic practice, we must return to the roots of all modern European civilization, roots associated with a central role by the circles associated with the Pythagoreans and Plato, to the implications of *Sphaerics*.

As I have just stated here, above, typical of the application of *Sphaerics* to astronomy, was the later discovery of a principle of universal gravitation, as made with unique originality by Johannes Kepler, a discovery which not only refuted the method of Aristotle, of Euclid, and of Claudius Ptolemy, but also that of Copernicus and Tycho Brahe.

The crucial distinction, on which I focus attention centrally in this present report, is that: within the bounds of Babylonian and related reductionist systems, such as those of Aristotle and Euclid, actual creativity, actual discovery of a universal physical principle, is prohibited by the Euclidean or kindred varieties of reductionist schemes. What is thus also prohibited, is any rational form of the recognition of the absolute distinction between man and beast as famously stated by the concluding verses of *Genesis* 1.

For example, in the pre-Euclidean Greek scientific thought of such as the Pythagoreans, Socrates, and Plato, all mathematical-physical orderings are defined by the method of *Sphaerics*, as illustrated by their treatment of such elementary topics as the spherical qualitative distinctions among rational, irrational, and transcendental magnitudes. These topics include, the generation of the doubling of the square, the Theaetetus-Plato system of regular solids, and, implicitly, the extension of this study to the more populous class of Archimedean system of quasi-regular solids. These latter are of relevance for modern physical chemistry, as the significance of this mission of discovery of fundamental principle was addressed in the relevant work of the late Professor Robert Moon. Moon's work on this account, as I have referred to this in other locations, points to some of the implications of my defense of the importance of these studies in light of the implications of the work of V.I. Vernadsky.

The works of the relevant ancient Greek thinkers associated with the scientific methods of the Pythagoreans, have often been described by relevant scholars as "murky waters." To a

qualified scientific thinker, this should not be so. The relevant habituated problem today is, that people who do not wish to replicate the quality of creative mental activity which those ancient Greeks employed, have relied on methods borrowed from the Romantics' modes of practice of literary interpretation, rather than the method of actually repeating the original experiment. Since most



arttoday.com

Johannes Kepler (1571-1630). His discovery of the principle of universal gravitation was a unique application of "*Sphaerics*" to astronomy.

of such literary commentators of recent centuries have been trained in reductionist methods of scholarship, they are obliged by their ignorance of the historical and related implications of the scientific method of *Sphaerics*, either to claim ignorance of the meaning of relevant, surviving ancient evidence, or to engage in the Sophist's sport of "what he really meant to say, was."

The reason such people often find the intellectual waters of *Sphaerics* murky, or "unknowable," is that they simply do not wish to swim. So, the Clerk Maxwell who falsified the earlier history of what we call electronics, stated in defense of that acknowledged fraud, in a moment of candor, that he simply refused to acknowledge the existence of "any geometry other than our own," signifying British empiricist prejudices of that time. Since *Sphaerics* is not only a method of physical science, but a method which can be re-experienced by reliving the relevant known experiments, there is nothing as intrinsically murky about the surviving evidence as most scholarly and other commentators have, often wishfully, presumed.

The source of the typical blunders of such scholars, is that they share the intrinsic incompetence of all reductionist models. They refuse to take into account the essential, principled nature of the functional distinction between ape and man, and, thus, so to speak, share beliefs which would tend to induce the behavior of a virtual monkey in their believer. Therefore, they sell shoes to fit the wrong species. That distinction which such commentators have failed to make, is of the type of species-distinction expressed by the method of the Pythagoreans and by such followers and collaborators of the Pythagoreans as Socrates and Plato.



Gottfried Leibniz (1646-1716). The founder of the science of physical economy used the German word for “power” in the same sense that LaRouche does here.



Abraham Kästner (1719-1800). He proved that the rectilinear axiomatics of the Euclidean system were absurd.



Bernhard Riemann (1826-1866). He broke science free from mind-deadening slavery to Euclidean and non-Euclidean geometries alike.

If you work to replicate the experimental discoveries in the way the known method of Sphaerics requires, you will get the same, or very similar results consistent with the results they report. Then, you will understand them clearly, even if you have virtually no knowledge of the existence of the Greek they spoke. There is absolutely nothing murky about the method of *Sphaerics*; all competent practice of discoveries of principle in science since that time has been based on replicating their reported experiments, and their method.

The functional meaning of “physical” in geometry, was defined for ancient Greek scientific thought, by the Pythagoreans’ use of that notion of *dynamis* as associated with modern European use of the term *dynamics*, a use introduced by Leibniz to correct the incompetence of the work of Descartes. It was emphasis on that fact, introduced by Leibniz, which was crucial in his exposing the incompetence of Descartes, Newton, and their followers during his lifetime, and by those who followed Leibniz’s method in later centuries. The Classical term *dynamis*, is a term associated with Leibniz’s use of the German term *Kraft*, as in his founding of the science of physical economy, and as the same meaning is rightly assigned to related uses of the English term *power*. As I have emphasized in my “Vernadsky and Dirichlet’s Principle,” Vernadsky emphasizes that the organization of the functions of the Biosphere are dynamic, and Riemannian in this sense, as opposed to the mind-deadening damage done to the mind of believers by a Cartesian system.

For example, where scientists in the tradition of Plato and Leibniz deploy the concept of “power,” a cause of an axiomatic-like change of state within a process, the modern reduction-

ists use the term “energy,” which is merely the name for an “effect,” not a physical principle.

So, let us proceed. We must begin, for the sake of the young-adult generation which must be prepared to lead the future, with certain crucial steps of an elementary nature, as I do now, in the following chapter of this report.

1. A Crucial Difference in Cubes

In our customary modern secondary school instruction in algebra and geometry as adolescents, we were confronted with two ways of defining the differences in physical meaning among three elementary topics of mathematics: the distinction among what are termed, respectively, *rational*, *irrational*, and *transcendental* series of numbers. The less frequent, but correct choice of way of defining these distinctions, is to proceed from the standpoint of constructive physical geometry represented by the ancient Pythagoreans, to uncover the *physical* meaning of these categorical distinctions. In this, preferable case, we are using a geometry in which there is no systemic agreement with the axiometrically rectilinear standpoint of reductionists such as Euclid and his followers.

For the thoughtful student, studying this conflict, the implication of that difference should be immediately clear. Contrast that method of instruction, which is associated with the standpoint of the more popular, more conventional practice by secondary schools and university algebraic methods, in which the definitions are awkward, and the definition of the third category, transcendentals, was not considered solved until the

work of Hermite and Lindemann at a point relatively late during the Nineteenth Century; even those latter, formalistic claims, were of an epistemologically doubtful character, especially when reexamined in a relevant broader context of higher physical geometries, such as those of Riemann. (See **Box 1**.)

Right answers are desirable, like healthy babies, but making a baby, as the Pythagoreans made their discoveries, and adopting one, as cookbook varieties of textbook methods of the reductionists usually do, are not the same thing. The act of

creating a previously unknown discovery of a universal principle, or recreating the experience of the discovery by another, is the only way in which the acquisition of scientific or Classical artistic knowledge of a principle can be made one's own "child."

The pivotal example which I shall emphasize in this first chapter of the report, is the most general implication for the practice of science as a whole, of Archytas' construction of the doubling of the cube by the methods of *Sphaerics*. Now, think

Box 1

Three Species of Number

Let's play a game! One player will geometrically construct two lengths by whatever means he chooses. Can the other player always determine how the lengths were created? In fact, can he ever? Maybe this is not a game worth playing!

A first hypothesis would be that the constructor took a certain length, and simply made two lines by replicating his length a whole number of times: for example, using — as our basic unit, we could create lengths by adding this line to itself, perhaps creating

— — — — —
and
— — — — —

with the unit. These two lines have what the Pythagoreans called a rational relationship between themselves, expressed as the ratio 4-to-5, 4:5, or the familiar fraction 4/5. But how can we find the unit if the lines are not marked off already? An algorithm that will find the common line that made the two (if one exists!), operates by measuring the larger with the smaller and then using the remainder to attempt to measure the smaller original length:

For example, if we were the second player and were given the lengths:

—————
and
—————

We could measure the larger by the smaller:

—————|—————
Which leaves a small remainder left over:
— — — — —

Which can be used to measure the smaller original line:

— — — — —|— — — — —

Now the line on the right has a remainder as well:

— — — — —

Now, measure again, this time measuring the left remainder with the right:

— — — — —|—

We now have a remainder on the left that can measure the remainder on the right:

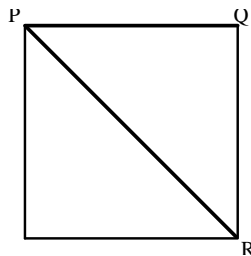
—|—|—

Aha! Now all lines are accounted for and expressible, since they can be built up starting from this smallest unit magnitude. Try it with a friend!

Now, will it always happen that this technique succeeds? What if two magnitudes had no common, literal measure, and we could never find the common unit?

Take the case of the side of a square (PQ) and its diagonal (PR) (**Figure 1**). As Plato's *Meno* dialogue indicates, the diagonal is the solution for the creation of the doubled square, as the solution to a problem regarding *area*, not length. Here, the

FIGURE 1

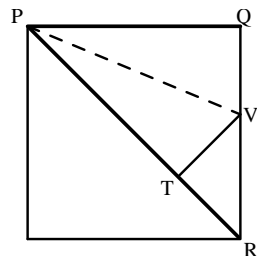


diagonal was not created by the simple addition of lines. The same technique of exhaustion applied above takes a new geometrical form with this example, which you should work through with a square cut out of paper.

Fold down the top line PQ onto the diagonal PR (**Figure 2**). Q will reach T and you will have a fold on your paper of PV . Looking at PTR , this is similar to the method with the lines above. We have cut line PT (of length PQ) out of hypotenuse PR , leaving behind remainder TR . But now something remarkable has happened. Since TV (and TR) are the same as QV in the construction, and the sides of a square are equal, $QR - QV$ is the same as $PQ - TR$, where TR is the remainder $PR - PQ$. This is analogous to measuring 7 with 4 above. But, look! The small remainder triangle VTR has exactly the same relationships as the original triangle PQR , so this process will never end! What does this imply? How small is our final, smallest unit, if it indeed exists?

Let's try again! What if we had found a common unit, what kind of ratio would the two lengths have? Well, if each length is made of a number of the unit, then it either could or could not be evenly divided in half producing whole units (it is either odd or even). Now if PR were odd, then the square that it makes would be made of an odd number of little unit

FIGURE 2

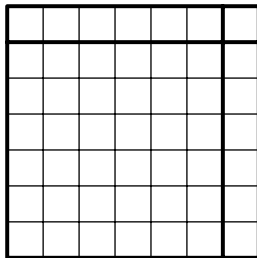


of the water which a given cube could contain, as compared with the relevant sphere or torus of the same capacity. Now, use a cylinder and cone, each able either to contain that amount of water, or to double that amount in the cylinder to observe the geometry of effect of transferring the same quantity into a conical vessel. *In attacking this challenge, it is important to convey to oneself, as to others, a sense of the physical content of the operation, rather than merely the procedure employed in making that descriptive comparison.* What

must be avoided in the mathematical-physics practice of a science of economy in particular, is the fallacy of substituting the non-physical, merely formally arithmetic algebra of a physics subject-matter for the relevant action performed by a *physical principle* which is never, and can never be *contained within* a mathematical formula.

The function of competent uses of mathematics in physical science, and shaping policies of nations, is to define the shape of the walls of that virtual aquarium within which the non-

FIGURE 3



A square that is odd on each of its sides can be thought of as an even square with an L-shaped gnomon added to it. That gnomon is two even lines, with one square left over. That leftover square means that the entire odd-side square has an odd number of unit areas.

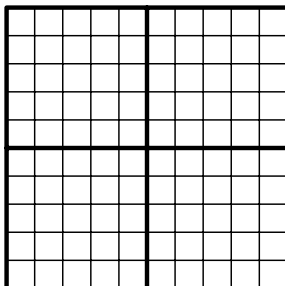
squares, but PR was supposed to make a square twice as big as PQ , and an odd number certainly isn't twice as big as anything, for odd means that it cannot be evenly divided in two (Figure 3)!

So, PR must be even in order to be twice the PQ square. Now if PQ were also even, it would mean that we got carried away in making our small unit, for a ratio of two even numbers is also a ratio with an odd number. For example, 2-to-3 could be 4-to-6 if you really wanted to call it that, just like one half is the same as two quarters. The only conclusion left is that PR is even, while PQ is odd, which makes the PQ square also have an odd number of small unit area squares. But wait, PR is even, which makes the PR square divisible this way (Figure 4):

Half the area of PR is even, but the PQ square, which is supposed to be half the PR square, is odd! We have failed again, and that was the last possibility. What does this mean? Is there really no possibility of a common unit? Then how can we express the relationship between these lengths?

This is an *irrational* relationship: The

FIGURE 4



side PQ and the diagonal PR of a square cannot both be expressed as a ratio countable by a common unit. But the inability to express a magnitude does not mean either that it is unknowable or unconstructable.

Theaetetus recounts, in Plato's *Theaetetus* dialogue, his concept of an entire class of such magnitudes: those that correspond to the sides of squares of commensurable areas, and to the sides of cubes of commensurable volumes. It should come to no surprise that the power to double a square or a cube, being of a higher *power* than that of doubling the line, is inexpressible in terms of lines.

The Transcendental Species

Beyond these two species, the rational and the irrational, exists the *transcendental*. Nicholas of Cusa's discussion of the quadrature of the circle (the exact meas-

urement of the circumference of a circle in terms of its diameter) demonstrates this impossibility (Figure 5).

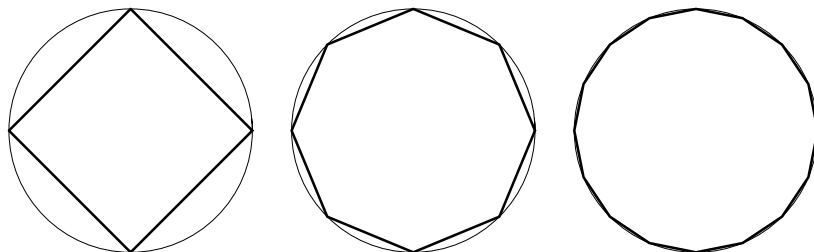
The attempt to approximate a circle by polygons of ever-increasing sides fails. Even at an astronomical number of sides on the polygon, each tiny side remains straight while the circle is curved in that interval. The failure of this approach demonstrates *negatively* that the circle is of a higher, *transcendental* species-type than the lines of the polygons with which we are attempting to reach it. It can be grasped only with a higher power, which Cusa named the isoperimetric ("Minimum-Maximum") principle.

The Kepler problem, arising as a distinction between irrationals and transcendentals, was a commission to future thinkers to develop a physical mathematics based on *power* as primary, rather than the non-physical hoax, which is only capable of expressing the effects of a power by the imagery of the tracks it leaves in its wake.

Riemann's surface functions, as elaborated in such locations as his *Theory of Abelian Functions*, more fully reveals the geometric implication of the existence of circular functions, which are infinitely powerful from the standpoint of the algebraic irrationals, and of forms of transcendentals of powers greater yet than the circular.

—Jason Ross

FIGURE 5



mathematical fish of reality swim. Competent mathematics, which is based on constructive geometry, not arithmetic, would never defend the blunder of seeking to define those fish explicitly, but only the mathematical container which the activity of those fish expresses. It is the crucial physical experiment itself, or the equivalent in Classical artistic composition, which addresses the physical reality itself. This point is demonstrated most forcefully in any competent approach to the study of social processes in general, especially with respect

to the economies they represent. Nothing points out that set of relations more simply and clearly than the discovery which occupies this present chapter, Archytas' solution for the geometrical construction of the doubling of the cube.

Such was the genius expressed by the Pythagoreans and Plato, by Eratosthenes, Nicholas of Cusa, Kepler, Fermat, Leibniz, Kästner, Gauss, and Riemann, among others of kindred disposition.

This method of constructive geometry, which Europe has

Box 2 Constructing Volumes

Construct!



Members of the Seattle LYM work on the problem of constructing various volumes.



is construction. Construction tests the viability of those ideas the mind thinks best conceived: Are they really of legitimate parentage, or did an adulterer slip in when your guard was down, and adulterate the whole affair?

You may think: "Ah, I know this! This is simple. . . ." But when you try to pull your idea from your mind into the visible world . . . well, it was not nearly so simple as you thought! The mind rushes, unencumbered by the material world, capable of conceiving of perfectly consistent systems, glorious designs, elaborate . . . machinations . . . which have little relation to reality. The body, meanwhile, weighed by its own flesh, mucks in the mud, capable of pursuing little but the sensual pleasure of a pig. Where is their connection?

Construction is the mean between mind and body; it is the means of making music through a harmony of these two diametrically opposed elements. It is the only means of investigating reality. If you take up the challenge laid out here by Lyndon LaRouche, if you get your hands dirty in pursuit of its solution, you were likely to produce an idea directly related to the idea which determines what I am now writing, as I attempt to convey the fruits of our struggle with LaRouche's challenge. You were likely to laugh, as we did—and as I suspect LaRouche did—when he wrote out the problem as he did. In just a few words, he presents an inquiry which takes many hours, and really, many people, to adequately investigate. And if that were not enough, there is an element of the seemingly impossible which we were immediately aware was embedded there.

First, LaRouche asks us to think of

The difference between a real economy:

and the fantasy of a financial analyst:



Here LYM members contemplate the magnificent construction of the Grand Coulee Dam.



Here, we see human activity wasted on the "virtual economy," known as the stock exchange.

derived from the Pythagoreans' practice of the method known as *Sphaerics*, is crucial in the modern discovery of a universal physical principle, as this is illustrated by Johannes Kepler's uniquely original discovery of universal gravitation. The notion of the way in which a discovered universal physical principle has a specific type of object-like effect, can not be made fully clear until the student has mastered Bernhard Riemann's insight into what he identifies as "Dirichlet's Principle," in its application within the domain of Riemannian

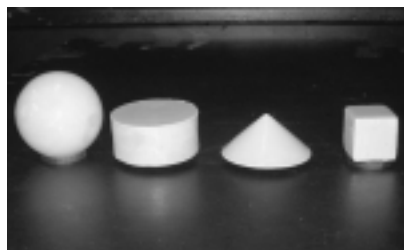
hypergeometries. Pending the experience of discovering that principle, it is useful to cultivate the joyfully impassioned desire to reach the point of intellectual self-development, at which one could experience that discovery in one's own mind.

Now, those words of caution stated, construct a solution which correlates these discoveries of principles in the form they appear in the various containers. *For each case, adduce the single principle of action, a physical principle, which underlies the constructed demonstration.* (See **Box 2.**)

the volume of water a cube could contain "as compared with the relevant sphere or torus of the same capacity." If he means what he says, he asks us for a "cubature of the sphere": He asks us to produce a cubical volume equal to the volume of the sphere. This is certainly no less a problem than the quadrature of the circle, and actually, a good deal more of a problem.

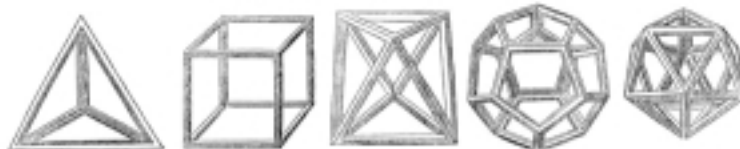
The quadrature of the circle is the process of making ever-closer approximations of the length of the perimeter of the circle by drawing circumscribing and inscribing polygons of an ever-increasing number of sides, as Archimedes did. The process is intended to result in the creation of a square whose area is exactly equal in length to the area of the circle. Archimedes applied to the circle a method associated with Eudoxos, a friend of Plato, called "exhaustion." The method of exhaustion had worked well to produce precise results for other problems, like the quadrature of the parabola, and it was likely used with similar effect on some of the volumetric problems we encounter below.

FIGURE 2



The side of the cube is equal to the radius and height of both the cone and cylinder, and to the radius of the sphere. (We apologize for the glaring absence of the torus.)

FIGURE 1



These Platonic Solids, drawn by Leonardo da Vinci, are the only regular solids possible to construct within a sphere. They point to one crucial difference between surfaces and volumes. (Try bisecting the sides of the octahedron, to make a solid with 16 faces, the way you would bisect the sides of the octagon to make a polygon with 16 sides, to fully understand what I mean.) Also note that because of its "regularity," its equal-sidedness, the cube is "spherical." (We will see more on this in a moment.)

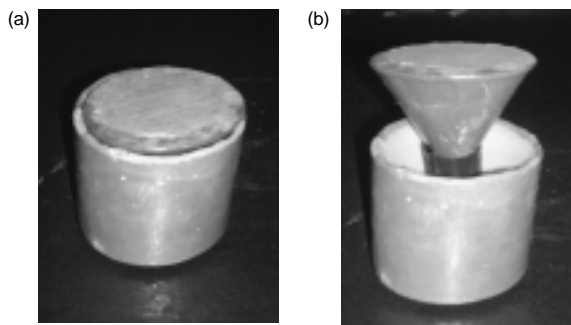
But Nicholas of Cusa showed that a true quadrature of the circle is ultimately impossible because of the "species difference" between the curved line of the circle and the straight lines of the polygons, as discussed in Box 1. The cubature of the sphere is certainly related to this problem, but while the number of polygons that can be inscribed in a circle is infinite, there is a limited number of solids that can be inscribed in the sphere (**Figure 1**).

LaRouche then calls for a cylinder and cone "each able either to contain that amount of water, or to double that amount in the cylinder." This requires determining the relations among cube,

sphere, torus, cylinder, and cone (**Figure 2**). Perhaps you, like some of us, were trained in school and can spout out the formulae for the volume of the sphere, cylinder, and cone as a Pavlovian response. Perhaps, you were not able to contain yourself, even as the problem was first posed. If this is so, you must find an incredulous person, or better yet, muster incredulity yourself, and consider this paradox: We are told that the volume of the cone is less than one half the volume of the cylinder (**Figure 3**). (The fun is figuring out how much less.)

But, as the incredulous person will
Box 2 continues on next page

FIGURE 3



A cylinder (a) and the cone that fits into it (b). The cone has the same base and height as the cylinder.

Discuss this with a class of between fifteen and twenty-five adult youth of between eighteen and twenty-five years of age. Give them the listed “ingredients” specified above. Have

them, rather than a teacher, generate the proposed construction and its implications. (See **Box 3.**)

As the great representative of the school of the Athens

FIGURE 4

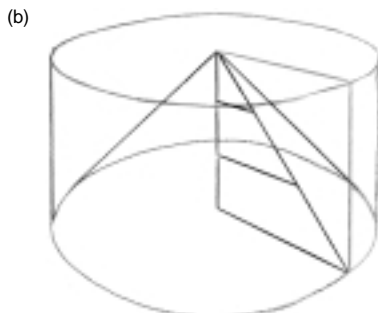
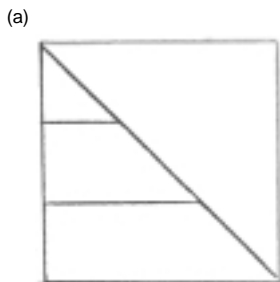
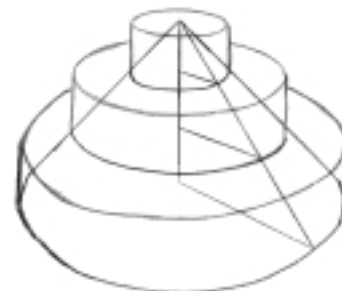


FIGURE 5



If you rotate the rectangle (a) around its left edge, you will produce the cylinder (b). If you rotate the right triangle formed by cutting the rectangle in (a) along its diagonal around the same edge, you will produce a cone that has the same base and height as the cylinder, as seen in (b).

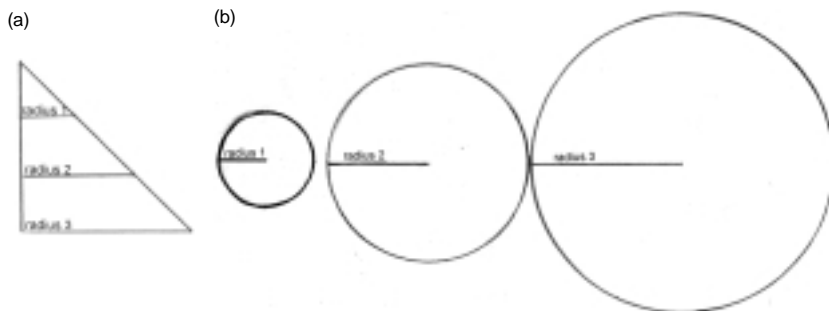
The height of each cylindrical layer is $1/3$ the original height of the cone. The base of each cylindrical layer has a radius equal to the base of triangle produced by that cut. The first, smallest base has a radius $1/3$ the radius of the cone; the next base has a radius $2/3$ the radius of the cone; and the final base has a radius equal to that of the cone.

point out, the cylinder can be produced as a volume of rotation, the effect of rotating a rectangle about an axis that coincides with its edge. If you cut that rectangle in half along its diagonal, you will have a right triangle which is half the area of the original rectangle (**Figure 4**).

would change as the square of that radius (**Figure 6**). The cone’s volume changes in a non-arithmetic way, mak-

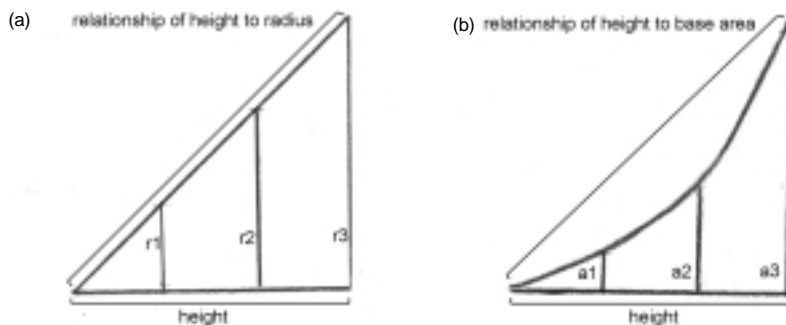
Given this fact, “reason” leads to the conclusion that the volume of the cone will be exactly half that of the cylinder. Of course the reason used here, is none other than the “lazy reason” that Socrates spurns in the *Phaedo*, or the sloppiness Eratosthenes ridicules in the playwright who has a character proclaim that the tomb of a king is too small, and therefore the tomb should be doubled, by doubling the length of each side. Clearly, Eratosthenes tells us, this is a terrible blunder, for the volume would now be eight times greater, which the playwright could have known, if he only took the time to think about it.

FIGURE 6



The three radii in (a) correspond to the three areas shown in (b).

FIGURE 7

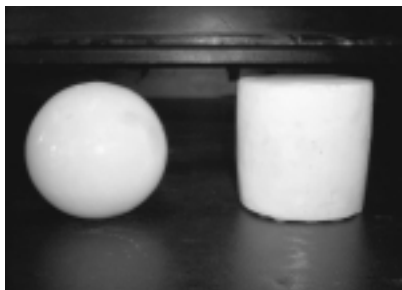


A graphical representation of the essential difference between the volume of a cone and cylinder. The vertical lines in (a) represent the various radii. The vertical lines in (b) are equal to the corresponding squares of those radii.

Platonic Academy, Eratosthenes, emphasized, the importance of Archytas' solution for this, the so-called Delian paradox, was crucial in the development of both mathematics

and physics from the time of Pythagoreans such as Plato's friend and collaborator Archytas, into modern times. This also represents the method resurrected for the founding of

FIGURE 8



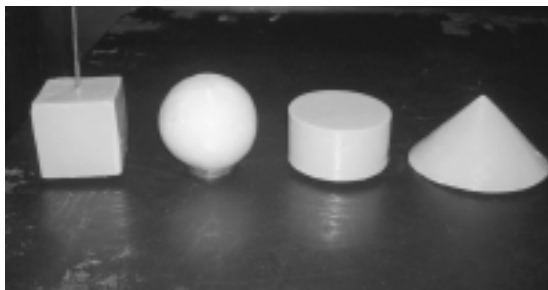
Here we have a cylinder, the base of which has a radius equal to the radius of the sphere, and the height of which is equal to the diameter of the sphere.

ing the relationship between the volume of rotation of the triangle and rectangle, between the cone and cylinder, different than the relationship between the areas of the triangle and rectangle (Figure 7). This is another difference between the surfaces and solids, with which we must grapple.

The relationship between the cylinder and sphere can be adduced in a similar way. First build a cylinder with a radius equal to that of the sphere, and a height equal to that of the sphere's diameter (Figure 8). Then weigh them (note that this works only if they were made of the same material), and compare their weights. Ask, why is this true? Why did we get this result? This provides additional insight into the problem.

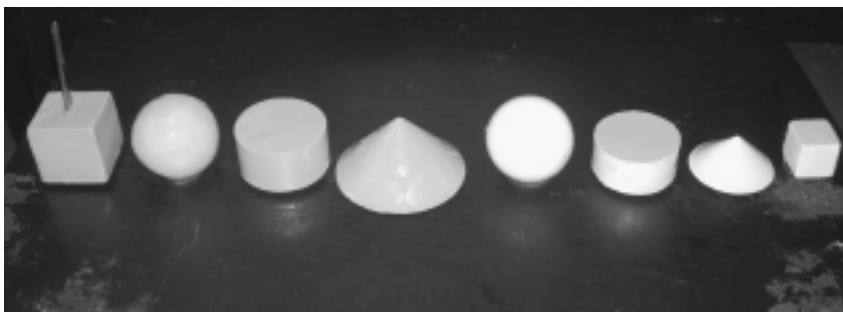
But then you are reminded, as if remembering something nearly forgotten, we must now construct a sphere, torus, cone, cylinder, and cube with the

FIGURE 9



These solids all have the same volume, as determined from the volume of the sphere. (Again, forgive the absence of the torus.) Ask yourself, how did we determine these volumes? Each posed a particular problem of finding a cube root. Finding the volume of the cube was nearly impossible!

FIGURE 10



The four solids on the left are of equal volume. The original solids are on the right. In the original set of solids, the cylinder and cone both have a radius and height equal to the radius of the sphere, and the side of the cube is equal to the radius of the sphere. Notice the dramatic difference in the size of the two cubes and the two cones. The two spheres are the same size.

same volume! Although related to the preceding exploration, this adds a new element to worry us (Figures 9 and 10).

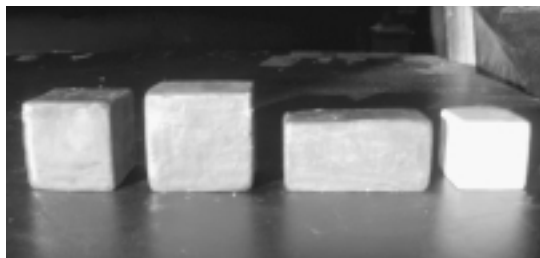
Now we come to the question of doubling these volumes, and the geometric effect in this doubling. There are three ways in which the volume of a rectangular solid can be doubled (Figure 11). This is also true of the

cylinder and cone (Figure 12). In the images shown in Figure 13, only one of the three doubled volumes is similar to the first.

In like manner, the sphere can only be doubled in one way, because a sphere must always be similar to any other sphere. (Ponder the implications of this for a moment.) The cube must be similar

Box 2 continues on next page

FIGURE 11



Our original cube, whose side is equal to the radius of our sphere, is at the far right. Next to it is a rectangular solid whose width is double that of the cube, while its height and depth are the same as the cube. The third solid to the left has a face that is double the face of the original cube, but its depth is the same as the cube. Both of these solids are double the volume of the original cube, and their construction did not require that we find a cube root. But the fourth solid on the left is the doubled cube. Its construction required a profound addition to our array of capabilities.

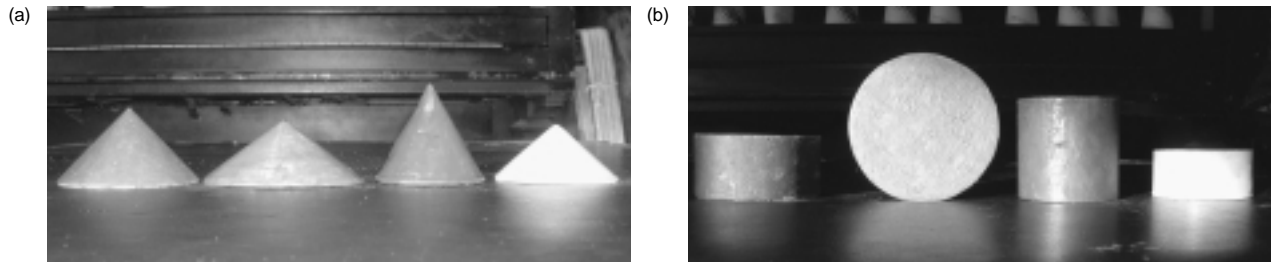
modern experimental physical science by the Fifteenth Century's Cardinal Nicholas of Cusa's *De Docta Ignorantia*. This present chapter of our report is devoted to making clear those historical implications of the debate over cubic functions.

For related reasons, the implications of the doubling of the cube by the method of Archytas, became the most crucial of the formal political issues fought out within modern European mathematics and related physics matters, from the Sixteenth

Century to the present day.

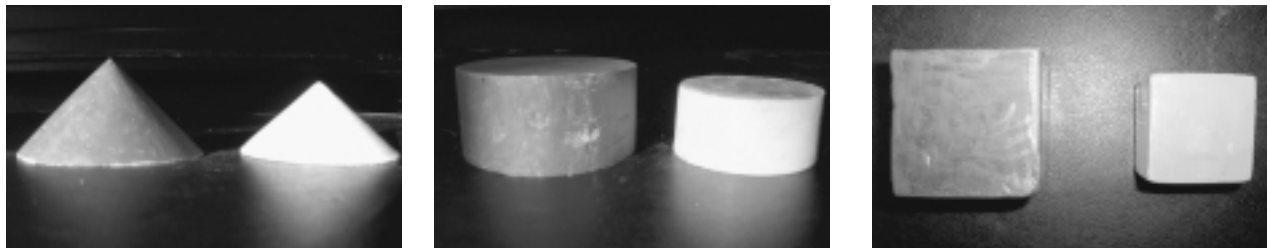
This same challenge, of the doubling of the cube by no means other than construction, cropped up in the attempt to define an algebraic solution for the doubling of the cube, and deriving cubic roots, by Cardano and others, during the the Sixteenth Century, which prompted great consternation among empiricists such as D'Alembert, de Moivre, Euler, Lagrange, and other professed followers of Descartes or Isaac Newton, during the Eighteenth Century. Cardano and

FIGURE 12



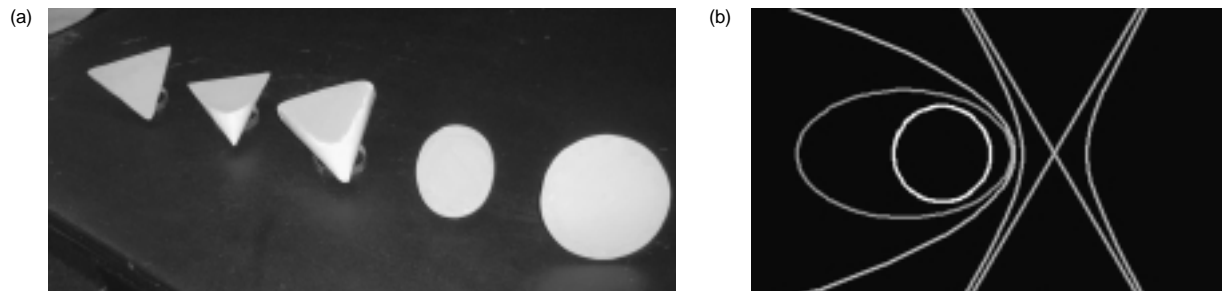
In both (a) and (b), the original volume is on the far right, and the perfectly doubled similar volume is on the far left. In (a), each of the three cones next to the original cone is double the volume of the original. The first to the left is doubled by doubling the height, the second by doubling the area of the base. The cone on the far left was doubled by an equal increase to both the radius of its base and its height, producing a similar cone. In (b), we show the same results for the cylinder: The base of the cylinder third from the right (shown on edge) is doubled.

FIGURE 13



Here we show each original solid with its similar companion of double capacity. Because of the difficulty posed by constructing hollow containers, we realized that if our solids were constructed properly, we could make use of a discovery of Archimedes to determine their volumes.

FIGURE 14



In (a), we show the various conic sections progressing from the horizontal cut, which gives the circle on the far right; to a cut less than parallel with the side of the cone, which results in an ellipse; to the cut parallel with the side, which gives the parabola; to a cut between the angle of the side and vertical, which gives the hyperbola. The final cut shown is that made down the axis of rotation, which reveals the triangle rotated to produce the cone. In (b), we show a schematic produced by Bruce Director to demonstrate Kepler's conception of the conic functions. As the focus moves off to the left, the circle is transformed into an ellipse. At the boundary with the infinite, the ellipse becomes a parabola. The hyperbola is formed on the "other side" of the infinite.

his associates had been confronted with what D'Alembert's advisor de Moivre identified falsely as "imaginary" numbers, which turned up as formal mathematical solutions for the errors arising in the attempt to define cubic roots only algebraically.

The empiricists, the Seventeenth and Eighteenth centuries' followers of the medieval William of Ockham called either Cartesians or Newtonians, reacted to this experience by insisting on locating the physical reality expressed within the

bounds of their axiomatic system of mathematics, and therefore labelled, as "imaginary," the physical action which actually produced observed effects such as the calculated cubic roots.

This is the challenge which led to the 1799 publication of Carl F. Gauss's doctoral dissertation, in which he developed a physical conception of geometry which he later renamed The Fundamental Theorem of Algebra. In their

LaRouche text continues on page 22

to any other cube, so in this way, it is a spherical solid. Look back at the problem of constructing volumes of equal capacity.

There are ways of cheating in constructing a cone or cylinder whose volume is equal to that of a sphere. If you are unconcerned that the solids you produce are similar to your original objects, the problem is as easy as changing the height, or the surface area of the base, of the original. But then you miss the fun of confronting the construction of a series of different cube roots. Even if you try to avoid this difficulty, you can not escape the problem of finding a cube root (and a very strange cube root at that), when constructing a cube with equal capacity to the sphere.

In this experiment with volumes, which is at heart a study of cubes, the

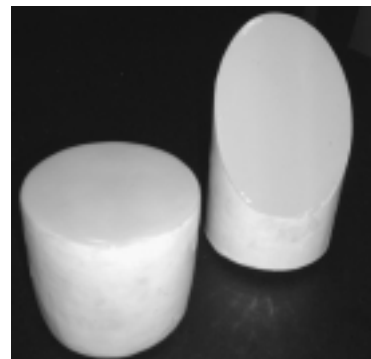
problem of the curved and the straight lurks around every corner (and around every edge). When Kepler spoke, in his *Optics*, about the relationship among the conic functions, looking at the different conic sections as a continuous transformation from the perfectly curved, the circle, to the perfectly straight, the straight line, he was, in truth, depicting the aspects of curved and straight married in the cone itself (Figure 14).

In this regard, the cone and cylinder obviously share this important characteristic, this union of curved and straight, as seen in their sections (Figure 15).

But the cube, which does not appear to have any part of curvature within it, is itself spherical! (Figure 16)

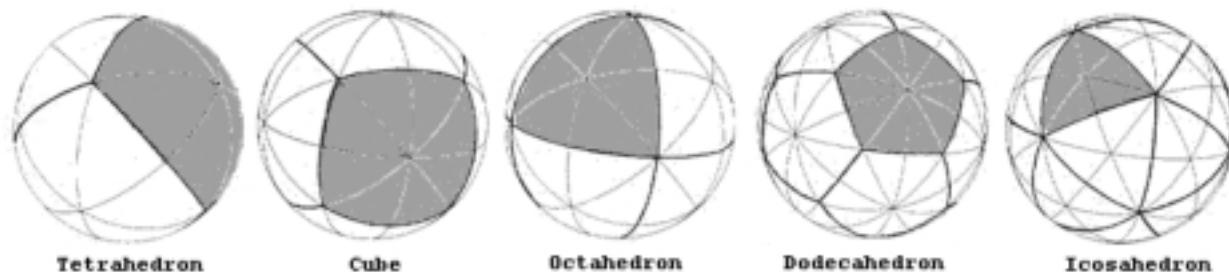
To conclude, consider the torus, so neglected in this initial treatment. Where does it belong? And, how do you construct those cube roots, anyway?

FIGURE 15



Here we show that there are only three different cuts of the cylinder, no matter how you cut it! (The axial cut that produces a rectangle is not shown.) Notice that the cylinder and cone share the circular and elliptical cuts (although in the cylinder all its elliptical cuts are of a special type), but that the parabola and hyperbola are unique to the cone.

FIGURE 16



—The entire Seattle LaRouche Youth Movement was involved in this project. In addition to Niko Paulson, Peter Martinson, and Riana St. Classis, Dana Carsrud, and Will Mederski consistently aided the project's progression to this stage of completion. They helped construct the means of constructing the solids, and helped construct the solids, paint them, epoxy them, and photograph them. And now, we shall all play with them! Photographs were taken by Lora Gerlach, Will Mederski, Dana Carsrud, and Riana St. Classis. Lora Gerlach also provided priceless assistance with navigating the digital flat lands of Photoshop and Word.

Box 3

The Torus and the Sphere

The sequence that represents the volumes of those cubes that a person can build with unit cubes is 1, 8, 27, 64, etc. In the 4th Century B.C., Plato challenged his collaborators to solve an old problem: Build a cube of volume 2. In other words, construct two cubes, one of which can contain exactly twice the amount of material as the other. This means we must find an intermediate cube, not in the sequence of cubes which are generated by unit cubes.

Hippocrates of Chios had demonstrated that each of the normal cubic numbers

in the sequence can be arrived at by a process of geometric growth, in which there are two geometric steps mediating the growth from 1 to the next highest cubic number. For example, doubling produces 1, 2, 4, and 8; and tripling produces 1, 3, 9, and 27. Between each pair of extremes (1 and 8, or 1 and 27) are two geometric means (2 and 4, or 3 and 9, respectively). As a cube doubles from 1 to 8, the edge lengths grow from 1 to 2. But, the two geometric means between 1 and 2 cannot be found on a ruler. In fact, the best one can get by today's calculations, is a close approximation.

Plato, however, did not ask for a close approximation! Archytas, a close collaborator of Plato, discovered the first exact solution to the problem (Figure 1). Archytas *knew* his discovery would produce a doubled cube, because it solved the general problem as posed by Hippocrates. Thankfully, there is a description of Archytas' construction which we can use today to replicate his ancient discovery, by means of the method of *Sphaerics*.

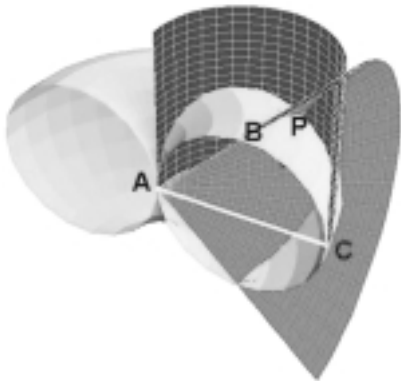
For a youth growing up in the 21st Century, educated inside universities run by Baby Boomers, it's easy for us to believe that Archytas never built his construction. But, this is simply because we've been brainwashed to ignore the

process of production, as a human activity. Most members of the LaRouche Youth Movement *have* built contraptions demonstrating different aspects of the actions in Archytas' construction. In the photo, LYM members in Los Angeles use their Archytas model in a classroom/workshop.

To our knowledge, however, nobody has yet actually built a complete model of the torus, the cylinder, and the cone, all intersecting at the cubic point. The difficulty lies not in constructing the cone or the cylinder, but in constructing the torus. You cannot wrap a piece of paper into the shape of a torus without stretching the paper. We've tried wooden rings, paper circles, slinky toys, and computer graphics, but all of these only give a framework on which to drape a mental surface (Figure 2). But these are *not* actual toruses. Perhaps we should follow the mean advice of Eratosthenes: "Do not seek to do the difficult business of the cylinders of Archytas . . ."

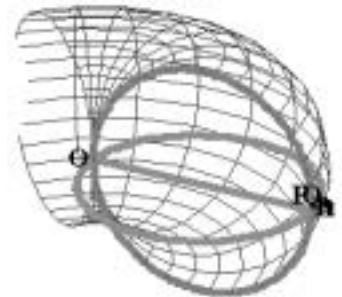
We recently were inspired by the fight

FIGURE 1



Computer graphic representation of Archytas' construction.

FIGURE 2



Computer graphic representation of torus.



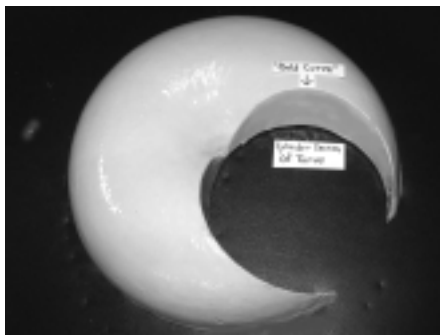
FIGURE 3



The torus-building machine tool, and its product.

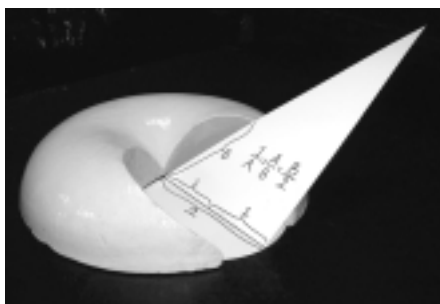
to save the automotive sector in the U.S.A., and we built a machine tool incorporating two layers of circular action, which carves out a toroidal bowl from some drying plaster of Paris. The tool we designed has a stack of compact discs (CDs) secured to the end of a long 3/8-inch bolt, with three CDs glued perpendicularly inside cuts at equal divisions

FIGURE 4



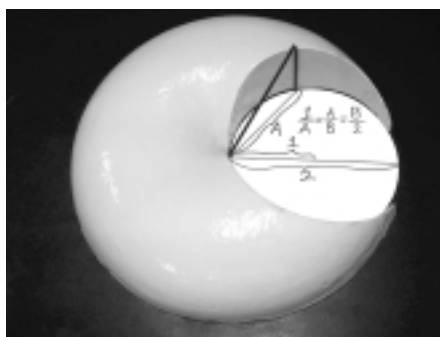
The bold curve, as an intersection between torus and cylinder.

FIGURE 5



The intersection of the cone and the bold curve produces the larger of two geometric means between 1 and 2.

FIGURE 6



The projection down of the intersection between the cone and bold curve, produces the smaller of two means between 1 and 2.

of the CD stack. To these CDs, we glued cardboard semicircles of the desired radius for our torus.

Then, as a large bowl of plaster is drying, we used a hand drill to sweep out a half-torus (Figure 3). We could then use this as a mold, to create positive toruses, one of which we produced with a cylindrical section cut from it.

The intersection of the actions producing the torus and cylinder, gives us a special curve, extending from the center of the torus to a point opposite the center, which Eudemus called the bold curve (Figure 4).

Now, sweeping out a particular conic action intersects this bold curve at a point which, when connected by a line to the center of the torus, results in a length equal to the larger of the two desired geometric means (Figure 5).

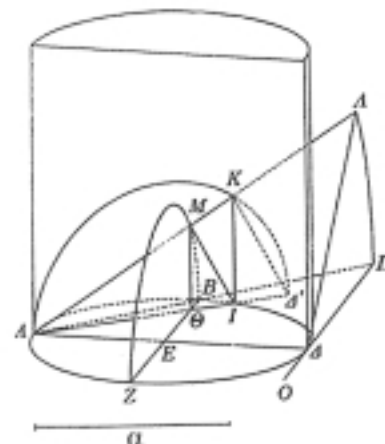
Projecting that intersection directly downward, to a plane that slices the torus in half (like a bagel), one obtains a second point, which, when connected by a line to the center of the torus, results in the smaller mean (Figure 6). If the two extremes, the radius and diameter of the cylinder's base, are 1 and 2, respectively, the shorter and longer means will give you the edge lengths of the doubled and quadrupled cubes, respectively.

Now look back at the problem. We wanted the means to build a doubled cube, and we ended up with a construction, using surfaces of revolution, to find a set of straight lines (Figure 7).

Isn't this strange? The volumes contained by the surfaces depend on a different principle than the volume of the cube. Nevertheless, it is the intersection of these surfaces that gives us means to double the cube. We're using two lower orders of magnitude, to produce a higher-order magnitude. This is like using the right combination of pork chops to construct a New York strip, or finding the right combination of dolphins and chimpanzees that produces a human being. Yet, here we are using lines and surfaces, to build a volume! This is not only strange, but, paradoxical.

Let's think like Archytas—who developed his ideas of mean proportionals from investigating music—and

FIGURE 7



Eudemus's drawing of the Archytas construction. The intersections of the surfaces give straight lines, not volumes!

invert the construction. Perhaps the arrangement of the three circular actions, is determined top-down, rather than bottom-up. In this case, the intersection point is not caused by an adding up of three surfaces, just like a musical interval is not note plus note. Instead, Archytas arranged them to reflect a process that is not continuous in the visible domain. Imagine a cube, growing continuously into a cube eight times the volume, passing through the doubled volume. Archytas' arrangement of actions thus captures two snapshots, the doubled and quadrupled cube, and pulls them from the invisible continuous process, into the visible domain.

The torus, cylinder, and cone are footprints of this act of making the invisible, visible. So is the sphere, which is also a surface generated by two orthogonal circular actions. Thus, the construction of the two means between any two extremes can be represented on the sphere. But, the sphere does not have the ability to generate those means by itself. The construction of the means requires the unfolding of the spherical action, by Man. Metaphorically, Archytas' discovery, and our little machine tool, formed the two means between the invisible domain of continuous cubic growth, and the visible domain.

—Peter Martinson

work in this topical area, empiricists such as Euler and Lagrange, and their followers Laplace and the neo-Cartesian and plagiarist of Abel, Cauchy, flunked the test. (See **Box 4**.)

In the meantime, a number of important developments by

the followers of the work of Cusa had occurred. Most important was the discovery of modern astronomy by a faithful follower of Cusa, Johannes Kepler, and some important work by a friend of Kepler's, the Napier who developed his system of logarithms from the basis of the ancient Pythagorean princi-

Box 4

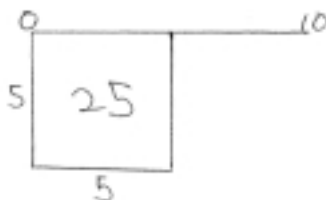
Cardan and Complex Roots

Archytus performed a Promethean act, when he discovered a *Sphaerics*-guided solution to the life-and-death paradox of doubling the cube. For Archytus, that solution lies not in the visible domain of the cube itself, but belongs to a higher domain, where human creativity dances with universal principles, what Gauss has since called the complex domain. From that time to the present, repeated acts of contempt have been perpetrated against Archytus, by those heirs of the legacy of Aristotle and Euclid, who, on behalf of their oligarchical masters, wish to rob man of his fire, and replace it with soulless analytic formulas.

It was more than 1,100 years after Diophantes, the Greek father of algebra, who had developed his mathematics in the dwindling tradition of the Pythagoreans, that Gerolamo Cardan first introduced (in approaching the problem of squaring and cubing) the idea of complex roots, as formal solutions to algebraic problems. For example, if given the equation $x^2 - 10x + 40$, the laws of algebra state that for an equation with rational coefficients, the first coefficient (i.e., 10) will be the sum of the solutions, and the last term (i.e., 40) will be the product of those solutions.

For the notorious gambler Cardan, acting in the empirical tradition of Al-Khwarizmi (famed for the notion of completing the square), this becomes a

FIGURE 1



problem of finding a way to divide a line of 10 units, in such a way, that the two parts multiplied will equal 40 (**Figure 1**).

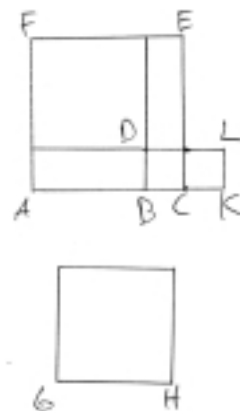
But since the greatest area that can be created through this process (a square) has an area of 25, the problem is considered physically absurd, but algebraically solvable, if we allow for numbers of the form $(a + b\sqrt{-1})$; in this case, $(5 + 15\sqrt{-1})$ and $(5 - 15\sqrt{-1})$. Quantities of this type became known as imaginaries, and they haunted Cardan as he tackled the physical problem of cubing. Unlike Archytus, who asked which complex *action* has the power to produce cubic magnitudes, Cardan started, not with action, but with the sense-certain nature of material cubes and their algebraic derivative.

He laid out his cubic problem thus: "For example, let the cube of *GH* and six times the side *GH* be equal to 20. I take 2 cubes *AE* and *CL* whose difference shall be 20, so that the side *AC* by side *CK* shall be 2 . . . (**Figure 2**)."

From here Cardan's equation for general solutions to cubic problems "falls out" algebraically.

Apply to the equation $x^3 - 12x = 10$,

FIGURE 2

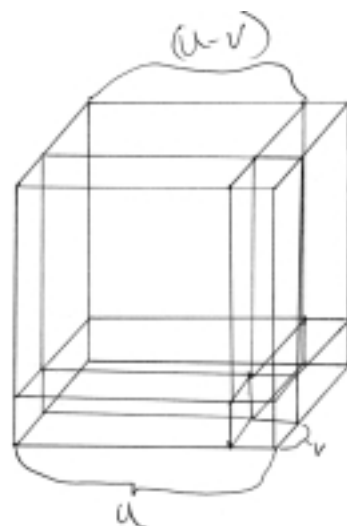


the method prescribed by Cardan, which is in fact purely analytical, despite his request for an initial diagramming of a cube (**Figure 3**):

We let $u^3 - v^3 = 10$ and $u^3 \times v^3 = -64$, and consequently $u \times v = -4$.

$$\begin{aligned} \text{If now we put in } u-v \text{ for } x, \text{ we have:} \\ (u-v)^3 - 12(u-v) &= u^3 - v^3, \\ u^3 - 3u^2v + 3uv^2 - v^3 - 12u + 12v &= u^3 - v^3, \\ &= u^3 - v^3, \end{aligned}$$

FIGURE 3



2. On the significance of the work of Napier, we shall return, at a later point in this report, to examine Gauss's reference to Napier's *Pentagramma Mirificum*, in Gauss's treatment of the subject of hypergeometry, and

Riemann's continuation of that line of investigation as his own development of the principles of hypergeometry.

$$3uv(v-u) = 12(u-v).$$

And since $uv = -4$, then $12(u-v) = 12(u-v)$.

And therefore, $x = u-v$ is in accord with our original premises.

And since $u^3 = 10-v^3 = 10+64/u^3$, and because $u^3v^3 = -64$, we then have $u^6 = 10u^3+64$: a quadratic, that can be solved using the age-old quadratic formula: $-b/2a \pm \sqrt{(b^2-4ac)/2a}$ (a formula easily derived from Al-Khwarizmi's work on completing the square).

Using that formula, we come to the "imaginary" solutions:

$$u = 5 \pm (\sqrt{-156})/2,$$

$$v = -4/[5 \pm (\sqrt{-156})/2],$$

$$x = u-v$$

$$= 5 \pm (\sqrt{156})/2 + 4/[5 \pm (\sqrt{-156})/2].$$

Again, the algebra, applied to what is in actuality a physical problem, has produced something ambiguous and unknowable.

When carrying out algebraic investigations of literal squares and cubes, the occurrence of complex quantities, as solutions, is a total paradox. For what is a negative cube in the material world? (Is $\sqrt[3]{-x^3}$ the edge of a cube whose volume is $-x^3$?) And, even more absurd, what would something like x^4 or x^5 , etc., "look like"? Thus, geometry, when condemned to "flat Earth" three-dimensional Euclidean space, loses the name of action, taking on the character of a stiffened corpse, no longer susceptible to cognitive interaction; and algebra becomes a pseudo-science, practiced to maintain an "ivory tower" fantasy.

The Gambler de Moivre

It was continuing in this depraved tradition, that a close ally and co-conspirator of Sir Isaac Newton, Abraham

de Moivre (whose chief form of employment was as an advisor to the gamblers of his day, much like the bulk of today's mathematicians who work for the various casino-like hedge funds of Wall Street) seems to be the first to have found it convenient to apply trigonometric laws (although with no connection to the circular action from which those laws were born), to his sadistic investigation of the cubic roots. In one particular stab, he begins with what he calls an "impossible binomial" ($a + \sqrt{-b}$), and seeks to find its cubic roots. Knowing, from his intense indoctrination in mathematical textbooks, that the trigonometric equation $4\cos^3A/3 - 3\cos A/3 = \cos A$, associated with the trisection of an angle, could be made to yield 3 solutions, he set out to contort the algebraic equation, for a cubed binomial $(x + \sqrt{-y})^3 = x^3 + 3x^2\sqrt{-y} - 3xy - y\sqrt{-y}$ into a form which is algebraically akin to that of the trigonometric formula. (That is, $4x^3 - 3mx = a = 4(x/r)^3 - 3(x/r) = c/r = 4x^3 - 3r^2x = r^2c$).

Once that's been achieved, de Moivre carries out a series of algebraic manipulations of the trigonometric equation, winds up with three angular solutions, "applies the table of sines," and gets three new fractions, which he then plugs back into his previously derived algebraic equation, fondles it a bit, and ends up with the three desired algebraic solutions, two of which are "imaginary" ($a + \sqrt{-b}$).

So, like Cardan, he winds up with algebraic magnitudes, that if squared, would be said to have produced a negative area—a paradox, and doubly so in this case, in that this was achieved by using circular (trigonometric) func-

tions. But, for de Moivre, whose creativity was crippled by that "drill and grill" abuse at the hands of his "ivory tower" controllers, there is no paradox. The fact that his algebraic investigations lead him to the use of circular functions, where $z = x + iy$ becomes $z = r(\cos\phi + i\sin\phi)$, and finding the cube root takes the form of finding the cubed root of a radius ($\sqrt[3]{r}$) and trisecting the angle ($\phi/3$), is only formally consequential and ontologically unknowable. For de Moivre there is no action, or higher ordering principles at work, only the "imaginary" shadow world idea of algebra and its "right answers."

Unfortunately, due to his obsession with, or better, possession by formal algebra, and his absolute denial of the knowability of the principles of action, characteristic of constructive geometry, the paradoxical occurrence of complex roots, and the handling of them by trigonometric properties, never provoked de Moivre to ask those questions of cause, which spawned the hypothesis made by Gauss, that the "imaginar-ies" were reflections of an action, which is ontologically transcendental.

It was his mind's shackling at the hands of algebraic formalism, which barred him from looking to the physical geometry behind the shadows of his formulas, to discover, that what he had deemed to be "impossible," were in fact the effects of a true physical action. For example, in the physical construction for the trisection of the angle, two of the solutions that would have appeared to de Moivre to be imaginary, are in fact real (Figure 4).

In other words complex numbers are not arithmetic quantities, but rather

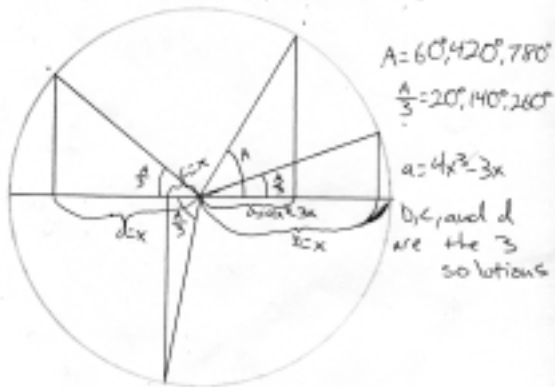
Box 4 continues on next page

Leibniz, Fermat, Pascal, and Huyghens were outstanding contributors. Fermat's discovery of quickest time was the most important of these contributions for defining the principles of a competent physical science. (See **Box 5**.)

The work of Huyghens on the subject of quickest time, was

not the right definition for the principle of quickest time, but it led the way toward the discovery of the solution by the joint effort of Leibniz and his collaborator Jean Bernoulli: Leibniz's fundamental principle of the physical calculus, *the universal, catenary-cued principle of universal physical least action*. The

FIGURE 4

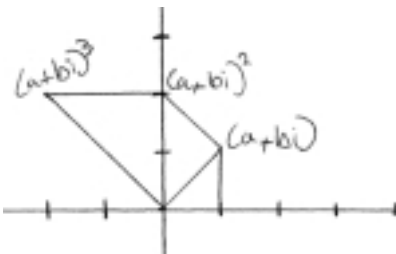


Three solutions to cubic function in the complex domain: Tripling the angle of any of the three solutions of 20°, 140°, and 260° will bring you to the desired 60°.

haunts, of a knowable, higher action, which subsumes the algebra. So it was Gauss, who was left to re-stoke that flame of Pythagorean *Sphaerics*, which had been reduced to smoldering ashes by those followers of the cult of Newton (**Figure 5**).

It was one of de Moivre's students, d'Alembert, who thought he could totally purge science of geometry, by seemingly introducing it in his attempt at a proof of the fundamental theorem

FIGURE 5



Cubing a complex magnitude $(a + b\sqrt{-1})$ in the complex domain, a combination of rotation and extension.

of algebra. In effect, he employs what is commonly known today as the "plug and chug" method of Cartesian point-plotting, of trying to close in, getting infinitely closer to the solution.

So, given the algebraic problem of $x^2 + 1 = 0$, the method of d'Alembert calls for simply plugging all the possible real values in for the variable and plotting the variable as the ordinate and the function as the abscissa (**Figure 6**).

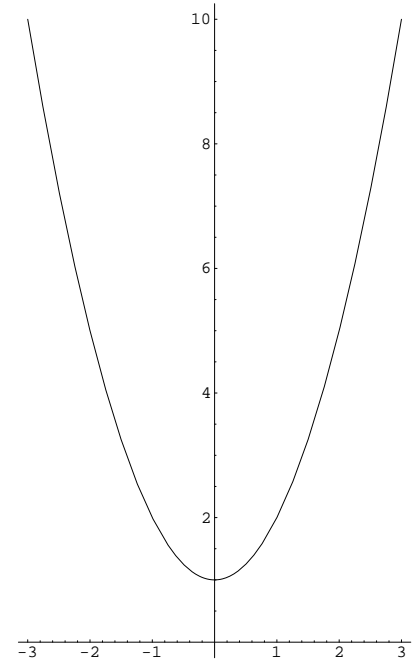
For cases where the reals don't lead to an answer, such as the $x^2 + 1 = 0$ problem, d'Alembert calls upon the magic of the imaginaries, and says we can use quantities of the form $a + b\sqrt{-1}$ to yield solutions. If we plug in all the possible $a + b\sqrt{-1}$ quantities, we produce a curve that does cross the imaginary ordinate, giving us our two answers (**Figure 7**).

Gauss's Critique

To this, Gauss says of d'Alembert's proof: "It is proper to observe, that d'Alembert applied geometric considerations in the exposition of his proof and looked upon X as the abscissa, and x as the ordinate of a curve . . . but all his reasoning, if one considers only what is essential, rests not on geometric but on purely analytic principles, and an imaginary curve and imaginary ordinate are rather hard concepts and may offend a reader of our time."

This is the crux of Gauss's attack on the whole of the works of Euler,

FIGURE 6



Equation $X = x^2 + 1$:

x	-3	-2	-1	0	1	2	3
X	10	5	2	1	2	5	10

d'Alembert, et al., in his 1799 proof of the Fundamental Theorem of Algebra: Their proofs were conspicuously void of constructive geometry, and hence human creativity. At best, they simply investigated that which is, as opposed to asking the question: What has the power to make possible that which is?

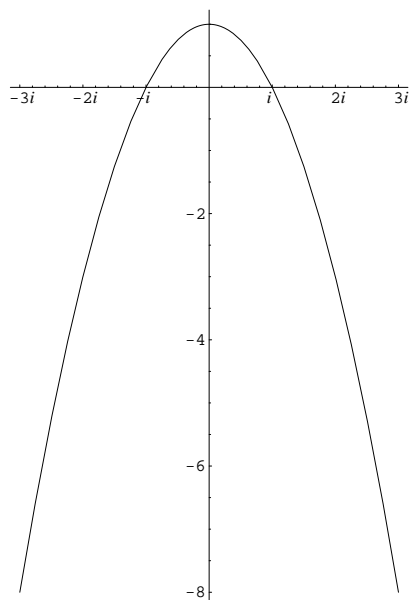
It is no hyperbole to say that this fight, over the challenge of discovering a solution to the paradox associated with the doubling of the cube, is a life-and-death one.

As history has shown, and as LaRouche's discovery has made known, man only survives when he

significance of Leibniz's discoveries, was kept among the active pursuits of science during the Eighteenth Century by, chiefly, a scientist who became a crucial promoter of the cause of American freedom, Franklin's one-time host Abraham Kästner. Kästner was also one of the two most significant

teachers of the young Carl F. Gauss. Kästner was the first to prove in modern times, that a valid physical geometry must be not merely non-Euclidean, but must be recognized as anti-Euclidean, since the rectilinear kernel of assumptions of the Euclidean system, the rectilinear axiomatics, was provably

FIGURE 7



Equation $X = x^2 + 1$:

x	$-3i$	$-2i$	$-i$	0	i	$2i$	$3i$
X	-8	-3	0	1	0	-3	-8

progresses, and he only progresses when he applies his uniquely human power of cognition to those paradoxes which the universe communicates to us. Constructive geometry, in the complex domain, of the tradition of Archytus, through Gauss and Riemann, is the embodiment of those creative acts, which not only express, but also strengthen, that relationship between man and the universe. Any attempt to formalize and to degrade such universal problems of physical geometry to the level of the analytic, is nothing short of a crime against humanity, performed on behalf of those whom Dick Cheney calls master.

—Cody Jones and Chase Jordan

Box 5

Fermat's Principle

What the reason was for the change in light's direction when passing from one medium to another was a major fight in the 17th Century, and it must become so, again, today. Fermat's principle that light's action is determined by the principle of quickest time, was a political statement, a clear attack on the prevalent empiricist thinking, and a call back to the method of Greek knowledge. It demanded a conception of physical science that places man in his proper place—as in the image of, and participating in a single Creation, overthrowing the oligarchical view that placed man infinitely below the incomprehensible caprice of the Olympian gods and human feudal lords.

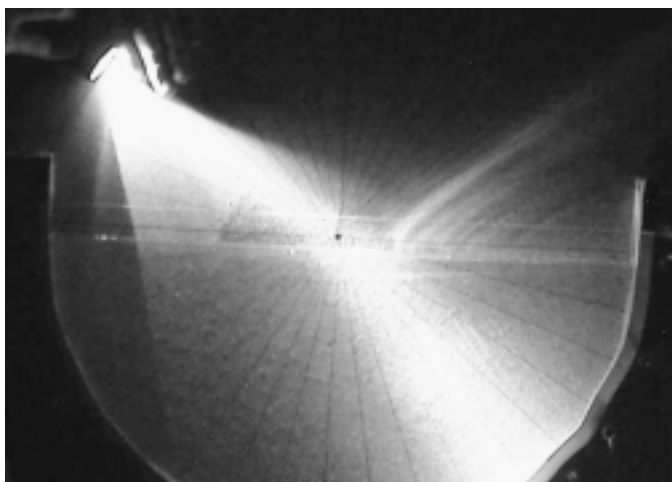
The refractive behavior of light had been a source of study and consternation for centuries, since no simple rela-

tionship between the angles of incidence and refraction could be determined (Figure 1). It was in 1621, that the Dutch investigator Willebrord Snell determined that it is the sines of the angles of incidence and refraction that maintain a constant ratio for a given pair of media, an experiment that is worth carrying out yourself (Figure 2).

Although Snell is correct, this observation of effects does not address itself to cause. Descartes, insisting that light had to be understood as ballistic particles (in opposition to da Vinci, and to keep his purely mechanical outlook) was forced to conclude, erroneously, that light actually sped up upon entering water. He also claimed Snell's discovery as his own! Fermat found this speeding up to be absurd, and sought to determine the *cause* for

Box 5 continues on next page

FIGURE 1



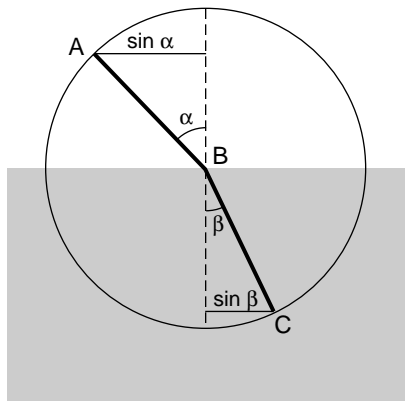
In an experiment conducted by the LYM, the path of light is seen to change direction when it passes from air to water.

absurd.³ (See **Box 6**.)

3. As Gauss implicitly emphasized for the case of János Bolyai, neither of the famous so-called “non-Euclidean” geometries of Lobatchevsky or Bolyai are

equivalent to the anti-Euclidean geometry of Kästner and Riemann. Both Lobatchevsky and Bolyai go only part-way in grasping the argument exposing the falseness of Euclidean geometry as shown earlier by Kästner. It was

FIGURE 2



Snell determined that the ratio $\sin/\alpha : \sin/\beta$ is maintained for two media, no matter at what angle the light hits the boundary.

light's behavior.

To note the sine relationship is good, but to actually assert that this trend is a scientific principle would not be an honest blunder, it would be an admission by anyone who would make that statement, that that person believes principles are unknowable.¹

Fermat sought not to describe the motion of the fish, but the shape of the aquarium in which they swam: He returned to the Greek discovery that light reflected off a mirror takes the path of minimal distance, an experiment worth performing on your own (Figure 3).

Fermat took up this approach, and hypothesized and demonstrated in 1662 that light follows a path of quickest time, rather than shortest distance: As far as the light is concerned, it is always propagating straight ahead by this principle. This hypothesis results in the sine ratio discovered by Snell, but Fermat delivered the child whose form Snell accurately reported.

Fermat politically dared to hypothesize a cause for action in the universe, and the attacks on this daring came

quickly. Claims that knowable ideas and intentions direct the universe were not acceptable by the oligarchical faction. The Cartesian view insisted on a strict separation between ideas of human minds, and the purely mechanical operations of the physical universe. Claude Clerselier, a friend of the by-then-deceased Descartes, wrote, shortly after Fermat's hypothesis:

“The principle you take as a basis for your proof, to wit, that nature always acts by the shortest and simplest path, is only a moral principle, not a physical one: it is not and cannot be the cause of any effect in nature . . . cannot be the cause, for otherwise we would be attributing knowledge to nature: and here, by nature, we understand only that order and lawfulness in the world, such as it is, which acts without foreknowledge, without choice, but by a necessary determination.”

Is Clerselier right? Why is he so insis-

tent? What is he afraid could happen to the practice of science and society if Fermat's principle and approach were generally adopted?

Generalize Fermat's Concept

Find out: Generalize Fermat's concept. Although a relationship of sines is a geometric statement, the intention of quickest time is not, itself, geometric. If this is true for light, what can we say of other processes? Do their geometric effects cause themselves, or must we generalize least action? Must every material event be considered irreducibly as the effect of a non-material, physical intention?

Leibniz writes in his *Monadology*: “Our reasoning is based upon two great principles: first, that of Contradiction, by means of which we decide that to be false which involves contradiction and that to be true which contradicts or is opposed to the false. And second, the principle of

FIGURE 3



LYM members re-creating the Greek discovery of minimal distance for reflected light. The reflective path from eye to eye can be “felt” by a third person as minimizing the required string from one eye to the other.

Riemann, following Gauss's own explorations of a physical hypergeometry, who threw the entire Euclidean and related baggage out of the window in 1854, and went on to develop a general physical hypergeometry. It is that

notion of a physical hypergeometry which I absorbed for the generalization of my own discoveries in physical economy, from Riemann.

Sufficient Reason, in virtue of which we believe that no fact can be real or existing and no statement true unless it has a sufficient reason why it should be thus and not otherwise.”

All understanding of the universe must be of the form of knowledge of generative principles, from whose curvature, all action appears to be “straight.” The development of further principles changes our conception of the shape of what is shortest—as the example of the change from least-distance of reflection to least-time for refraction indicates.

Leibniz, the unique creator of a truly infinitesimal calculus, took up Fermat's position on this question in his first writing on the infinitesimal calculus, and in his *Discourse on Metaphysics*:

“But the way of final causes is easier, and is not infrequently of use in divining important and useful truths which one would be a long time in seeking by the other, more physical way; anatomy can provide significant examples of this. I also believe that Snell, who first discovered the rules for refraction, would have waited a long time before discovering them if he first had to find out how light is formed. But he apparently followed the method which the ancients used for catoptrics, which is, in fact, that of final causes. For, by seeking the easiest way to lead a ray from a given point to another point given by reflection, on a given plane (assuming that this is nature's design), they discovered the equality of angles of incidence and angles of reflection, as can be seen in a little treatise by Heliodorus of Larissa, and elsewhere.

“That is what, I believe, Snell and Fermat after him (though without knowing anything about Snell) have most ingeniously applied to refraction. For when, in the same media, rays observe the same proportion between sines (which is proportional to the resistances of the media), this happens to be the easiest or, at least, the most determinate way

to pass from a given point in a medium to a given point in another. And the demonstration Descartes attempted to give of this same theorem by way of efficient causes is not nearly as good. At least there is room for suspicion that he would never have found the law in this way, if he had learned nothing in Holland of Snell's discovery.”

There is no *scientific* controversy between Fermat and Leibniz and their adversaries Descartes and Clerselier: This is a *political* controversy of the nature of man. While political operatives like Descartes and his followers attempted to describe this change by a non-physical formula which would accurately match the observed path of light, Fermat's approach, and Leibniz's development upon it, was Promethean, and forced a conception of man as a knowledgeable co-creator, discovering principles and implementing them to create new states of nature. Knowledge is solely based on *power*.

—Jason Ross

1. One could just as well make the (admittedly, true) statement that middle schoolers with larger feet are better spellers. Larger feet do not confer orthographic proficiency; the education that comes with being older does. Retrospective musings on the results of completed action in the past are not hypotheses of motive powers.

For Further Reading

Christiaan Huygens, *Treatise on Light*, 1690.

Gottfried Leibniz, *Discourse on Metaphysics*, 1686.

Gottfried Leibniz, “Submission of Differential Calculus,” in D.J. Struik, *A Source Book in Mathematics: 1200-1800* (Cambridge, Mass.: Harvard University Press, 1969).

Oevres de Fermat, V. II, pp. 354, 457, 454, as cited in Laurence Hecht, “Why You Don't Believe Fermat's Principle” (Editorial), *21st Century Science & Technology*, Fall 2001.

The result of Kästner's influence on the youthful Gauss's own adoption of an anti-Euclidean physical geometry, was a discovery which Gauss suppressed from public view, through-

out his later career as a leading physicist of Europe, for justified fear of political persecution on this account. It was Bernhard Riemann, a student of both Gauss and Lejeune

Box 6

Kästner's Argument for Anti-Euclidean Geometry

"If two straight lines, in the same plane, are perpendicular to a third line, then they never intersect. This conclusion flows from the *clear* concept of straight line: for, on one side of the third line everything is identical to the other side, and so the two lines would have to intersect on the other side also, if they intersect on this side. But they cannot intersect twice. . . .

"However, when only one of the two lines is perpendicular to the third, and the other does *not* form a right angle, then do they intersect? And on which side of the third line? . . .

"Why should something *necessarily* occur with an oblique *straight* line, which does not *have* to occur, when one replaces it with a curved line? . . . Thus, the difficulty concerns the distinction between *curved* and *straight* lines. A curved line means, a line in which no part is straight. This concept of a curved line is *distinct*, because the concept of straight line is *clear*; but it is also *incomplete*, because the concept of straight line is *merely* clear."¹

Well, to understand that, you'll have to understand this important parable: An information sciences student at MIT once fell in love with one of his classmates. He watched her every day, all day, as she went about her classes and other work, as she ate her lunch, and chatted with her friends; and so enamored was he that he finally rushed home one day, locked himself in his room and entered all of his observational data into his computer, creating the perfect replica, which he could keep on his desk. He proposed to it, it refused the offer, and he promptly threw himself out of the window into the traffic

below. The young woman, who, unlike her *doppelgänger*, had in reality been equally enamored with him, was not at all depressed, as she had already accepted the marriage proposal of the program she had written as a substitute for him.

Wellington: That's a bizarre story. What's your point?

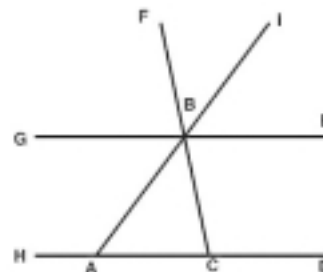
George: The moral of the story is, that you can't mistake your image for the reality you tried to replace with it, no matter how much it seems to fit the facts. This was Abraham Kästner's point regarding Euclid's *Elements*. Every statement contained in it, individually, was the result of a truthful investigation undertaken by the greatest minds of the Pythagorean tradition, but the structure these truths were placed into by Euclid is false, on the face of it and, as a result, leaves us with shaky foundations, to say the least. For instance, is it true that the angles in all triangles add up to two right angles?

Wellington: Well, yes. If we call our triangle *ABC* (**Figure 1**), and extend sides *AC*, *CB*, and *AB* into *HD*, *CF*, and *AI*, respectively, and then simply add the line *GE* parallel to *HD*, we can say that the following things are true:

FIGURE 1



FIGURE 2



Angle *ACB* added to angle *BCD* gives two right angles, as can be seen immediately from the drawing (**Figure 2**), just as, if you turn the paper a little, you can see that angle *FBE* added to *CBE* gives two right angles. But, because lines *GE* and *HD* are parallel, angle *FBE* is equal to angle *BCD*, as can be seen. Therefore, angle *FBE* added to angle *ACB* must equal two right angles, the same as angle *FBE* added to *CBE*, making *ACB* and *CBE* equal. And since, again, angle *HAB* and angle *CAB* together make two right angles, and again, because line *GE* is parallel to line *HD*, angles *GBI* and *HAB* are equal. Therefore, angle *GBI* added to angle *CAB* gives the same thing as angle *GBI* added to angle *ABG*, so angles *CAB* and *ABG* must be equal. But angles *ABG*, *CBE*, and *ABC* together make two right angles, as you can see in the picture; therefore, angles *CAB*, *ACB*, and *ABC*, the three angles of the triangle, are equal to two right angles. And, if you followed that, you'll see that this can easily be shown for every triangle. That's proposition 32 in Book I of Euclid's elements.

George: That's great! And all you needed were parallel lines. But let me ask you, what makes two lines parallel?

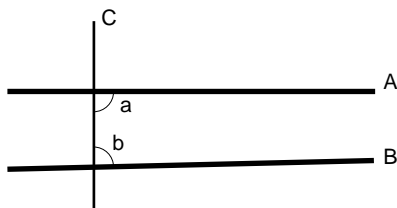
Wellington: That's easy, two lines that don't intersect.

George: Here's how Euclid states it in his 11th Axiom: If a straight line (*C*) falling on two straight lines (*A* and *B*) makes the interior angles (*a* and *b*) on the same side less than two right angles

Dirichlet, who broke science free from the mind-deadening slavery to Euclidean and non-Euclidean geometries alike, in his 1854 habilitation dissertation. (See **Box 7**.)

Thus, competent modern physical science is not only anti-Cartesian, but rests implicitly, and pervasively on an *anti-Euclidean* physical geometry which reflects the combined

FIGURE 3



(180°), the two straight lines, if produced infinitely, meet on that side on which the angles are less than the two right angles (**Figure 3**).

Wellington: That's a pretty rigorous proof.

George: Or, the inverse which Euclid carefully avoids stating: If a and b are equal to 180° then A and B are said to be parallel, never to intersect.

Wellington: Accepted.

George: Let's construct this paradox, so it's very clear. Pull out some paper and draw it. Replicating the image, try it first with the angles a and b being small enough so that your lines A and B intersect and form a triangle on the paper.

Wellington: Easy enough, looks like they intersect to me.

George: All right, now start over, and draw another with angle a and b being a little wider. Do they eventually intersect?

Wellington: Looks good.

George: And once more; this time make it very wide, but not bigger than 179° . Did they cross?

Wellington: No. Well, not yet.

George: Maybe you need another sheet of paper? . . . Try it with a huge piece of paper.

Wellington: Well, because it worked before, I can imagine it makes it there eventually.

George: Like this one here? (**Figure 4**)

FIGURE 4



Wellington: Yes, always maintaining this perpendicular relationship, the lines never get closer to each other; that's what makes them parallel.

George: Well, what about these two lines? They're everywhere the same distance from each other (**Figure 5**). With these, is our previous construction, shown in **Figure 2**, true? (**Figure 6**)

Wellington: Well, the lines have to be straight.

George: What does it mean for lines to be straight?

Wellington: It means that they're not curved.

George: What does it mean for a line to be curved? (**Figure 7**)

Wellington: If a line is straight, it will be the shortest distance between any two points. If it's at all curved, it will be longer than necessary to travel from one point to the other.

George: It's as if we were to walk from here directly to another city, without ever turning.

Wellington: Well, no. In that case the line would be curved, because you're not walking on a flat plane. The real shortest distance between any two points on the Earth would not be along the surface of the Earth, but along the flat plane cutting through the Earth.

George: And how would we know our flat plane was flat, when the Earth wasn't?

Wellington: The plane wouldn't be curved like the Earth. The plane would

FIGURE 5

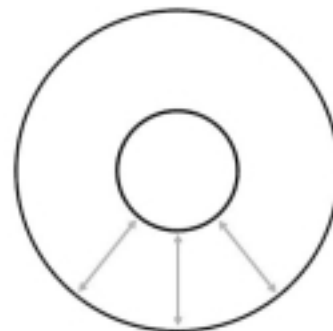
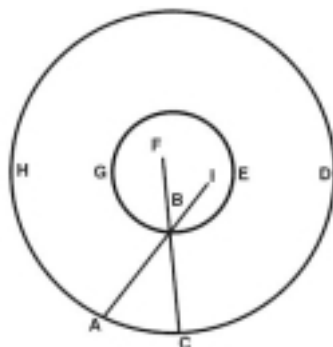


FIGURE 6

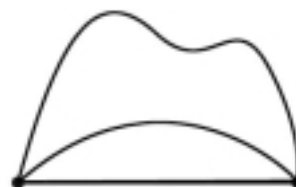


only be two-dimensional, while the Earth would be three-dimensional. You could walk everywhere on the plane by going forward and backward or left and right, without having to go up or down.

George: You mean to tell me that that's not true on the surface of the Earth? Do you need any other directions besides the two—North-South and East-West—when giving someone directions, for instance, or in navigating? How does the Earth not have two dimensions? Or any surface you're

Box 6 continues on next page

FIGURE 7

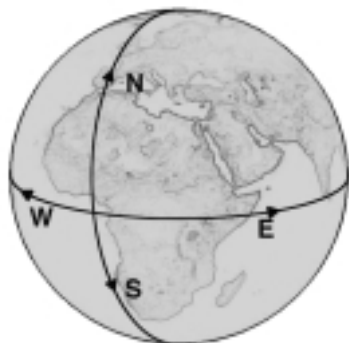


contributions, assembled by Riemann, of Leibniz, Gauss, Dirichlet, and Riemann himself, but which is traceable, explicitly, to the work and influence of Cardinal Nicholas of Cusa,

and to Cusa's predecessors in science among the circles of the Pythagoreans, Socrates, and Plato. (See **Box 8**.)

Now, before turning, in the following chapter, to the crucial

FIGURE 8



standing on for that matter? (Figure 8)

Wellington: No, curved surfaces involve a vertical motion as part of the other two motions. We'll use an example with lines instead of surfaces, which makes the same point. For the straight line, you only need to go one direction, over. But for the curved line you need to go over, and then up. You can get everywhere on the straight line with one dimension, but the curved line takes two. (Figure 9)

George: But you just drew "up" relative to a straight line. And we still don't know what a straight line or a flat plane is yet. What's more, if you took that picture and turned it upside down, we could say that the thing you called curved only went in one direction, North-South say, but that the distance from it of the thing you called flat was changing constantly. Over, and then up. By your definition, that would make the curved line one-dimensional, and

the flat line two-dimensional. (Figure 10)

Wellington: Wait, now I'm confused, this is even more bizarre than that story you started out with.

George: Well, it's exactly what Abraham Kästner said about the problem we're having: "Thus the difficulty concerns the distinction between curved and straight lines. A curved line means a line in which no part is straight. This concept of a curved line is *distinct*, because the concept of straight line is *clear*; but it is also *incomplete*, because the concept of straight line is *merely* clear."

It seems very clear to us what curved and straight are, and as a result we don't bother to ask the question. What we run into when we ask this question, is the debilitating brainwashing which was imposed on ancient Greek geometry by Euclid in creating his formal (prison) system. Kästner challenged this arbitrary authority, provoking his student, Carl Friedrich Gauss, to finally answer the question—"What is curvature?"—decisively.²

—Sky Shields and Aaron Halevy

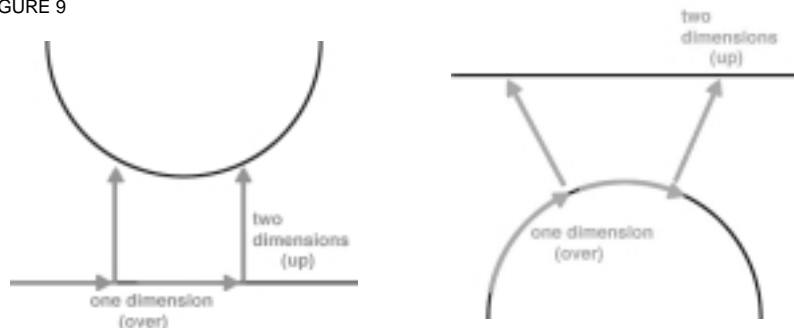
1. "On the Conceptions that Underlie Space," by Abraham Kästner, 1790. A translation can be found of relevant paragraphs in *Fidelio* magazine, Spring/Summer 2004.

2. See the following source material: "General Investigations of Curved Surfaces" by C.F. Gauss, 1827.

"Copenhagen Prize Essay" by C.F. Gauss, 1824.

Elements by Euclid, Dover Edition.

FIGURE 10



Box 7

Gauss, Bolyai, and Anti-Euclidean Geometry

"I would also note that I have in the last days received a small paper from Hungary on Non-Euclidean geometry, wherein I find reflected all of my own ideas and results, developed with great elegance—although for someone to whom the subject is unknown, in a form somewhat hard to follow, because of the density. The author is a very young Austrian officer, the son of a friend of my youth, with whom I discussed this theme very much in 1798, although then my ideas were much further from the development and maturity, that they have attained through this young man's own reflection. I hold this young geometer v. Bolyai for a genius of the first order."

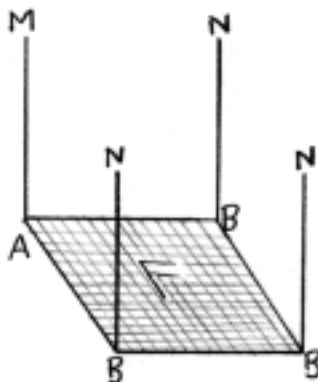
—Gauss to Gerling, Göttingen, Feb. 14, 1832

János Bolyai's book, *The Science Absolute of Space*, billed itself as "exhibiting the absolutely true science of space, independent of the eleventh axiom of Euclid, (which cannot be decided a priori), with the geometrical quadrature of a circle in the case of its falsity." His method of investigation was the following:

Take all lines BN parallel to a given line AM , and perpendicular to the line connecting their endpoints B and A , and the complex of such points B will form a surface, F (Figure 1).

Transform plane F such that all BN cut AM in A : Now, rather than maintaining the assumption that parallel lines never intersect, let us assume, instead, that they do (and, as Bolyai proves, nec-

FIGURE 1



essarily in the same point N). Our surface F becomes something different (Figure 2):

Bolyai then proves "... [I]t is evident that Euclid's Axiom XI and all things which are claimed in geometry and plane trigonometry hold good absolutely in F , L lines being substituted in place of straights: therefore the trigonometric functions are taken here in the sense as in Σ ..."

But, he demonstrates that several par-

FIGURE 2

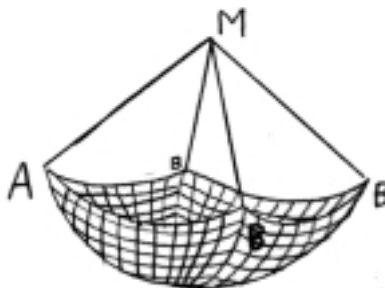
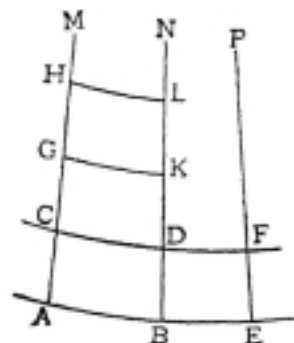


FIGURE 3



adoxical things become possible, such as that there are cases where the lines of area $AMEP$, although larger than $AMBN$, can be moved, without stretching, to fit exactly over the lines of the latter (Figure 3).

With Euclid, there can be no such mapping; however, Bolyai has shown this to be possible even with a congruency of $AMEP$ with $AMBN$, resulting out of parallel lines "... which is indeed singular, but evidently does not prove the absurdity of S [S = Bolyai's geometry]."

Abraham Kästner's task of constructing a geometry free of the parallel postulate, however, had remained unfulfilled by Bolyai's work. Gauss, although impressed by the work of this young man—which exhibited results that he had obtained many years prior, but never published—recognized that Bolyai, although attempting to undertake a revolutionary investigation into the nature of physical space, neglected to investigate the nature of the tools used in that investigation. The fundamental questions concerning the actual, ontological, existence of straight lines and curves were never questioned, but rather treated as playthings handed down by God.

Gauss's Letters on Anti-Euclidean Geometry

The following letters were Gauss's method of working his contemporaries through the difference between a Non-

Box 6 continues on next page

Euclidean geometry as a mere mathematical model, and Anti-Euclidean geometry as the only truly physical geometry. (These letters can be found in *F. Gauss, Werke*, Band 8 (Göttingen, 1900.)

“All my efforts to find some contradiction, some inconsequence in this Anti-Euclidean geometry have been fruitless, and only one thing therein resists our understanding; that is, that, were it [Anti-Euclidean geometry] true, there must be in space some linear magnitude (though to us unknown), determined in and of itself. However I suspect, in spite of the meaningless word-wisdom of the metaphysician, that we actually know too little or nothing at all about the true nature of space, as to be allowed to mix up that which seems unnatural to us, with the absolutely impossible. Were the Anti-Euclidean geometry the true one, and the above mentioned constant in a reasonable relation to such magnitudes which lie within the domain of our measurements on the Earth or lie in the sky, one could ascertain them *a posteriori*.”

—*Gauss to Taurinus*, Nov. 8, 1824

“Anti-Euclidean geometry contains nothing contradictory, although some people at first will consider many of its results paradoxical—the which, however, to consider as contradictory, would be a self-deception, arising from an early habituation to thinking of Euclidean geometry as rigorously true. . . . There is nothing contradictory in this, as long as finite man doesn’t presume to want to regard something infinite, as given and capable of being comprehended by his habitual way of viewing things.”

—*Gauss to Schumacher*,
July 12, 1831

“In order to treat geometry properly from the beginning, it is indispensable, to prove the possibility of a flat plane; the usual definition contains too much, and actually implies surreptitiously a Theorem already. One must wonder, that all authors from Euclid until most recent times worked so neglectfully:



János Bolyai (1802-1860)

Alone this difficulty is definitely of different nature than the difficulty of deciding between Σ [Euclidean geometry] and S [Bolyai’s Non-Euclidean geometry], and the former is not hard to resolve.”

—*Gauss to Farkas Bolyai*,
March 6, 1832

“Yet another subject which I have been thinking on during my scant free time, which for me is already almost forty years old, [is] the first foundations of geometry. . . . Here also have I consolidated quite a lot, and my conviction that we cannot fully lay the foundations of geometry *a priori*, has, where possible, become even firmer. Meanwhile I shall probably not come to publishing my very extended investigations for a long time, and perhaps this shall never occur during my lifetime, as I am fearful of the screeching of the Bötians, were I fully to speak out on my views. However it is curious, that apart from the known gap in Euclid’s geometry—to fill which all efforts till now have been in vain, and which will never be filled—there exists another shortcoming, which to my knowledge no one thus far has criticized and which (though possible) is by no means easily remedied. This is the definition of a plane as a surface which wholly contains the line joining any two points. This definition contains more than is necessary to the determination of the surface, and tac-

itly involves a theorem which must first be proved.”

—*Gauss to Bessel*, Jan. 27, 1829

“My purpose had been, as regards my own work, of which there is yet little on paper, to let nothing of it be known during my lifetime. Most people have no correct sense at all, as to what the crux of this matter is, and I have found only few people, who have taken up that which I have shown them, with any particular interest. In order to do that, one must have first rightly felt what is actually missing, and most people are totally unclear on this. Rather it was my intention, to bring everything to paper over time, so that it would at least not go under with me.”

—*Gauss to Farkas Bolyai*,
March 6, 1832

“... [T]he path which I have taken, does not lead so much to the desired end, which you assure me you have reached, as to the questioning of the truth of geometry. Although I have found much which many would allow as a proof, but which in my view proves nothing (for instance, if it could be shown that a rectilinear triangle is possible, whose area is greater than that of any given surface), and therefore I am in a position to prove the whole of geometry with full rigorousness. Now most people, no doubt, would grant this as an axiom, but not I; it is conceivable, however distant apart the three vertices of the triangle might be chosen, that its area would yet always be below a certain limit. I have found several other such theorems, but none of them satisfies me.”

—*Gauss to Bolyai*, Dec. 16, 1799

“It is easy to prove that, if Euclid’s geometry is not the true one, there are no similar figures whatsoever: The angles in an equilateral triangle are also different as regards the length of the sides, about which I find nothing absurd. Then the angle is a function of the side and the side a function of the angle—naturally such a function, which at the same time contains a fixed line. It seems somewhat paradoxical, that a fixed line could simultaneously be possible *a priori*; I

FIGURE 4



however find nothing contradictory in that. It is even to be desired, that the geometry of Euclid not be the true one, as we would then have *a priori* a general measure, e.g., one could take as a unit of space the side of that equilateral triangle, whose angle = $59^{\circ}59'59''.99999$.” (Figure 4)

—Gauss to Gerling, April 11, 1816

Riemann’s Crucial Contribution

In 1854, the year before Gauss’s death, it would be his student Bernhard Riemann who, in presenting his habilitation dissertation, would lay the “Hypotheses Which Lie at the Foundations of Geometry” and finally fulfill Kästner’s request for a truly Anti-Euclidean geometry:

“If one premise that bodies exist independently of position, then the measure of curvature is everywhere constant; then from astronomical measurements it follows that it cannot differ from zero; at any rate, its reciprocal value would have to be a surface in comparison with which the region accessible to our telescopes would vanish. If, however, bodies have no such non-dependence upon position, then one cannot conclude to relations of measure in the indefinitely small from those in the large. In that case, the curvature can have at every point arbitrary values in three directions, provided only the total curvature of every metric portion of space be not appreciably different from zero. . . . Now however, the empirical notions on which spatial measurements are based appear to lose their validity when applied to the indefinitely small, namely the concept of a fixed body and that of a light-ray; accordingly, it is entirely conceivable that in the indefinitely small the spatial relations of size

are not in accord with the postulates of geometry, and one would indeed be forced to this assumption as soon as it would permit a simpler explanation of the phenomena.

“The question of the validity of the postulates of geometry in the indefinitely small is involved in the question concerning the ultimate basis of relations of size in space. In connection with this question, which may well be assigned to the philosophy of space, the above remark is applicable, namely, that while in a discrete manifold the principle of metric relations is implicit in the notion of this manifold, it must come from somewhere else in the case of a continuous manifold. Either then, the actual things forming the groundwork of a space must constitute a discrete manifold, or else the basis of metric relations must be sought for outside that actuality, in colligating forces that operate upon it.

“A decision upon these questions can be found only by starting from the structure of phenomena that has been approved in experience hitherto, for which Newton laid the foundation, and by modifying this structure gradually under the compulsion of facts which it cannot explain. Such investigations as start out, like this present one, from general notions, can promote only the purpose that this task shall not be hindered by too restricted conceptions, and that progress in perceiving the connection of things shall not be obstructed by the prejudices of tradition. This path leads out into the domain of another science, into the realm of physics, into which the nature of this present occasion forbids us to penetrate.”

—Sky Shields
and Daniel Grasenack-Tente

Box 8

Hypergeometry

Gauss and his student Riemann insisted that the physical universe must be characterized by an anti-Euclidean hypergeometry. Such notions of hypergeometry cannot be directly visualized; nevertheless, when the higher functions associated with physical action, such as elliptical and Abelian functions, are represented in the complex domain, the essential physical-geometrical characteristics of these hypergeometries become clear. As both Gauss and Riemann emphasized,

such hypergeometries are never flat, but are characterized by a changing curvature and an increasing density of singularities.

Figures 1-3 are Gauss's representative drawings of such negatively curved hypergeometric manifolds. Figures 4-6 are Riemann's illustrations of the spherical form of such hypergeometries. Figure 7 is Riemann's representation of a negatively curved hypergeometry.

—Bruce Director

FIGURE 1

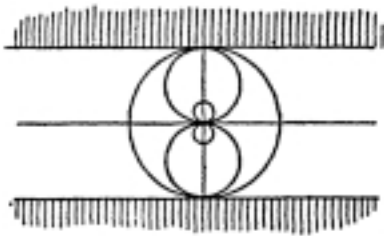


FIGURE 2

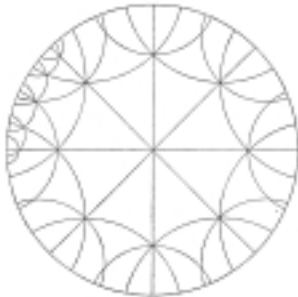


FIGURE 3

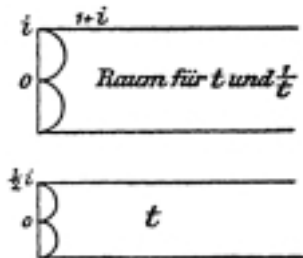


FIGURE 4

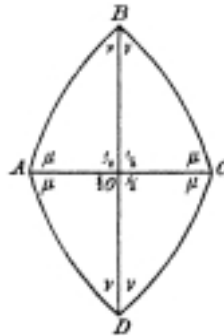


FIGURE 5

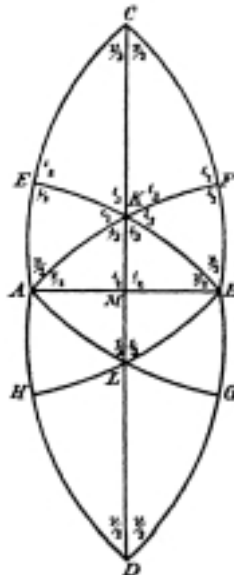


FIGURE 6

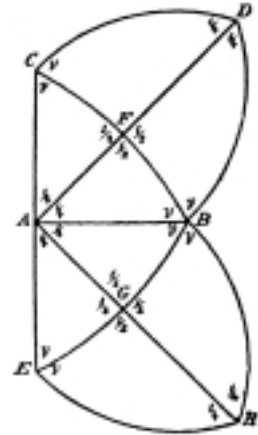
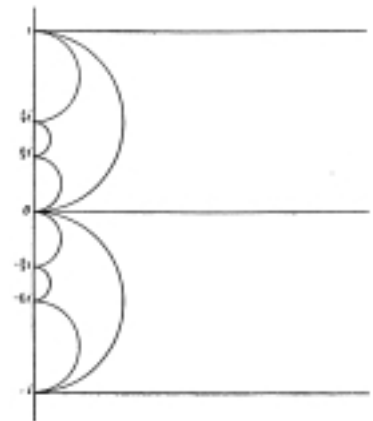


FIGURE 7



The ‘Enlightenment’: Politics and Science

The 1714 accession of King George I to the newly established throne of the United Kingdom, and the death of Leibniz in 1716, three years before the birth of Leibniz’s fellow-Saxon, Abraham Kästner (1719-1800), mark a crucial dividing-line within the history of Europe’s Eighteenth Century as a whole.⁴ The division which generated the conflict between the Gauss of 1799 and the Newtonian reductionists, was essentially political first, and mathematical only second, a political issue which had much to do with the same causes which drove the patriots of the North American English colonies to revolt against the British monarchy, which had, in the colonists’ eyes, betrayed them to the predatory lurches of British Lord Shelburne’s ever-lecherous British East India Company.

The triumph of the Anglo-Dutch Liberalism of the British East India Company, was a cultural and political, as much as moral catastrophe for the national interests of England, Scotland, and Ireland. It was not Britain as a nation which triumphed under George I and his immediate successors; it was an international, Anglo-Dutch cabal which was then openly named “The Eighteenth-Century Venetian Party,” an international slime-mold-like aggregation of private financier entities, rooted in Venice and continuing the Venetian tradition as the Venice-like, imperial maritime-financier power of the combined Atlantic, North Sea, and Baltic region, with the Indian Ocean soon to be added.

Earlier, during the reign of England’s Queen Anne, Leibniz, in addition to being the leading scientist of his time, had become a very important and influential factor in the English politics of the opponents of the predatory Anglo-Dutch Liberal faction represented by the party of the monstrous William of Orange. The Orange party of that time used the followers of René Descartes, the Netherlands-trained opponent of Leibniz’s sometime former sponsor, France’s Jean-Baptiste Colbert, to synthesize a pseudo-genius, using as their synthetic stage-hero the black-magic faddist known as Isaac Newton. It can be conceded that Newton existed as a matter of a living piece of flesh, but, the Newton of the classroom myth was only, so to speak, a synthetic personality created by a committee.⁵

The operation to create the synthetic scientific personality of Newton, was sparked by a sly Venetian abbot, Antonio Conti, operating from Paris, who coordinated the sly crafting of the public reputation of the synthetic Newton. In coopera-

tion with the notorious Voltaire, Conti, until his death in 1749, built up a network of Leibniz-hating, virtual Newton clubs on the map of the continent of Europe, clubs which included the gaggle at Berlin around Maupertuis, Euler, and Lagrange, during a relevant period of time. Conti, an avowed devotee of the teachings of Descartes, used the Cartesian model to build up a cult of avowed followers of the synthetic figure of Newton, as the synthetic, English “Descartes,” both in Britain and on the continent.

The resulting division of both scientific and pseudo-scientific opinion throughout post-1714 Europe, between the factions of the Newton cult and the work of Leibniz, has been the source of the principal continuing controversy in nominally scientific circles from that time to the present day. Nothing better demonstrates the true nature of this scientific controversy, than shifting the discussion of the issues of method from the domain of abstract, virtually Laputan disputes within the ivory-tower domain of academic algebra, to the real-world subject of economic history studied from the standpoint of what Leibniz first established as the science of physical economy.

The subject of any sane study of economy, is human behavior, not a mechanistic Cartesian’s fantasy-world based on throwing a child’s marbles into Euclidean empty space. Human behavior is a reflection of the role of the creative powers of the individual mind in recreating man’s relationship to man and nature on a higher level. Cartesian behavior, on which the method of the arguments of the empiricists, Marxists, positivists, and existentialists depend, is mechanical. When the idea of science is shifted in its implicitly employed definition, from Cartesian to dynamic forms of mathematical-physical space, the issues of the Newton cult became axiomatically clear; from that standpoint, the attempt to explain a dynamic system, such as human behavior, from the standpoint of mental marbles lost in empty space, the essential fraud of the Cartesian (e.g., “Newtonian”) dogma becomes immediately clear. Since the practice and practical outcome of physical science, is also human social behavior, nothing is lost to science if the spectre of Newton is prudently released to play his more appropriate, native role in the dramatic company of Marat and de Sade—and of that would-be Mephistopheles of the Eighteenth Century, Voltaire.

The effect of the children’s trick games played upon the credulities of the duped followers of the Descartes-Newton cults, was actually intended to be essentially political, rather than expressing any genuine concerns with the issues specific to a formal scientific debate.

That political issue of the Eighteenth Century was not exactly new; we find its origins within European civilization in ancient Greece, as echoes of the celebrated division between the Athens of the famous Solon and the Lycurgus code of Sparta, a Spartan code which had been designed by the notorious cult of the Delphi Apollo. The political issue of that divi-

4. For the identification of these connections we remain actively indebted to the discoveries of our late collaborator and professional historian H. Graham Lowry, who tracked down the “missing link” in the continuity which underlies Leibniz’s influence in shaping the conceptions of law expressed in the 1776 Declaration of Independence and 1789 Federal Constitution.

5. The exposure of Newton as a black magic faddist was made by John Maynard Keynes, who had been entrusted with opening what Britain’s superstitious set had much sought as the wondrous content of Newton’s chest of papers. Keynes’ proffered conclusion was, in effect, shut the chest, and keep it closed, all for the sake of Newton’s reputation.

sion was fairly summed up in the middle section, *Prometheus Bound*, of Aeschylus' *Prometheus* trilogy, in which the evil head of the polytheist cult of Olympus, Zeus, condemns Prometheus to perpetual torment, rather like the procedures enjoyed at Cheney's and Rumsfeld's pens at Guantanamo and Abu Ghraib in spirit, on the charge that Prometheus had committed the crime of having disclosed the use of fire to ordinary human beings.

The purpose of such reactionary political games as that of the mythical Zeus or the neo-Roman Empire and medieval, *ultramontane*, Crusader coalition of Venetian bankers and Norman chivalry, was to reduce the mass of human beings to a cattle-like political and intellectual condition, in which the many of society could be herded as tamed cattle are herded, according to the pleasure of the relevant Lockean shareholder, or the Physiocratic dogma of Quesnay and Turgot. To maintain the largest portion of the population of some section of the world in cattle-like subjugation, it is necessary to suppress that spark of creativity which is peculiarly characteristic of the potential of the human individual, but not the beasts. Under that condition, great masses of people can be herded like cattle, especially with the aid of a corrupt mass-media of the sort encumbering societies today. Such methods of virtual cattle-herding of masses of human beings, have been customary throughout long periods of known history to date.

Freedom for human beings, is not a state of affairs in which all pigs might seek to become equal, but rather a state in which men and women in general consciously practice the *natural-lawful* use of those powers which distinguish man and woman as in the likeness of the Creator, as creative beings in the sense of the leading Pythagoreans, Socrates, and Plato, and of Nicholas of Cusa, Kepler, Fermat, Leibniz, J.S. Bach, and so on. These powers express the essential qualities of true human beings in their practice, as their naturally given potential. Permit the individual's knowledge of that potential within himself or herself, and he can not be kept in servitude for long. Implicitly, the Olympian Zeus of Aeschylus' drama understood this, as did the priests of the Delphi Apollo's loan-sharking cults of sophistry and helotry, and the heirs of that latter cult today. This potential within the typical individual member of society, is what prompts the oligarch's most dreadful fears.

Those and related political implications of competent physical science, are inextricably associated with the idea and relevancies of the mathematical-physical concept of power; a concept associated with the legacy of the physical science of Sphaerics practiced by the Pythagoreans, Socrates, and Plato. The political issues underlying the devastating 1799 attack by Carl F. Gauss on the hoaxes of such followers of the Cartesian reductionist de Moivre, as the Newton cultists D'Alembert, Euler, and Lagrange, are a direct, modern reflection of the issue of the ancient quarrel of the science of the Pythagoreans, Socrates, and Plato, with the legacy of our ancient reductionists such as Aristotle and the Euclideans. Now, as then, as

Eratosthenes would agree, the pivot of the controversy has been the Delian paradox addressed by Archytas' constructive-geometric doubling of the cube according to the essential principle of *Sphaerics*.

The efforts to wreck the progress which had been resurgent in the aftermath of the 1648 Treaty of Westphalia, became known as "The Enlightenment": the illumination of European society by the burning of its cities, towns, and farms in wars. To understand how this has affected the history of modern science and economy to the present moment, a relevant, crucial aspect of modern history must be taken summarily into account at this point in our report.

A Dividing Line in Culture

The significance of the 1714-1716 interval as a singularity of Eighteenth-Century European development, was made emphatically clear, in the form of a kind of shameless confession, with the appearance of the celebrated *Decline and Fall of the Roman Empire*, written by Lord Shelburne's lackey Gibbon. The intention which Gibbon expressed was already the intention of the financier interest represented by his employer, Lord Shelburne. Gibbon's task was to craft a rationalization for what his employer's association, the Anglo-Dutch, British East India Company, was already in the process of doing.

The underlying issue was the same expressed by France's Louis XIV, in allying with France's traditional enemy, the Fronde, against the heir of Cardinal Mazarin, Jean-Baptiste Colbert. "Sun King" Louis XIV, the model for the state-church-based imperialism of the Emperor Napoleon Bonaparte later, was not merely the enemy of the Anglo-Dutch Liberal forces of Europe. The precise fact of the matter, is that, whereas Mazarin and Colbert, like Nicholas of Cusa, Jeanne d'Arc, and France's Louis XI, were dedicated to establishing a system of sovereign nation-state republics, called *commonwealths*, based upon the natural-law principle of the general welfare, both Louis XIV and his Anglo-Dutch Liberal foe were quarreling over which of the two would become the Venetian-style imperial successor of the ancient Roman Empire.

This war set a pattern which has been the dominant feature of the military and related conflicts within Europe from that time to the present moment of writing: the struggle by the Anglo-Dutch Liberal forces and their imperial maritime tradition, to preempt any challenge to the City of London's financial-imperial authority, by organizing wars, chiefly, among the potential continental rivals of that British imperial power based in London's imperial domination of the world's monetary-financial system.

This was the meaning of the British East India Company's orchestration of the so-called "Seven Years War," which weakened not only Britain's rival France, but all continental Europe, to the degree London could seize, and absorb the earlier

French monarchy's claims to imperial power.

This experience of the war of the Netherlands with Louis XIV, and the power London grabbed as its share of the spoils of the Seven Years War, served as the precedent for London's willful orchestration of the career of London's nominal enemy, the Emperor Napoleon Bonaparte, to destroy continental Europe, through Napoleon's wars, in such a degree that London, as it had intended, emerged in 1815 as the dominant partner of the world, temporarily sharing claims to world imperial power with Metternich's already decaying Habsburg regime.

This was the same thinking behind Lord Palmerston's sponsorship of, and continuing control over the revolutionary Young Europe organization of such assets as Mazzini, and such protégés of Mazzini as Karl Marx and Marx's rival Bakunin.

This was the policy guiding London's role, under Lord Palmerston, in putting Lord Palmerston's choice, Napoleon III, on the French imperial throne; but, then came Britain's orchestration of the wars of Prussia in Bismarck's favor, to, then, prepare to destroy Bismarck and his Germany with preparations for a new general war, like the Seven Years War, throughout continental Europe: World Wars I and II.

So, at the moment of President Franklin Roosevelt's death, London took increasing control over the shaping of U.S. pro-colonialist foreign policy under Truman, to such effect that from the mid-1960s on, what had been the greatest nation-state power the world had ever known, has been systematically self-destroyed by the influence of London and its Wall Street allies, to an effect like that which Cotton Mather described, "We are shrunk," almost to nothing, in viewing his London-ruined Massachusetts at the beginning of the Eighteenth Century.

Focus on the key methods which the Anglo-Dutch Liberals and their U.S. accomplices employed to attempt to destroy the U.S.A., in the way they have nearly succeeded in that during the recent forty-odd years since the assassination of President John F. Kennedy. The most typical instruments of the process of destroying the U.S.A. over the long term, from within, were the methods of the Congress for Cultural Freedom in not only destroying the culture of the U.S.A., but in focussing that attack on what was intellectually the most vulnerable section of the population, the generation represented by the children born (chiefly) during the 1945-1950 post-war interval.

That operation against the U.S.A.'s "Baby Boomer" generation, and, also, similarly, the comparable portion of the populations of Europe, has been, in essential respects, a copy of the methods which the Babylonian priesthood deployed, through its agent, the Delphi Apollo cult, to transform the relevant upper social layer of the "Baby Boomer" generation of ancient Athens into a writhing mass of sophistry which plunged itself into the self-destructive process of the Peloponnesian War.

Today, so, the faction behind U.S. Vice-President Cheney has used the most brutish sophists of the United States of our time, the "religious right" and its like among the secularist "neo-conservatives," to engage the United States in spreading endless, futile warfare through which the U.S.A. destroys itself and its influence within the world at large.⁶

The recently urgent need of the United States to free itself from the shameful obscenity of Lynne Cheney's oafish husband, with his numerous military-service deferments, one for pregnancy, does not imply that he should be regarded in any sense as either a great warrior, or an independent force within our nation's life. He is merely a lackey of the interests associated with former U.S. Secretary of State and familiar of Pinochet and Henry A. Kissinger, George Shultz, and the circle behind London's Tony Blair, which have deployed him. It is those Venetian-style financier interests which own him, which are the true enemy of our republic. Therefore, we should not regard him as a warrior, but simply the brutish mere tool of a financier cabal, a figure who substitutes the quality of mad-dog viciousness for intelligence; but, thereby, he does precisely what his masters have expected of him in the process of his destroying himself.

Such are those traditional ways which the greatest fools of the Eighteenth Century, and their later admirers, named, so perversely, "The Enlightenment."

In the case of the Peloponnesian War, the root of those wars which destroyed the power of Athens, can be traced, as Plato traces this implicitly in his *Parmenides* dialogue. From the high points of Ionian culture as expressed or reflected by Thales and Heraclitus, to the rise of the Delphic sophists and their aftermath as Aristoteleanism and Euclid's program, there was a constant thrust, aimed always against the influence of the Pythagoreans and their cothinkers, and always focussed, as from Delphi and the Eleatics through Aristotle, against the scientific method of *Sphaerics*.

There is a later parallel for this in the aftermath of the reform of the Roman Empire by the Emperor Diocletian. When it was finally recognized by Diocletian and his protégé Constantine, that Christianity could not be stamped out among the Greek-speaking population by forceful methods later emulated by Spain's Grand Inquisitor, the religious wars of 1492-1648, and the revival of the terrorist methods of Spain's Grand Inquisitor Tomás de Torquemada, by the seminal Martinist-Synarchist Count Joseph de Maistre, and by Mussolini, Hitler, and Franco. This modern legacy of terrorist methods represented the use of the same Delphic methods incorporated in the creation of the ancient Roman republic. It was the methods of the Delphic imperial Pantheon, the methods of President George W. Bush's "faith-based initiative" mode of corruption,

6. As a British wag might say of Vice-President Dick Cheney's war in Iraq, this time, "The Star Spangled Banner went down to the tune of the Strumpet's Red Blair."

which were applied, as by the Emperor Constantine, against a Christianity which the Roman Empire had failed to crush by fascist force.⁷

The Power of Natural Law

Since Solon of Athens, the positive thrust within the history of European civilization, has been toward a system of government under a principle known in the Classical Greek of Plato's *Republic* and the Apostle Paul's *I Corinthians* 13 as *agapē*. The modern English usage in law identifies this as the "general welfare" clause, which is integral to the supreme constitutional law set forth in the Preamble of the U.S. Federal Constitution. This notion of constitutional law, as rooted in *natural law*, is in direct opposition to widespread, contrary notions of the authority of positive law, such as those of "common law."

So, the first modern European nation-states, those of Louis XI's France and Henry VII's England, were of a distinct, new quality termed *commonwealth* societies, in which the highest authority in law is bound to submit to the authority implicit in the natural-law principle of the general welfare of all of the members of that society, including its posterity.

Thus, since Solon of Athens to the present, the essential conflict in principles of law and government within now globally-extended European civilization, has been the conflict between imperial law, as a form of the merely positive law, and the conception of natural law.

So, as historian Graham Lowry brought this into focus, the emerging conflict within England under Queen Anne was that between the notion of the commonwealth, which the Tory circles of Jonathan Swift and Gottfried Leibniz typified, against the Anglo-Dutch Liberal, imperialist faction associated with the brutish William of Orange. In light of the negotiated succession, from Stuart to Hannover, the fate of England under Queen Anne would be decided by which policy would be represented by Anne's successor to the throne. Leibniz was personally at the center of this conflict. George I succeeded, and England went against its loyal nationalists, and so the British, or should we not prefer "brutish," Empire was born.

This development which was secured in the closing moments of the life of Queen Anne, marked a reversal of a

general upward turn in Europe's science and government marked by the interval from the 1648 Treaty of Westphalia through the accession of England's George I, and the plunge of Europe into the hellish cauldron of Eighteenth-Century neo-Venetian Liberalism. This political development became the dividing-line within modern European civilization from that moment to the present day.

It is from that vantage-point that the cultural down-slide of the culture of Europe, from the death of Anne until the rise of the Classical revival around Kästner's protégé Gotthold Lessing and Lessing's friend Moses Mendelssohn, is to be understood. With the latter Classical renaissance spreading from Germany, and the wave of optimism associated with the cause of American freedom from brutish tyranny, a great partial victory for the cause of global civilization based upon the commonwealth principle, was struck. Since those Eighteenth-Century developments, there has been a presently continuing central, global conflict between the opposing causes of national sovereignty and empire, as empire is typified today by the neo-Venetian, Liberal imperialist obscenity called "globalization."

Science and Identity: A Tale of Two Jews

Now, consider a tale of two Jews, the Christian Apostle Peter and his friend Philo of Alexandria, which I have retold several times for its scientific, as well as theological relevance, as the occasion warranted this reference.

Philo is justly famous for, among other accomplishments, his salutary ridicule of those of his time who attempted to bring the dogma of the then long-deceased, and better forgotten reductionist, Aristotle, into play within the domain of theology. The silly Aristoteleans of Philo's time, had adopted the sophistry of their word-play on the use of the term "Perfection," to make the same foolish argument which the most rabid of our sundry contemporary varieties of cults of religious "fundamentalists" chant today, without any of the relatively scholarly elegance of Aristotle's refined sophistry. The significance of Philo's attack on the core of Aristotle's reductionist method for us here, in this discussion, is that Aristotle's error is typical of the prevalent pathological core assumptions of belief in science, politics, religion, and otherwise, among

7. The great ecumenical Council of Florence was the occasion for exposing that hoax of the fraudulent "Donation of Constantine" which had been the pretext employed by the imperial forces of Rome, since Constantine, for attempting to control the Christian churches. Not accidentally, the conduct of the scrutiny of relevant ancient documents in possession of the Byzantine archives was done, as this Council development was presented to a relevant Rome Church body by Helga Zepp-LaRouche, by the same Nicholas of Cusa whose *Concordantia Catholica* served the relevant forces of the Council in launching the first modern, commonwealth form of nation-states, that of Louis XI's France and Henry VII's England, thus superseding a similar intention expressed by Dante Alighieri's *De Monarchia*. This refuted "Donation" was, as Charlemagne had protested, a concocted hoax, but it had dominated Europe, until the Council of Florence, under Venice's grasping the power of its alliance with the Norman chivalry from the decadent Byzantine system. Essentially, the "Donation" hoax was intended to place Christianity, through

imperial control over the bishops, under the management of the pagan Roman Imperial Pantheon. This "Donation of Constantine" hoax served the Venetian-Norman partnership as the imperial legal doctrine of the *ultramontane* form of imperial system. The meaning of the term "imperial system" is a form of government over a collection of subject peoples under whose law all power to make law throughout that realm lies within the personality of either an emperor, or a person or oligarchy functioning in the law-making capacity of an emperor. Under an imperial system, subordinate authorities, such as kings of nations, can not make law, but only make rules within the bounds set by the imperial law-making personality. The Venetian *ultramontane* system's policy was to assign this power of law-making to the Pope, on the condition that the Pope was literally, or virtually owned by the Venetian financier-oligarchy. Popes who displeased the Venetian oligarchy tended to be quickly replaced; this type of paganist corruption of religious bodies was the model for what became known more recently as "the integrist system."



clipart.com

Apostle Peter (died 64 A.D.). An Apostle who lived in the Classical Greek tradition, and friend of Philo of Alexandria.



clipart.com

Philo of Alexandria (20 B.C.-50 A.D.). The Jewish philosopher ridiculed those who sought to bring Aristotle into the realm of theology.

today's globally extended influence of European culture.

The scientific world-view of the Pythagorean tradition knows the universality of sense-phenomena, as existing within the bounds of a universe of those efficient universal physical principles which exist beyond the domain of sense-perceptual objects; whereas, the ignorant man imagines an irrational sort of spiritual universe, one existing outside the reality of universal physical principles, a reality which is known to a competent modern European physical science derived from *Sphaerics*. This is the underlying, theological issue posed by Philo's attack on Aristotle.

For those in the Classical Greek tradition, such as the Apostles John and Paul, or the Apostle Peter's friend, Philo of Alexandria, the spiritual world of immortality is the efficiently existing universe, wherein the human mind may discover the immortal universal principles which are reflected imperfectly, as Paul insists that we see as "through a glass darkly," as we see phenomena within the inferior domain of the mortal human individual's sense-perceptual experience. For competent science, it is the unseen principle which peers at us when it is reflected among the shadows of reality which we perceive as phenomena.

Thus, for the purblind mind, a mind still inclined to seek out the bestial state of experience, it is the completed experience of the perceived phenomenon of sense-certainty which is reality, rather than the actually ruling principles of the universe which generate perceived effects of principles. These principles are the effects which such feeble intellects regard as merely the imperfect, haunting shadows cast by the distant light of a different universe than the one which the mortal individual inhabits. That purblind mind of the feeble intellect, is the commonly characteristic feature of all systematic reductionism, in the practice of physical science, otherwise. Thus, for all dolts of the reductionist persuasions, the word "perfect" signifies "completed." This was, of course, the view of the physical universe as portrayed by

the devotees of pagan superstitions as taught by the Roman hoaxster of astronomy, Claudius Ptolemy.

So, for those Aristoteleans among his contemporaries whose follies were denounced by Philo, the act of universal Creation was a *completed* action, in the sense of being unchangeable. Hence the gnostic's blind reliance on prophecy among such ignorant people. For Claudius Ptolemy's explicitly Aristotelean notion of the universe of that type, if God were Perfect, He could never change the habitual way in which the universe showed itself to man. In contrast, the implied view of Creation in the mind of the Pythagorean, is the universality of a principle of a continuing process of Creation.

In the case of human behavior, the universe of those hypotheses which are validated experimentally as universal principles, the universality of that process of such development is dominated by higher orders of the continuing generation of hypotheses, as V.I. Vernadsky's portrayal of the growth of the Biosphere and Noösphere, relative to the abiotic domain, illustrates the point. The higher hypothesis, that of hypothesizing the higher hypothesis, is, in turn, the subject of a unifying principle of universal creation. This universe, as Albert Einstein, with his notion of a "finite but unbounded universe," approximated a Riemannian conception of a finitely self-bounded universe, is defined ontologically as an existent process of constantly ongoing creation, as defined in these terms of reference.⁸

Look at Philo's objection to Aristotle in terms of the equivalence of the way in which Claudius Ptolemy was to follow the same argument of Aristotle's later. Aristotle's and Ptolemy's is a universe as would have been designed for man by the Olympian Zeus of Aeschylus' *Prometheus Bound*. For Ptolemy as for Aristotle, "perfected" is "completed" in the sense of an unchanging, unchangeably fixed order of events in the universality within which man's experience is situated. Indeed Ptolemy relied on Aristotle's attributed authority on this specific point. No creative innovation, comparable to knowledge of the use of "fire," is permitted to lie in man's willful hands, or, for Aristotle, the Creator's. Hence, the door was left open for Satan, as gnostic, to play.

This is, in its bare-bones version, almost exactly the axiomatic assumption of the mathematical-physical system of the empiricists Hobbes, Descartes, Locke, Mandeville, Quesnay, and the argument of the empiricists D'Alembert,

8. The extent of the finite universe is the reach of its universal principles. The implications of this are made clearer within the bounds of Riemann's grasp of what he termed "Dirichlet's Principle."

Euler, and Lagrange against Kepler, Leibniz, et al. There is no provision in empiricism for a principled kind of change in a pre-fixed system.

So, Aristotle's system requires that once the Creator, were He perfect, had acted perfectly in the act of Creation, He could never change, by His own will, what He had once set into motion. Hence, the fraudulent astronomy of the Roman imperial ideologue Claudius Ptolemy.

As a matter of illustration, consider the typical gnostic religious nut of the U.S.A. today. He avows that "God has predetermined 'the coming of the end days' " to some definite date allegedly built into some "Biblical prophecy." God is not permitted to make up His own mind, and, perhaps, change that date! "Neither man, nor God will ever be permitted to change anything from a predetermined, fixed order of things" in what religious fanatics prescribe as the rectilinear universe. "Please

Zeus! Neither God nor man's free will can change anything to alter the predetermined order of things."

Philo objected, as do I.

The issue which I have just outlined here, is almost the same as that argument made by the empiricists D'Alembert, Euler, Lagrange, et al. against Leibniz—*almost*.

Enter, Paolo Sarpi

From Diocletian until the Fifteenth-Century European Renaissance, the prevalent imperial orders in Europe prescribed a relatively fixed order of affairs in the life of the ordinary persons, an order in which the ruling social strata, imitating the gods of Olympus, played their capricious pranks on the masses of a subject people who were assigned to maintain an essential monotony in the form of their life-long practice.

That was changed in a radical way by the great reforms of

Box 9

What Galileo Avoided

In 1609, Kepler published the *New Astronomy*, a revolutionary work that for the first time used celestial physics as the basis for the ordering of the Solar System. Up to this point, since the hoax of Ptolemy's geocentric model, all astronomy was based on the Aristotelian idea that cause (i.e., Truth) was unknowable. The only thing that could be attained, according to Aristotle, at best was "mathematical" approximations of what you see. This is what later became known as empiricism.

This "mathematical" idea of a universe in which there is no truth, best suits the oligarchy. Everyone must know his or her place, and change is impossible.

Kepler's work was a revolution in the way mankind relates to the universe, determining the way in which man acts, which the oligarchy feared the most. Kepler was a thinker in the tradition of Plato, and makes clear the self-conscious process he went through to make his discoveries. Contrary to Aristotle's method, he uses the method of Plato, by looking with the mind, to the discovery of true cause, behind the shadows of sense perception. He doesn't give you a five-page book with bullet points and mathematical formulas of the finished product; he takes you through every subjective step

of his discovery. In doing this, he develops the Principle of Universal Gravitation, as an Idea. No one has ever "seen" the Solar System, not even our astronauts. It is through a subjective creative process that one develops a "picture" in the mind, of what is really going on out there. This is the basis of science and being human. This also determines the way mankind relates to nature and each other. Because Kepler's discoveries were a revolution in science, the oligarchy promoted the money-hungry opportunist Galileo Galilei, who cared nothing for the truth.

In 1596, Kepler published the first of his great works, the *Mysterium Cosmographicum*, where he makes his first breakthrough in making a Platonic hypothesis based on the physical causes determining the ordering of the Solar System. In a very enthusiastic and human way, Kepler sends out copies to all of his peers, as well as Galileo. In 1597, Galileo finally responded in a letter:

Galileo to Kepler:

"Like you, I accepted the Copernican position several years ago and discovered from thence the causes of many natural effects which are doubtless inexplicable

by the current theories. I have written up many of my reasons and refutations on the subject, but I have not dared until now to bring them into the open, being warned by the fortunes of Copernicus himself, our master, who procured immortal fame among a few, but stepped down among the great crowd (for the foolish are numerous), only to be derided and dishonored. I would dare publish my thoughts if there were many like you; but, since there are not, I shall forebear."

Kepler to Galileo:

"I could only have wished that you, who have so profound an insight, would choose another way. You advise us, by your personal example, and in discreetly veiled fashion, to retreat before the general ignorance and not to expose ourselves or heedlessly to oppose the violent attacks of the mob of scholars (and in this, you follow Plato and Pythagoras, our true masters). But after a tremendous task has been begun in our time, first by Copernicus, and then by many very learned mathematicians, and when the assertion that the Earth moves can no longer be considered something new, would it not be much better to pull the wagon to its goal by our joint efforts, now that we have got it under way, and gradually, with powerful voices, to shout down the common herd, which really does not weigh the arguments very carefully? Thus, perhaps by cleverness, we may

Europe's Fifteenth-Century Renaissance. Brunelleschi and Nicholas of Cusa, and such among his avowed followers as Luca Pacioli and Leonardo da Vinci, in the unleashing of modern experimental physical science, changed history radically. Despite the efforts of a resurgent Venice to suppress the development of science and the nation-state by means of the religious warfare of 1492-1648, progress led by France and England unleashed an unstoppable flourishing of scientific, technological, and related economic and social progress.

In this setting, where the military and related potentials of national cultures and their factions must adapt to the increase in military and related power introduced by the combination of scientific progress and the upgrading of the intellectual and moral quality of the general population, the old faction of Venice was gradually forced to make way for the rising new faction led by Paolo Sarpi, the founder of empiricism. Sarpi's

faction was as opposed to the science of the Pythagoreans, Plato, Cusa, Leonardo da Vinci, and Kepler as the old faction of the Venetian oligarchy, but Sarpi was not prepared to be so stubbornly opposed to the products of science, as to lose the wars thereby.

So, the military-strategic and related changes in the order of modern military and related affairs persuaded Sarpi's new party of Venice to loosen the barriers to acceptance of some degree of scientific-technological progress. Sarpi house-lackey Galileo's awkward plagiarizing of the work of Kepler, on the issue of the motion of the planets about the Sun, was typical of the new spirit of empiricism unleashed by Sarpi's revival of the precedents of the medieval William of Ockham. In effect, in Sarpi's bedroom, the Olympian Zeus unbuttoned himself. (See **Box 9**.)

Thus, under empiricism, change was tolerated within lim-

bring it to a knowledge of the truth. With your arguments you would at the same time help your comrades who endure so many unjust judgments, for they would obtain either comfort from your agreement or protection from your influential position. It is not only your Italians who cannot believe that they move if they do not feel it, but we in Germany also do not, by any means, endear ourselves with this idea. Yet there are ways by which we protect ourselves against these difficulties."

He continues: "Be of good cheer, Galileo, and come out publicly. If I judge correctly, there are only a few of the distinguished mathematicians of Europe who would part company with us, so great is the power of truth. If Italy seems a less favorable place for your publication, and if you look for difficulties there, perhaps Germany will allow us this freedom."

Here it is clear that Kepler sees some good in Galileo, but Galileo is more concerned with himself and his own personal gain, rather than lifting the veil of ignorance off the minds of his fellow human being.

In 1609, Kepler a copy of his *New Astronomy* to Galileo, wanting to know what he thought of it; Galileo didn't reply. That same year, under the benefaction of Paolo Sarpi, Galileo was brought to demonstrate the telescope (a rare device at the time) to the government of Venice. His pay was greatly increased for doing this, and Paolo Sarpi heavily promoted his work, under the Venetian oligarchy.

This was done in reaction to Kepler's scientific revolution, to keep mankind from discovering the method of Plato.

Typical of his method, Galileo based his later work on observations made with a telescope, not by looking for causes (you can't do it with just your eyes), but for a way to explain what he saw.

In 1632, Galileo published *A Dialogue Concerning the Two Chief World Systems*, where he attempts to argue against the already discredited Aristotle; instead he actually *revives* the method of Aristotle by arguing against Kepler, in saying that one cannot know the true causes. In the opening section he states:

"To this end I have taken the Copernican side in the discourse, proceeding as with a pure mathematical hypothesis and striving by every artifice to represent it as superior to supposing the Earth motionless, not, indeed absolutely, but as against the arguments of some professed Peripatetics."

He goes on: "First, I shall try to show that all experiments practicable upon the Earth are insufficient measures for proving its mobility, since they are indifferently adaptable to an Earth in motion or at rest. I hope in so doing to reveal many observations unknown to the ancients. Secondly, the celestial phenomena will be examined, strengthening the Copernican hypothesis until it might seem that this must triumph absolutely. . . . In the third place, I shall propose an ingenious specu-

lation. It happens that long ago I said that the unsolved problem of the ocean tides might receive some light from assuming the motion of the Earth. . . ."

This dialogue clearly came years after Kepler had made his discoveries. Galileo's use of the motion of the tides as his "proof" that the Earth moves, is sophistry. Galileo states that three different forces can move water in a vase; one, when you blow on the water; two, when you place something in the water; and three, when you move the vase itself, and therefore the tides move because the Earth moves. He spends a fourth of the dialogue working through his "proof," even though Kepler had already made clear ten years prior to this "proof," that the tides come from the relationship of the gravitational pull of the Moon and the Sun.

So why is Galileo held to be the father of modern science? When everything he stated was false, and when Kepler clearly, on record, used a method which made breakthroughs in science, that are still in use today, long before Galileo published anything? It's clear that if you have a method to know true history, you will understand. The policy of the oligarchic model of empire is to prevent true discovery, and if discoveries are made, move to destroy the method, and then, the individual who produced those discoveries. Galileo may have let the Earth move, but he avoided the universal principle, which that motion expressed.

—Chris Landry

its, but the principles of science were not to be shared with the underlying mass of the population. A modified Aristoteleanism, Ockham-style, was adopted, based on the model of a Euclidean form of Aristotelean doctrine. This was known as empiricism, a name which was interchangeable with what became Anglo-Dutch Liberalism. In the resulting combat between the reborn Pythagorean-Platonic tradition in science, and the opposing empiricists, the issue of the Delian paradox came to the fore as the leading edge of the empiricists' combat against the influence of Leibniz.

In the history of European civilization since the time of Classical Greece, the principal division among categories of factions has been, as Friedrich Schiller crafted this view, the conflict between the principle of natural law of Solon of Athens, and the oligarchical principle which the Delphi cult had introduced as the code of Lycurgus' Sparta. In the time of Plato's faction in Athens, the oligarchical faction was also known as "the Persian model," or heritage of the Babylonian priesthood which still controlled the Persian Empire from inside. Schiller's formulation thus defines, still today, the entire sweep of globally extended European history from the time of the Pythagoreans, and earlier, to the present moment. The oligarchical models included the Achaemenid Empire; the ambitions of such enemies of Alexander the Great as his father, King Philip of Macedon, and Aristotle; the Roman Empire; the Byzantine Empire; the *ultramontane* imperialism of Crusading Venice and its partner the Norman chivalry; and the Anglo-Dutch Liberal system which is entirely an outgrowth of the programmatic approach of Venice's Paolo Sarpi.

Put the intention of Sarpi inside a more up-to-date version of the Olympian Zeus of Aeschylus' drama.

How could that better-informed Zeus control the mass of humanity as virtually mere cattle, while adapting to the immediately unavoidable reality of the unleashing of the general population for participation in technological progress? The way in which Sarpi's crew, including, notably, Sarpi's house-lackey Galileo, reacted against the mammoth outpouring of scientific creativity produced by the Kepler who was the faithful and prolific follower of Nicholas of Cusa and Leonardo da Vinci.

Sarpi kept the essential intention of Aristotle's system, but cut a small chink in the system, to permit some unavoidable adaptations to scientific and related progress to leak through. In this respect, Sarpi, by resurrecting the dogma of William of Ockham, corrected Aristotle by returning directly to the original sophistry of the Delphi Apollo cult. Technological progress must sometimes be permitted, under the stipulated restriction, that the principles of discovery of universal physical and related principles were either simply suppressed, as in the mammoth effort to suppress most of the work of Kepler, or buried in superstition, as the followers of Descartes, Conti, Conti's synthetic Newton, and Voltaire, prescribed.

Inevitably, as the Platonic Academy's Eratosthenes fore-

saw, Archytas' construction of the solution for the Delian paradox became the pivotal feature of the greatest controversies, such as the Descartes-Leibniz division, in the modern practice of science, culture, and statecraft. The continuing conflict since 1763, between the emerging American System of political-economy, and that British Empire more precisely described as the imperial expression of the Venetian financier-oligarchical system as the Anglo-Dutch Liberal system of globalization today, is the pivot of ongoing world history, still today. It is still, today, the ongoing conflict between the heirs of Paolo Sarpi and the role of Gottfried Leibniz. What is new in this conflict, is that we have reached the threshold at which, finally, one of the two combatants must lose absolutely, with the qualification, that if the Leibniz legacy loses, all mankind would be plunged into a global new dark age.

That setting now provided, consider the significance of the issue of Gauss's 1799 doctoral dissertation accordingly.

2. Gauss's Power

Gottfried Leibniz's exposure of the intrinsic incompetence of René Descartes' sterile, mechanistic approach to physical science, and, also, Leibniz's founding of economics as a science (the science of physical economy on which the American System of political-economy was premised), were centered on Leibniz's premising all competent scientific practice on the specific notion of *power* which he traced to the Pythagorean concept of *dynamis*, which he defined as the modern term *dynamics*.

This notion of *power* and *dynamics*, as defined for modern science by Leibniz's exposure of the incompetence of Descartes, was not only the issue underlying Carl F. Gauss's attacks on the reductionists in his 1799 doctoral dissertation; it was the pivotal issue of all leading controversies in Nineteenth-Century and later science.

This pathway in Leibniz's development of the foundations of a general form of modern physical science, which was built upon the platform provided by the combined work of, chiefly, Kepler and Fermat, had several implications which are most notable at this point in our report; but, all of these are pivoted on that concept of *power* which Leibniz brought forward from the legacy left by the Pythagoreans and Plato.

The relevant historical fact must be kept in view, that as Leibniz's development of a science of physical economy is traced over the interval from 1671 to the close of his life, his discovery of the existence of this branch of physical science, as a branch of physical science, was unique. The unique principle at the center and foundation of this discovery in physical science, was identical with Leibniz's attacks on the broader expression of the pervasive incompetence of Descartes' notion of physical science. It was also rooted in Leibniz's uniquely original founding of the calculus, as presented to a Paris print-

er in 1676, a branch of science which, together with the mastery of the implications of elliptical functions, had previously been assigned to future mathematicians by Kepler. The roots of Kepler's prescription had been the implications of the method which he had proven conclusively by the characteris-

tic, internal features of his own absolute originality in his discovery of universal gravitation. (See **Box 10**.)

The general, relatively widespread knowledge of Kepler's discovery of universal gravitation among readers in England, had been made available prior to the misleading bowdleriza-

Box 10

Kepler's Approach

"Anyone who shows me my error and points the way will be for me the great Apollonius."

—Johannes Kepler,
Astronomia Nova

Kepler's anti-Euclidean approach to astrophysics dealt not with the motions of the heavenly bodies, but with the power that caused their motion. Shapes, figures, forms, and curves—none of these were adequate to express a principle that caused motion. Kepler dispenses with the empiricist approach of Ptolemy, Copernicus, and Brahe in the first section of his *Astronomia Nova*, demonstrating that while their three systems appear to differ, they are all geometrically equivalent, and therefore, all wrong. For how can figure cause itself?

Kepler's adoption of *metaphor*, in his revival of the Greek approach of *Sphaerics*, called for something that is not a shape, curve, figure, or any other geometric object expressed in sense-perceptual terms: *gravitation*. In developing his hypothesis of universal gravitation and his working-through of the operation of this idea ("species"), he lawfully pushed the inadequate geometric language of his time past its limits to the point of collapse:

Kepler hypothesized that planets move in

ellipses at a speed inversely proportional to their distance from the Sun due to the weakened power of gravitation at greater distances (**Figure 1**).

A problem arises in implementing this idea: Since a planet's direction changes at every moment, how small must these triangles be, and how many are needed to be a perfectly accurate measure of time? If the triangle has any size at all, does it not presuppose linear action in the small, and eliminate constant change? Kepler transforms the idea of an infinite number of triangles of

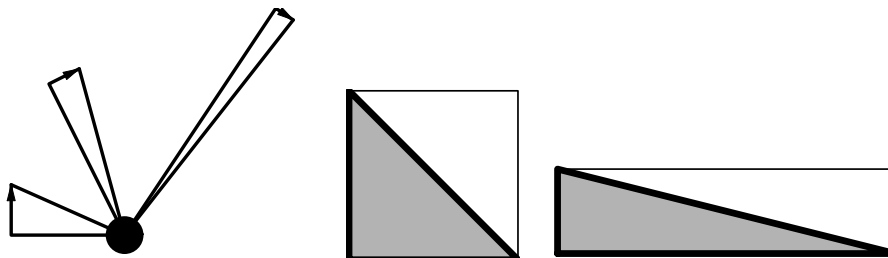
motion, each seemingly so small as to be "nothing," into a continuous area swept out between the planet and the Sun, which idea Kepler uses as a measure of time (**Figure 2**).

Here, planet *P* has moved a distance of arc *A* from point *O*, sweeping out an area *SPO*, which area is a measure for the time of the motion. This area consists of both a circular sector *CPO* and a triangle *SCP*. While the area of circular section *CPO* is measured by the length of arc *A*, the area of triangle *SCP* is measured by *h*, the *sine* of arc *A*.

As Cusa had demonstrated over a century earlier, these two magnitudes, *A* and *h*, are incommensurable. Given a position *P*, it is possible to measure and determine the enclosed area, but, given a

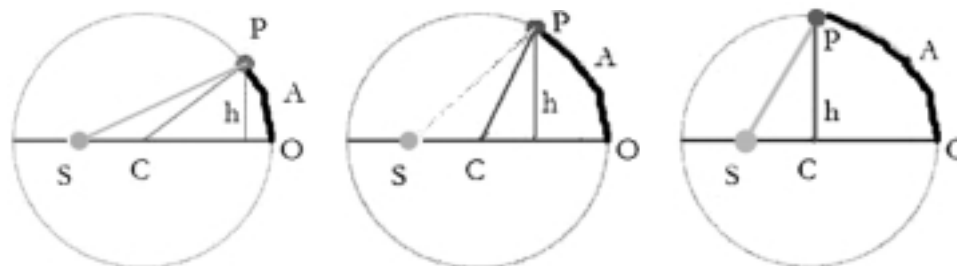
Box 10 continues on next page

FIGURE 1



The distance a planet moves in a period of time is inversely proportional to its distance from the Sun. The same given interval of time results in triangles of equal area. For example, at a distance (radius) twice as far from the Sun, the motion per time interval (arrowed change) is only half as far. This makes a triangle of double length but only half the height, which is therefore the same area. This area is a measure for time.

FIGURE 2



tion of Kepler’s work by, ostensibly, Isaac Newton. To the extent of the relevant biographical evidence available, to the end of his life, Newton had no relevant knowledge of what a calculus is to the end of his life.

To situate the subject of the implied attacks, by D’Alembert, Euler, Lagrange, et al., against the physical relevance of Archytas’ solution not only for the Delian paradox, but that paradox’s relevance for all competent modern science and statecraft,

desired area, is it possible to exactly determine P ? Kepler found this task of determining the *exact* position of a planet at a future time to be impossible:

“And while the former [circular sector] is numbered by the arc of the eccentric, the latter [triangle] is numbered by the sine of that arc. . . . And the ratios between the arcs and their sines are infinite in number. So, when we begin with the sum of the two [the sought area as a measure for time], we cannot say how great the arc is, and how great its sine, corresponding to this sum. . . . I exhort the geometers to solve me this problem: ‘Given the area of a part of a semicircle and a point on the diameter, to find the arc and the angle at that point, the sides of which angle and which arc, enclose the given area.’. . . It is enough for me to believe that I could not solve this a priori, owing to the heterogeneity of the arc to the sine. Anyone who shows me my error and points the way will be for me the great Apollonius.”

The “error” lies not with Kepler, but with the underdeveloped language he was

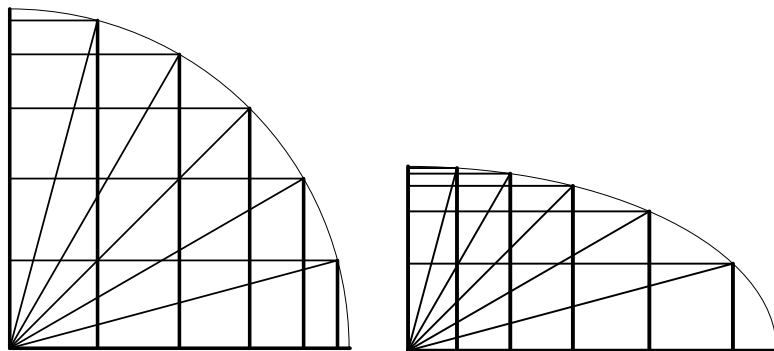
using. He had developed a physical principle that lay between the “cracks” of geometry, but his mathematical language was one of figures, not principles. The cracks between his triangles were mathematical anomalies, but reflected an ever-present physical cause. It remained for Leibniz to introduce *metaphor (dynamics)* to create a physical mathematics adequate to address *physical*, rather than merely *mathematical* questions.

Kepler’s challenge to the future prompted Leibniz’s mastering of “nothings,” such as the cracks between Kepler’s area triangles, in his uniquely original discovery of a truly infinitesimal calculus (**Figure 3**).

Leibniz’s calculus was not enough. The double incommensurability of the ellipse defied Leibniz’s attempts at expression by circular functions. A fuller understanding of the higher classes of elliptical and hyper-elliptical transcendental functions would have to await the work of Gauss, Abel, and Riemann, over two centuries after Kepler.

—Jason Ross

FIGURE 3



Circular and elliptical quadrants. The length of arc along a circle is directly measured by the angle of rotation from the center; while the lengths of the sines (vertical lines) change unmeasurably. On the ellipse, the incommensurability of the sine continues to exist, as well as another: The length of arc is no longer measurable by the angle of (circular) rotation at the center. (Is it fair to even consider rotation on an ellipse from the standpoint of constant circular rotation?) Can a magnitude be doubly incommensurable? If so, what is creating it, for how could an already understood principle create something incomprehensible?

the highlights on this subject from Leibniz's work and its modern background must be brought into focus. (See **Box 11**.)

All competent forms of modern European science are outgrowths of the revolutionary revival of ancient Platonic sci-

ence, from Pythagoras through Eratosthenes and Archimedes, by Cardinal Nicholas of Cusa.

Cusa's crucial discoveries on this account are embedded, in some significant part, among his sermons, but are otherwise

Box 11

Leibniz vs. Descartes

Following in the footsteps of the heroic accomplishments of Kepler, who poetically described the motion of the planets as "at once so well hidden and so admirable," the ongoing scientific debate of the 17th Century became centered around the elusive concept of motion, and the true science necessary to comprehend such physical change.

As Leibniz was elaborating the discoveries of Kepler with his discovery of the Infinitesimal Calculus, his disgust with the state of scientific method in his day prompted him to a polemical response:

"When I consider that practice does not profit from the light of theory, that we do not strive to lessen the number of disputes but to augment them, that we are content with specious argumentation instead of a serious and conclusive method, I fear we shall remain for a long time in our present confusion and indigence through our own fault. I even fear that after uselessly exhausting curiosity without obtaining from our investigations any considerable gain for our happiness, people may be disgusted with the sciences, and that a fatal despair may cause them to fall back into barbarism."—From the *Precepts for Advancing the Sciences and Arts*, 1680

Coming out of his experience at Colbert's Academy of Sciences in Paris from 1672-76, Leibniz was confronted with the fact that even the best of minds were not immune to the popular materialist dogma infecting the population.

In the *Discourse on Metaphysics*, written in 1686, Leibniz, echoing the Socrates of Plato's *Phaedo*, distinguishes between the popular method of the

day and his own:

"As if in order to account for the capture of an important place by a prince, the historian should say it was because the particles of powder in the cannon, having been touched by a spark of fire, expanded with a rapidity capable of pushing a hard solid body against the walls of the place, while the little particles which composed the brass of the cannon were so well interlaced that they did not separate under this impact—as if he should account for it in this way instead of making us see how the foresight of the conqueror brought him to choose the time and the proper means and how his ability surmounted all obstacles."

Leibniz had no trouble, however, locating the principal figure responsible for spreading this type of thinking throughout the population: He was the popularly celebrated Descartes.

Incapable of Discovery

In a letter to Molanus from 1679, Leibniz frankly states his posture on the Cartesians:

"I have recognized from experience that those who are completely Cartesian are not capable of discovery; there have been many beautiful discoveries since Descartes, but, as far as I know, not one of them has come from a true Cartesian. Descartes himself had a rather limited mind. He excelled all people in speculation, but he discovered nothing useful in the practice of the arts."

The fraud of Descartes, coupled with a susceptibility to such contagions among the people on the Continent, provided Leibniz sufficient reason to center

his early work on annihilating such disease. Hence, Leibniz would embark on a strategic refutation of Descartes and his philosophy, preventing Europe from returning to the previous age of religious war.

Descartes' popularity, largely dependent on a cult following, developed mostly from his method of analytical investigations rather than from scientific advancement. According to Descartes, "The nature of matter or of body in its universal aspect, does not consist in its being hard, or heavy, or colored, or one that affects our senses in some other way, but solely in the fact that it is a substance extended in length, breadth, and depth." A method falsely known as *mechanics*, his philosophy relegates the physical universe to empirical observations, geometric descriptions, and mathematical rules. But is this not a sufficient course of inquiry to understand the nature of objects and events?

Think back to the problems which confronted our youthful star-gazing ancestors. Follow the motions of the planets (from the Greek, for "wanderers") they observed at night. Take the famous case of Mars, or Ares to the Greeks. That a capricious and violent-natured Greek god of war would share that name has never been coincidence. Could one successfully express the future motions and oppositions of the planet merely from the previously observed whimsical behavior of the planet? Could one extrapolate the destiny of the planet based on a geometrical description of its changing angular velocities and directions upon our Celestial Sphere?

The materialist fool would assent! Thus, Kepler attacked Ptolemy for similar blunders.

Thus, Leibniz exposes the fraud of Descartes:

Box 11 continues on next page

associated in a series of his relevant writings which began with his ground-breaking statement of the principles of modern experimental physical science in his *De Docta Ignorantia*. From a Cusa working in the same environment as the cele-

brated, and literally towering employer of the catenary principle for construction, Filippo Brunelleschi, the development of the principal valid currents of modern physical science, runs through, most notably, Luca Pacioli, Leonardo da Vinci,

“... [O]ver and above that which is deduced from extension and its variation or modification alone, we must add and recognize in bodies certain notions or forms that are immaterial, so to speak, or independent of extension, which you can call powers [*potentia*], by means of which speed is adjusted to magnitude. These powers consist not in motion, indeed, not ... the beginning of motion, but in that intrinsic reason for motion. ... From this we shall also show that it is not the same quantity of motion (which misleads many), but the same powers that are conserved in the world.”—*The Nature of Bodies and the Laws of Motion*

Laws of Motion

To begin an investigation of such ontological problems, ask yourself this question: Does an object of one pound, travelling with a velocity of four feet/second, have the same applied effect as a four-pound object travelling with a velocity of one foot/second? Consider various examples.

Descartes measures such potential for affecting change for any moving object as mass \times velocity, or mv , calling this mv the object's “quantity of motion.” That is, the power of a moving object to affect a change is a composite of the object's empirical quantities of mass and velocity. Applying this to the two objects above, both objects would be equivalent in applied effect. But is this the case? Just like the planets, are its future effects caused by the effects that had been exhibited before?

Now, go back to our two objects, the first of one pound, and the other of four pounds. How many times must you lift the one-pound object to have lifted the same amount, if you only lifted the four-pound object once? Easy, right?

If you had to carry five gallons of water, you could carry that weight all at once, or take five separate trips. Either way, the amount of effort you exert in car-

rying the water will be the same. Therefore, lifting a one-pound object four feet, and a four-pound object one foot, is also the same. We can say the effect is equal.

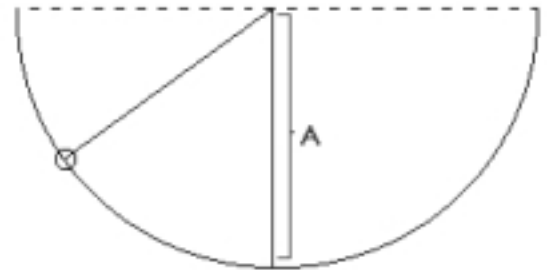
Now travel back to the 17th Century, when physicists began concentrating on the pendulum as a unique form of action. What happens when you raise the pendulum and let it drop? How far up does the pendulum ball swing? Create your own pendulum and experiment before going on. (**Figure 1**)

If we neglect air resistance and other perturbing factors, the pendulum ball will swing back to its original height. This would mean that the velocity of a pendulum at the bottom of its swing is capable of bringing the pendulum back to its original height.

Applying this to our one-pound and four-pound objects, if we hung the first on a pendulum with an amplitude of four feet and the second on a pendulum with an amplitude of one foot, at the bottom of their swings, the first would have acquired the ability to lift a one-pound body four feet, and the second, an ability to lift a four-pound body one foot. We just found from before, however, that those two abilities were equal, right?

Well, if Descartes' “quantity of motion” argument holds true, a one-pound object dropped from a height of four feet would be travelling four times faster when it hits the ground than a four-pound object dropped from a height of one foot. Would this be the case? Think about how things fall. Work it out for yourself. How would you test this hypothesis? Do some physical experiments. What about the time it takes for each to descend?

FIGURE 1



Circular pendulum.

‘Living Force’

Leibniz contrasts Descartes' quantity of motion with his *vis viva*, or living force. As he says in his *Specimen Dynamicum*:

“I concluded that besides purely mathematical principles subject to the imagination, there must be admitted certain metaphysical principles perceptible only by the mind, and that a certain higher, and so to speak, formal principle must be added to that of material mass, since all the truths about corporeal things cannot be derived from logical and geometrical axioms alone, namely, those of great and small, whole and part, figure and situation—but that there must be added those of cause and effect, action and passion, in order to give a reasonable account of the order of things.”

If you've done some successful physical experiments, you can grasp what Leibniz determined: that a moving object's ability to effect change is determined not by mv , but by a “higher notion” outside the realm of our sense perceptions, proportional to the mass \times the square of the velocity, or mv^2 .

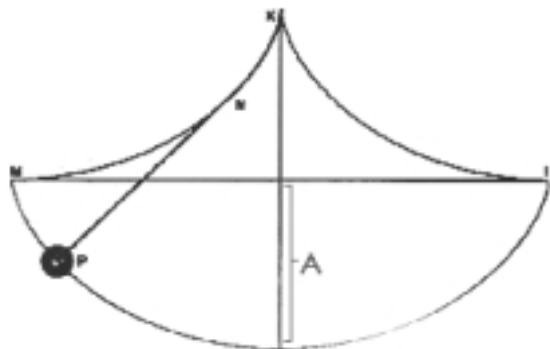
Consider another example. Does a car of 2,000 pounds moving at 1 mph have the same impact as an object of one pound moving at 2,000 mph? What about when they hit you? Using Descartes' “quantity of motion,” they would be the same.

Johannes Kepler, Fermat, Pascal, Huyghens, and Leibniz, through the revival of Leibniz by such outstanding figures of France's École Polytechnique as Gaspard Monge and Lazare Carnot and their anti-Lagrangian co-thinkers, and the protégés

of the École Polytechnique's leading German member, and Lazare Carnot associate, Alexander von Humboldt.

With the seed of ruin of France's leading position in world science under Napoleon Bonaparte's choice of Euler's protégé

FIGURE 2



Cycloidal pendulum.

Using Leibniz's metaphysical metric the object then has a force 2,000 times the force of the car!

Just in case one might mistake Leibniz's attack as a mere academic dispute, he intervenes: "These considerations are not worthless, nor are they merely verbal, for they have important applications in the comparison of machines and motions. For if enough force is received, from water power, animals, or some other cause [steam!], to keep a heavy body of 100 pounds in constant motion, so that it can complete a horizontal circle 30 feet in diameter in a fourth of a minute, and someone claims that a weight twice as large put in its place would complete half the circle in the same time, and with less expenditure of power, and claims this means a profit to you, you may know that you are being deceived and are losing half of the force."

Science of Dynamics

So, what is Leibniz's method?

Surpassing the contemplation of momentary motion, or perceived change of place of any object, which is less easily apprehended than one may commonly think—like the Sun moving across the sky—Leibniz directs his attention toward the "cause of these changes" as "something more real," searching for the unseen

powers which generate such change.

As he says in the *Discourse on Metaphysics*:

"We can see therefore how the force ought to be estimated by the quantity of the effect which it is able to produce, for example by the height to which a body of certain weight can be raised." So it is, that Leibniz has determined the *potential* to accomplish work, or in this case the ability to raise an object a certain height, as the necessary measurement of physical action.

Leibniz continues in his *Preliminary Specimen* (1691):

"When I discovered these things, I judged that it was worth the trouble to muster the force of my reasonings through demonstrations of the greatest evidence, so that, little by little, I might lay the foundations for the *true elements of the new science of power and action*, which one might call *dynamics*."

To further grasp Leibniz's conception of *dynamics*, the reader should consider the following problem.

Given a simple circular pendulum and a cycloidal pendulum—Huyghens' tautochrone—both of the same amplitude *A*, what is the difference in *power* between the two? (Figure 2)

Although the reductionist physicist might argue that each has the same "kinetic energy" (i.e., mv^2) at the bottom of their oscillation, there hides within the dynamic a *power* whose effects are not expressed in the abiotic domain.

Reconsider the problem from the standpoint of a physical economist. What is the effect of the two, situated within a human economy (e.g., the 17th-Century economy)?

—MyHoa Steger, Michael Steger, and Merv Fansler

Lagrange, and the continuation of that influence in the ruinous reform of the *École* by Laplace and the neo-Cartesian Cauchy, world leadership in science shifted, together with von Humboldt's protégé Lejeune Dirichlet, from France into Germany.

It was in this setting, that the Gauss who would be singled out, soon after, for special persecution by Napoleon's regime, wrote and published his 1799 doctoral dissertation exposing the fraud of the attacks by D'Alembert, Euler, Lagrange, et al. on Leibniz. Although the attacks on Gauss by Napoleon's regime occurred as part of Napoleon's attacks on certain leading circles of German science at what had been Abraham Kästner's Göttingen University, the attack on Gauss was more severe, and of special significance, apart from the incompetent attempted rebuttal of Gauss's dissertation by Napoleon's protégé Lagrange.

Gauss was rescued from this attack by the *École* circles of Carnot and Alexander von Humboldt, to continue to play his already leading role, from Germany, in world science. However, the continuing destruction of Jacobin and Napoleonic France's earlier leading role in world science, from 1789 and beyond, was continued by the British Duke of Wellington, who was the relevant Vienna Congress's occupation authority, who, in turn, placed Britain's tamed legitimist puppet-monarch on the restored throne of France, a monarch who then placed Lagrange followers Laplace and Cauchy in charge of the systematic ruin of the *École Polytechnique*.

After this experience, and now in a post-1813 Germany under the overreaching power represented by Bentham, Metternich, and Palmerston, in a Germany which had been, and remained largely under, successively, French and British thumbs, Gauss was more cautious about raising the crucial issues of physical geometry than he had been in the 1799 publication of his doctoral dissertation. Gauss's later correspondence with János and Farkas Bolyai, and others, makes the suppressed issue of anti-Euclidean geometry clear enough for the witting. In this circumstance, the fuller implications of Gauss's own achievements would not come to the surface until the work of Dirichlet and Riemann. Apart from the crucial contributions made by successive waves of significant progress in discovered principles of experimental physical science, there has been very little honest, net *epistemological* progress in the systemic foundations of mathematical physics world-wide, since the death of Riemann.

In this connection, it is essential to recognize that Laplace and Cauchy were a direct continuation, in every respect, of the D'Alembert, Euler, Lagrange, et al., who were the subject of



Leonhard Euler (1707-1783). An enemy of Leibniz, the Swiss mathematician hysterically dismissed what he could not understand, as "imaginary."



*Augustin Cauchy (1789-1857). This neo-Cartesian mathematician oversaw the destruction of France's *École Polytechnique*, which had been at the vanguard of world science.*

the attack in Gauss's 1799 doctoral dissertation. It is important to take into account that the successors of Laplace, Cauchy et al. include the thermodynamics school of Clausius, Grassmann, and Kelvin, as also Helmholtz and Faraday, who only typify the leading effort to defame the work of Gauss, Wilhelm Weber, Dirichlet, and Riemann, efforts which are continued today, in the shift into a positivist form of extrapolation from the precedents of the earlier leading reductionists D'Alembert, Euler, Lagrange, Laplace, and Cauchy.

The Political Roots of That Attack

This ironical state of affairs should not surprise any thoughtful person who takes into account the fact that the preponderance of power over economic practice in globally extended European civilization since the accession of Britain's George I, has been largely concentrated in a London-centered, global monetary-financial faction whose combined power continues to strike terror into even leading governments still today. The relative hegemony has been maintained in the interest of "The New Venetian Party" represented by the Anglo-Dutch Liberal system of financier-oligarchy's hegemony over most of the traffic which that financier oligarchy's usual monetary-financial system has controlled, top-down, during most of modern history of the period since 1763-1789.

The only significant and durable exception to that global hegemony of the Liberals, has been during some periods of that U.S. conditional supremacy during the last century, such as the Presidency of Franklin Roosevelt and his launching of the Bretton Woods system, for which the European and Wall Street financier oligarchies have never forgiven Roosevelt, or



Lazare Carnot (1753-1823). France's "Organizer of Victory" and leader of the *École Polytechnique*, he based his policy upon the educational and scientific-technological development of the citizenry.



Lejeune Dirichlet (1805-1859). His work brought to fruition the earlier achievements of Gauss, and was in turn used by Riemann to hone the epistemological basis for mathematical physics.

posals of attacks on these challenges which arose from Kepler's own uniquely original discovery of universal gravitation. As distinct from viciously lunatic innovations such as those of Ernst Mach, Bertrand Russell, and their devotees, no actually fundamental, axiomatic advance in the subsuming, essential mathematical principles of physical science has been reported in the open literature, since the elaboration, as by Gauss, Dirichlet, Riemann, and their collaborators, of the implications of Leibniz's discovery of the role of the catenary function in defining natural logarithms and as expressed by Leibniz's *universal physical principle of universal least action*. It was this legacy, chiefly mediated through the work of Leibniz, which has provided the foundation for valid modern science since Leibniz's death, and provided me the indispensable foundations for my original, supplementary contributions to the field of Leibniz's original creation of

my own, subsequent advocacy of that tradition, to the present day. Sometimes, technological innovations have been tolerated under the Anglo-Dutch Liberal system, or even temporarily desired in anticipation of warfare; but the "danger" to the financier-oligarchical interest which the legacy of the Pythagorean conception of science represents, is never tolerated more than reluctantly in customary practice of the Venetian tradition in international monetary-financial affairs.

Contrary to all childish rumors, excepting moments such as those under U.S. President Franklin Roosevelt, it is Venetian financier-oligarchical traditions which reign over the world's and nations' financial-monetary systems to the present day. The situation is not hopeless, but it is more than a little perilous, and requiring more courage to resist such tyranny than most pride-filled leaders of the potential opposition have shown in recent decades. This situation continued, since approximately the 1970s, until the recent shift back toward an "FDR" tradition within the U.S.A., since the Summer and Autumn of 2004, and, more emphatically, January of the present year 2005.

For such politically motivated reasons, all of the valid, or even relatively valid, principal contributions of Nineteenth-Century science, looked back for needed inspiration to the work of Gottfried Leibniz, and from there, to Leibniz's own modern predecessors, from Cusa through Kepler, Fermat, Pascal, and Huyghens, and, in turn, back to the *Sphaerics* of the Pythagoreans and associates of the circles of Plato.

For example, as I have already noted here, the birth of the calculus, as it was originally developed only by Leibniz, and the development of the implications of elliptical functions, as by Gauss and Riemann most emphatically, date from Kepler's pro-

the science of physical economy.

As I have already stressed in the preceding chapter of this report, the issues of mathematics as such which have been the motive for the reductionists' targetting of the legacy of Cusa, Kepler, Leibniz, et al., have always been essentially political, rather than motives of physical science as such. These issues are associated most immediately with the same policies of political-economy which are at issue in the fight to prevent the obliteration of the roots of the former industrial power of the U.S.A. as the same international financier oligarchy has already virtually obliterated the former physical economic potential of what are called "The British Isles."

The same issue, the shift of the world economy toward globalization, was the stated intention of the Bertrand Russell and H.G. Wells who sponsored H.G. Wells' manifesto, his lunatic piece of sophistry, the 1928 *The Open Conspiracy*, which, coupled with the perversions of such Russell devotees as the Norbert Wiener of "information theory" lunacy and John von Neumann of economic and "artificial intelligence" lunacies, express the current *political intention* of the traditional Venetian financial-oligarchical mind. That is the intention to bring the existence of sovereign nation-states to an end, and to establish a certain form of world empire, called "globalization," today. The intention is now to eliminate the existence of the U.S.A., especially its already almost ruined economy.

This was already the pro-imperialist motive for the attacks on the work of Nicholas of Cusa, the author of the principle upon which the modern nation-state's original existence had been premised. It was the establishment of the first modern nation-states based on the commonwealth principle of our own

Federal Constitution later, Louis XI's France and Henry VII's England, which had been targeted for destruction by a resurgent, financier-imperialist Venice. So, the spread of religious warfare among formerly cooperating nation-states of Europe, was launched in the time of the Venetian spymaster Francesco Zorzi who operated, together with Norman pretender Cardinal

Pole, Thomas Cromwell, et al., in the role of marriage counselor to England's King Henry VIII. (See **Box 12.**)

The same issue presented in Aeschylus' *Prometheus Bound*, is the continuing leading issue within the entire span of the history of now globally extended European civilization, from that time to the present day. The issue is the same oli-

Box 12

Zorzi's Venetian Attack On Renaissance Science

Were Francesco Zorzi (a.k.a. Giorgi) alive today, he might be described (as some Republicans have recently described their party's Vice President) as "a nefarious bastard." Zorzi, unfortunately, did have parents. He came from a very old family that was among the top ten ruling families in Venice. Zorzi's political role and his method of thinking should be seen from the standpoint of the historic significance of the institutions he represented. He was a top-level Venetian spy (sometimes recognized as a Franciscan friar) at a time when Venice was reacting against the potential unleashed by newly created sovereign nation-states. This reaction was directed, in large degree, against the political and scientific leadership of Nicholas of Cusa (whose ideas sparked the pro-nation-state Italian Renaissance). Zorzi was relied upon for the most serious matters of state, based on his personal bloodline. Much of the oligarchical wealth of Venice (then, history's greatest financial center) was piled high, through usury, in the course of its role as a promoter of religious war during the Crusades. They built up the precedent for what some wild-eyed nuts today promote as "globalization." The "Venetian Model" was the modern origin of much of today's anti-Franklin Roosevelt tendencies, such as: the hoarding of raw materials, currency speculation, outsourcing, and slave labor, as well as pre-emptive war against those who would disturb the Venetian "marketplace."

Just as the anti-nation-state forces in Britain and related U.S. networks moved

successfully after World War II to destroy the pro-"General Welfare" legacy of Franklin Roosevelt before they could continue their policy of genocidal looting of the planet, so did Venetian interests move rapidly against Cusa's influence and legacy before they could continue their accustomed status as the dominant financial-imperial force in the world.

So, ironically, Zorzi, as a personality, can only be truthfully defined "negatively," not simply from the standpoint of the evil he represented in-and-of-himself, but from the standpoint of his role as a Venetian agent against the modern nation-state and Cusa's legacy. As the driving force behind the famous Council of Florence (1438-40), Nicholas of Cusa led the way toward reconciliation within a Church split between East and West. Cusa would later organize for a dialogue among religions, to stop the insane Venetian-led plunge of the world toward religious conflict. He introduced, as the basis for statecraft, the idea that man is in the image of the Creator, and is therefore, capable of participating in the ongoing development of Creation.

This Renaissance idea was not only the basis for the spirit that presided over that Council of Florence itself, but was an outreaching commitment to bring this lofty concept rapidly into the realm of politics. For the first time, the New Testament, and ancient Greek, idea of *agape* became the basis for government. The two successive examples of this are, first, Louis XI's France and, second,

Henry VII's England. This produced the virtually immediate transformation of the physical terrain within those new nations, and more importantly, unleashed the creative potential of the individuals within those territories. The explosive growth of these nations was a revolution which overturned what Venice saw as its personal "strategic chessboard."

This never-before-seen capability for wealth-production, was not something that could simply be bought and sold with Venetian coins. More and more geniuses began to appear out of the environment fertilized by Cusa. Minds such as Leonardo da Vinci, Luca Pacioli, Kepler, Shakespeare, Marlowe, Leibniz, and many more contributed to the increased rate of new wealth introduced to societies' potential. Anyone who is familiar with oligarchism knows that this "agapic" approach of the nation-state was not to be tolerated by Venice. The Venetians rightly saw this new development as something that would loosen and ultimately break the system of war and usury, with which they had tightly gripped the world for three to four centuries. So for them, Cusa's influence had to be wiped out, especially his revolution in science.

The Franciscan Friar From Hell

One of the direct attacks on Cusa came from Zorzi himself (whom one might call the Franciscan friar from Hell). This attack on Cusa, which would (decades later) prompt a devastating rebuttal by Johannes Kepler, was written in a book of Zorzi's that gained wide influence, titled *De Harmonia Mundi* (Harmony of the World). This book became the inspiration for the Rosecrucians (a mystical cult), as well as freemasons (introduced into England by Zorzi), and similar weirdos. In it, Zorzi asserts that certain mystical rituals will give their initiates access to the symbols required to directly experience

garchical principle, the principle of reducing the great mass of the population to the condition of virtual cattle, which was otherwise characteristic of the Asian culture which the Delphi Apollo cult typified in the history of Europe from then to the present day.

That much said to keep our focus on the relevant, axiomat-

ic background issues for this chapter's featured topics. To that end, I shall focus now, directly, on the feature of the matter of cubic roots which drew leading Eighteenth-Century reductionists into selecting this subject as the pivot on which to aim their attack against Leibniz then.

As I have already emphasized, repeatedly, earlier in this



Nicholas of Cusa (1401-1464). He founded modern experimental science, reviving the method of the Pythagoreans and Plato. Zorzi attacked him directly.

God through the senses. In the context of a pre-emptive attack on anyone who might dare disagree with his symbol-minded magic, he launches a direct assault, by name, on Cusa's philosophical method, claiming that it relies too much on "mere reason." He says: "Those who retreat from the direct knowledge of the universe will retreat into *De Docta Ignorantia*." This *De Docta Ignorantia* is the name given, by Cusa, to his best-known book, which he writes to liberate scientific method from the dead ideas of Aristotle and other superstitions.

To get a fuller sense of the dramatic intensity of this fight, consider Christopher Marlowe's play, *Dr. Faustus*. This play was a platform for Marlow's direct attack on the political influence of Zorzi in England, including the strange, supersti-

tious doctrines spread by Zorzi's influential writings of that period. Marlowe attaches the well-known profile of Zorzi to the image of Mephistopheles who, at one point, arrives and is about to get Faustus to agree to give up his soul, in exchange for magical powers. Upon arrival, Mephistopheles is immediately denounced as "ugly" (as devils generally are), and is told to leave and come back with more flattering features: "Go and return an old Franciscan friar, that holy shape becomes a devil best." In Marlowe's play, once the devil returns in that preferred likeness of Zorzi, the deal is struck, and Faustus is led down a delusory path (much like Henry VIII) to his own doom. Both Marlowe and his friend William Shakespeare were actively engaged in blowing the cover for this "nefarious" political operation being run against England over an extended period. To say the least, they were ill-treated for their efforts.

Henry VIII's England (where Zorzi would be deployed in 1529) was founded as the second modern nation-state by his father, Henry VII, in 1485-86. Henry VII's humanist impulses were characterized by the educational reforms he supported, as well as the idea of the "Common Good" which inspired him to put an end to the "War of the Roses" (85 years of civil war) and the bloody tyranny of Richard III.

England, with its new potential, began to free itself from the looting power wielded by Venice. To this end (about 20 years before Zorzi was sent there), England joined the Vatican-led League of Cambrai, along with France, Spain, and others, that would accomplish what before seemed impossible: bringing the Venetian Empire to its knees. Despite their status as history's most powerful financial empire, the Venetians could not overcome the technologically and culturally superior potential of the nation-states arrayed against their

overextended global empire. So they were defeated. Unfortunately, on the eve of the planned invasion and dismantling of Venice, the Venetians saved themselves by bribing Pope Julius II, a man we can safely conclude was not the best Pope ever. This betrayal allowed Venice to maintain its financial empire and regroup after this "setback."

Venice learned the hard way that empires are made susceptible when nations, having a sense of political/economic sovereignty, peacefully work together to promote science-driven physical-economic cooperation. In this light, Venice immediately moved to break up certain alliances, especially that of England and Spain; resorting, of course, to its preferred method: religious warfare. Thus, what Venice could not defeat through direct military confrontation would be undermined through more indirect means. Thus, as Marlowe informs us, the Devil returned, very shortly thereafter, as "an old Franciscan friar."

Just as Zorzi spearheaded his efforts for religious war with an attack on Cusa, so did Kepler spearhead his effort to end those Venetian-sparked religious wars by a decisive attack on Zorzi, and a defense of Cusa.

Kepler's Attack on Zorzi

Kepler, like Cusa, was committed to liberating science from the idol-worshipping of sense-perception. His revolutionary method for astronomy not only determined what the actual planetary orbits were, but he succeeded in defining the principle of universal gravitation. Kepler published a book which he called *Harmonice Mundi*, an intentionally ironic choice of title, placing in his crosshairs the Zorzi whose book effectively shares that name.

Kepler's book, dedicated to King
Box 11 continues on next page

report, the central issue of this age-long controversy has been the notion of *power*. It was virtually inevitable, therefore, that the relevant science-hoaxsters of the so-called “Enlightenment” would choose the hoax perpetrated by D’Alembert, de Moivre, Euler, Lagrange, et al., as the pivotal feature of their attempted fraud against the entirety of the mod-

ern Cusa-Kepler-Leibniz legacy.

It is, therefore, that issue of *power*; as that notion is associated with the Pythagorean practice of *Sphaerics*, which comes into play in a very special, crucially important way, in the approach which Gauss adopts for his attack on the reductionists in his 1799 doctoral dissertation.

James of England, was a playful intervention into a political climate which had been affected decades earlier by Zorzi’s influence. To this purpose Kepler (an avowed follower of Cusa), not only directly attacked the “Zorzians” of his day, like Robert Fludd, but he also upheld Cusa’s method. He demonstrated, with his rigorous approach to science, a demystified knowledge of astronomy (as opposed to Zorzi’s astrology). In doing so, Kepler acted in a way that intended to determine the outcome of what was actually a political fight. The most explicit question for him was: Which world view would prevail, the Venetian/Aristotelian view of Zorzi, which asserts that humans are genetically determined “sense-perceivers” (because of its rejection of the existence of the sovereign individual human mind) or, the world view of Cusa and Plato, which hinges on the political idea that all minds have the potential to discover the principles of our reasonably organized universe?

Mephistopheles’ Old Trick

Venice responded to Kepler—not by defending the ideas of the deceased Zorzi, who had served them well while he lived (so much for loyalty!), but by putting Galileo forward, as a way to overshadow Kepler’s monumental achievements. Galileo’s empiricism, despite its “scientific” posture, is based on the same wild-eyed Venetian rejection of the human mind, which Zorzi possessed. Again, Mephistopheles returns with new features, but without changing the same old dirty underwear of oligarchical thinking: Impose the assumptions that will get fools to embrace their own shackles.

Understanding this Venetian attack on science, and its related method, is the only real way to understand how the Venetian system of Zorzi’s time operat-



The title of Kepler’s magnum opus, “Harmony of the World,” was ironically chosen as a polemic against Zorzi’s cultish tract of similar name.

ed. Just as Venice played both sides in its effort to destroy scientific progress, it employed the same duplicity to wipe out the Renaissance political environment in which that scientific progress occurred. The Venetian role in manipulating both the Reformation and the Counter-Reformation is typical of this. When the dispute arose concerning whether or not Henry VIII would be allowed to divorce Catherine of Aragon, there were many diplomatic alternatives to a violent break with the Church. Whatever the problems would have been otherwise, one thing is absolutely clear: Once Venice gets involved in a “sex scandal,” everybody gets screwed!

Francesco Zorzi’s influence guided the imperial pride and libido of the foolish Henry VIII into political tragedy. In 1529, Zorzi decided to augment his long resumé as a Venetian spy and diplomat by becoming a “marriage counsellor” to a horny and foolish king. Zorzi’s deploy-

ment into England was not a blind venture into “virgin” political territory. (Venice had an extremely sophisticated system of intelligence and diplomacy.) Henry had been sold on Zorzi’s status as an “expert” interpreter of old Hebrew text, particularly, because he was convinced that Zorzi would use this “expertise” to give a verdict in favor of a King’s divine right to “get some.” The deal went as planned. Zorzi ruled (like a character from Shakespeare’s *Merchant of Venice*) that the King could have all the pounds of flesh he wanted. Zorzi said that the Pope never had a right to annul Henry’s first marriage before he married Catherine. So that, legally, according to our sex counsellor, Henry never really married Catherine to begin with.

These hasty developments, including the “off with his head” command of the King, against Thomas More (another premature ejaculation arranged by Venice), caused England to lose its mind. The advice from Henry’s sex counsellor did succeed. It succeeded in making Henry a man that the ladies would die for, but it also succeeded in preparing Europe to give birth to more than a hundred years of religious war. (Some more honest sex advisor, amidst Hell’s bellowing flames, might ask that foolish King: “Well damn, Henry! Do you really think she was that good?”)

Were Zorzi alive today, he might have insinuated himself into political influence by posing as the sex counsellor that Vice President Cheney actually needs. He might advise Cheney to gain public support for his pro-torture, globalization, “mini-nukes” policy by saying publicly that Lynne Cheney’s imposition of strange habits in the bedroom is the origin of his desire to torture prisoners, and whip nations into submission. This kind of Vice would, of course, serve Venetian interests.

—Alex Getachew

The Shadow of ‘Power’

Look at the way in which silly reductionists, such as de Moivre, D’Alembert, et al., reacted to the encounter with what they called “imaginary” roots appearing within those cubic functions on which D’Alembert et al., focussed their attack on Leibniz’s discovery of the catenary-linked universal principle

of universal least-action, the fundamental physical principle of the Leibniz calculus as a whole. (See **Box 13**.)

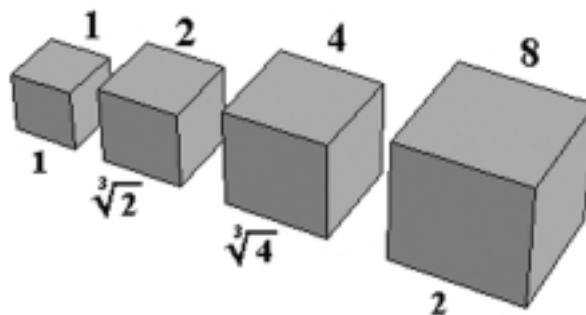
Now, consider the opening several elements of the expression of a “Fundamental Theorem of Algebra” in Gauss’s 1799 doctoral dissertation. Compare this series of terms with the Pythagorean notion, defined in terms of *Sphaerics*, of the dis-

Box 13

How Cubic Roots Are Defined Algebraically


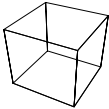
From the Greek studies of the line, square, and cube came an understanding of simply, doubly, and triply extended self-similar action. For example, the triply extended action of a cube necessitates two means between the extremes. This gives an idea of cubic roots (**Figure 1**).

FIGURE 1



It is easy enough for us to retrospectively apply the symbols x , x^2 , x^3 to lines, squares, and cubes, respectively. But to what geometry do x^4 , x^5 , etc., correspond? (**Figure 2**)

FIGURE 2

x	x^2	x^3	x^4
—			?

One solution to this paradox (preferred by petulantly childish formal mathematicians) is shown in **Figure 3**:

FIGURE 3

x	x^2	x^3	x^4

Ah, what a relief—with that pesky geometry out of the way, we can enjoy the unfettered freedom of manipulating symbols with assumed self-evident properties! We can simply recognize that x^3 means x times x times x ; no troubles here! We can add and subtract too! $5-3 = 2$. And if we want $2-6$, we’d get -4 . Hmm, that’s a new type of number I did not mean to make with my self-evident numbers, but what of it?

Continuing, we can make equations: like $x^2 = 4$, which we can solve with $x = 2$,

and also our “negative” number $x = -2$. We could even say $x^2 + 4 = 0$, which has as its answer. . . Well, let’s see. . . Using the rules of algebra, $x^2 = -4$, but what on earth squared is -4 ? Both 2^2 and $(-2)^2$ are $+4$, not -4 . Well, even if it makes no sense, we can use our rule to take the square root of both sides and get $x = \sqrt{-4}$. Now, this corresponds to no real magnitude, but, who cares? Let’s use it anyway!

In fact, looking at $x^3 = 8$, we get no less than three solutions, only one of which even makes sense: 2 , $-1 + \sqrt{-3}$, and $-1 - \sqrt{-3}$! Where are these strange numbers coming from? What is the source of these foreign intrusions into *my* view of the universe? Don’t I have the personal right to look at things from my own point of view?

—Jason Ross

tion we have already noted, in the preceding chapter, among rational, irrational, and transcendental number-series. It should be readily seen that Gauss's conception of algebra is not *ontologically* arithmetic, but a geometrical approach consistent with the principles of *Sphaerics*. (See **Box 14**.)

Therefore, define the set of cubic roots with which the Eighteenth-Century reductionist Leibniz-haters were wrestling in terms of the proof of the *ontological* implications, respecting cubic roots, for the related case of the geometrical construction of the doubling of the cube. Aha! There is now clear-

Box 14

Gauss's Geometrical Approach to Algebra

As Gauss devastatingly exposes in his 1799 doctoral dissertation, the approach to algebra as being ontologically arithmetic fails to explain itself: Algebra fails, internally, to prove what became known as the fundamental theorem of algebra.¹

To clarify, consider Gauss's description of d'Alembert:

"It is proper to observe, that d'Alembert applied geometric considerations in the exposition of his proof and looked upon X as the abscissa, and x as the ordinate of a curve (according to the custom of all mathematicians of the first part of this century to whom the notion of functions was less familiar). But all his reasoning, if one considers only what is

essential, rests not on geometric but on purely analytic principles, and an imaginary curve and imaginary ordinates are rather hard concepts and may offend a reader of our time. Therefore I have rather given here a purely analytic form of representation. This footnote I have added so that someone who compares d'Alembert's proof with this concise exposition may not mistrust that anything essential has been altered."

Compare this with Gauss's presentation of the ontologically geometric complex domain.

Gauss begins the portion of his dissertation concerning his own demonstration with two introductory lemmas, where he introduces two equations:

$$(1) \quad r^m \cos m\varphi + Ar^{(m-1)} \cos(m-1)\varphi + Br^{(m-2)} \cos(m-2)\varphi + \dots + Krr \cos 2\varphi + Lr \cos \varphi + M = 0,$$

$$(2) \quad r^m \sin m\varphi + Ar^{(m-1)} \sin(m-1)\varphi + Br^{(m-2)} \sin(m-2)\varphi + \dots + Krr \sin 2\varphi + Lr \sin \varphi + M = 0,$$

He then begins his proof proper:

"The outstanding theorem is frequently proved with the help of imaginary numbers, cf. Euler *Introd. In Anal. Inf. T.I. p 110*; I consider it worth the trouble to show how it can easily be elicited without their help. It is quite manifest that for the proof of our theorem nothing more is required than to show: *When any function X of the form $x^m + Ax^{(m-1)} + Bx^{(m-2)} + \dots + Lx + M$ is given, then r and φ can be determined in such a way that the equations (1) and (2) hold.*"

Not only does he claim that he will not use imaginary numbers, but he seems not even to use algebra! These equations (1) and (2) do not involve x in any way, but only r and φ .

To understand Gauss's use of these two equations (1) and (2), let's re-approach our earlier paradox, introduced in Box 13 (**Figure 1**):

We have lines, squares with one mean, and cubes with two means. What form could correspond to a greater number of means, or an indeterminate number of

means? What Jakob Bernoulli reported as his *spira mirabilis* (miraculous spiral) provides us a lead (**Figure 2**).

Such a spiral combines two forms of action, known as arithmetic (simple, repeated addition) and geometric (simple, repeated multiplication). The amount of arithmetic angular change and geometric increase of distance are combined as one action: Thus, doubling the rotation squares the multiplied length, tripling cubes it, and quadrupling gives us a geometric understanding of x^4 , x^5 , x^6 , and so on, as high as you like.

The unbridgeable gap between linear, square, and cubic action, and the mystery of higher forms of action, have been solved by introducing a single curve, which, by multiplying the amount of rotation, can create all of these relationships. Thus the equiangular spiral brings what seemed infinite, to the finite, and encompasses a before-then disparate class under one idea of action, which action Leibniz called logarithmic.

Now, there are many spirals that could be drawn, spirals which grow more or less quickly. Let us interest ourselves in the extremes: a straight line (pure extension, without rotation) and a circle (pure rotation, without extension) (**Figure 3**):

Inspect the circle (**Figure 4**): What form of number does it require? Call one location 1, and, naturally, its opposite -1:

Note that our earlier spiral relationship still holds: The 180° rotation to get to -1, when doubled to 360°, puts us at 1, which is (-1)². But what of the other locations on the circle? To what numbers do they correspond? They cannot all be 1, for they are different places (**Figure 5**).

Maintaining our principle, (?)² would be -1 by the logarithmic property doubling rotation on our spiral. This makes (?) = √-1, and its opposite, -√-1 (**Figure 6**).

The "imaginary" numbers, although

ly something “in between” the algebraic elements of such a generalized cubic function, something which corresponds, *ontologically*, to the implications of Archytas’ construction. If we generalize all of the algebraic forms of the set of cubic roots to include the “factor” of the so-called “imaginary”

aspect, we have a composite picture of visible forms which are connected functionally by a *form of action* which is not visible, but we can nonetheless represent and treat as a geometrical action of a special kind. *It exists!* (See **Box 15.**)

To see more clearly what is going on in the mind of the rel-

FIGURE 1


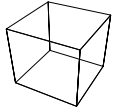
x	x^2	x^3	x^4
—			?

FIGURE 3

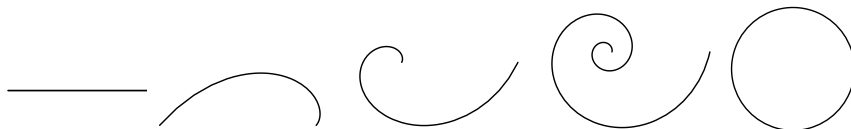


FIGURE 4

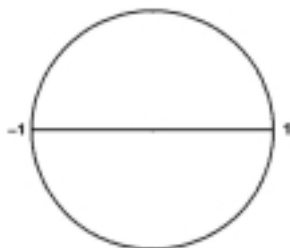


FIGURE 5

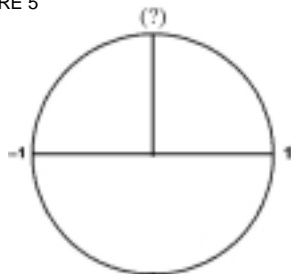
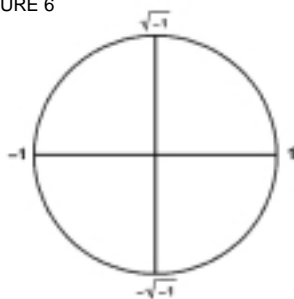


FIGURE 6



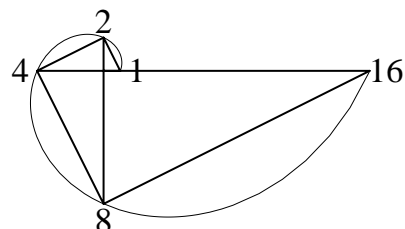
not existing on the number line, *do exist*, lying outside the blinders of formalists. Extending these actions, we create the complex domain.

“Suppose, however, the objects are of such a nature that they cannot be ordered in a single series, even if unboundedly in both directions, but can be ordered only in a series of series or, in other words, form a manifold of two dimensions; if the relation of one series to another or the transition from one series to another occurs in a similar manner, as we earlier described for the transition from a member of one series to another member of the same series, then in order to measure the transition from one member of the system to another, we shall require in addition to the already introduced units $+1$ and -1 two additional, opposite units $+i$ and $-i$. Clearly we must also postulate that the unit i [$\sqrt{-1}$ -ed.] always signifies the transition from a given member to a *determined* member of the immediately adjacent series. In this manner the system will be doubly ordered into a series of series.”³

Now, how can we represent change in this complex domain? With “normal” numbers, squaring can be represented thus (**Figure 7**):

Each of these right angles combined *Box 14 continues on next page*

FIGURE 2



*Bernoulli’s logarithmic, self-similar spiral.*² The 90° rotation of going from 1 to 2, repeated four times to 360° , gives a length of 16, which is 2^4 .

FIGURE 7

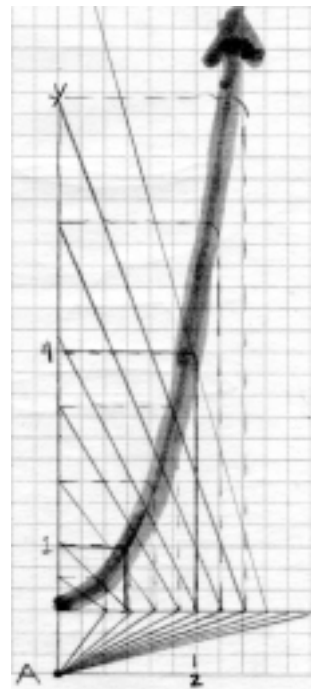


Image courtesy of Mike Vander Nat

Lines drawn from A to the horizontal axis make right-angle turns to intersect the vertical axis. The combination of the points on the two axes forms a parabola.

evant Eighteenth-Century Berlin gaggle using their reading of the cubic-roots case for an attempt to discredit Leibniz, look at a related production by Euler, which I had referenced more than a decade ago.

At this point, we are preparing to focus on the matter of the development of the concepts of the Biosphere and Noösphere by Russia's V.I. Vernadsky. Vernadsky's work revives, thus, but in a new approach, that traditional epistemological distinc-

FIGURE 8

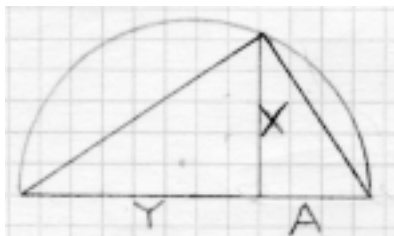


Image courtesy of Mike Vander Nat

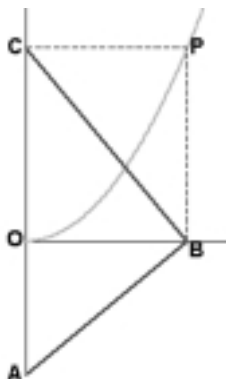
with the axis can be thought of as making two similar triangles, making the ratio $A/X = X/Y$ (Figure 8). We then get $AY/X = XY/Y$, and $AY/X = X$, which gives $AY = X^2$. So, when $A = 1$, $Y = X^2$ (Figure 9).

Each horizontal motion is "wedded" to a vertical change of squared relationship to the horizontal. Their union, the parabola, expresses the process of squaring.

But what if we take the entire complex field? This is a two-dimensional space, and each result of squaring is two-dimensional as well. Together, that makes four dimensions! No wonder d'Alembert, "rests not on geometric but on purely analytic principles"

Gauss resolved this with the logarithmic spiral. If each rotational doubling squares length, we could express any location $(a + b\sqrt{-1})$ as $r(\cos\phi + \sqrt{-1}\sin\phi)$ (Figure 10).

FIGURE 9



Combining a number of these triangles creates the parabola

And, squaring it spirally, we get $r^2(\cos 2\phi + \sqrt{-1}\sin 2\phi)$.

Do you recognize anything from Gauss's 1799 paper? Gauss simply applies this transformation to his entire algebraic equation $X = x^m + Ax^{(m-1)} + Bx^{(m-2)} + \text{etc.} + Lx + M = 0$, creating for each x , $r(\cos\phi + \sqrt{-1}\sin\phi)$ instead, and producing:

$$(1) \quad r^m \cos m\phi + Ar^{(m-1)} \cos(m-1)\phi + Br^{(m-2)} \cos(m-2)\phi + \dots + Krr \cos 2\phi + Lr \cos\phi + M = 0,$$

and

$$(2) \quad r^m \sin m\phi + Ar^{(m-1)} \sin(m-1)\phi + Br^{(m-2)} \sin(m-2)\phi + \dots + Krr \sin 2\phi + Lr \sin\phi + M = 0.$$

This keeps separate the parts with and without $\sqrt{-1}$, geometrically constructing two surfaces, where d'Alembert only falsely ruminated on one, non-existent curve (Figure 11).

From these beginnings, Gauss is able, in his 1799 paper, to simply and elegantly

use the ontologically transcendental geometric nature of number to demonstrate a characteristic (the fundamental theorem) of its shadow, algebra. How foolish are those who seek to explain the universe by imagining that its shadows are reality!

—Jason Ross

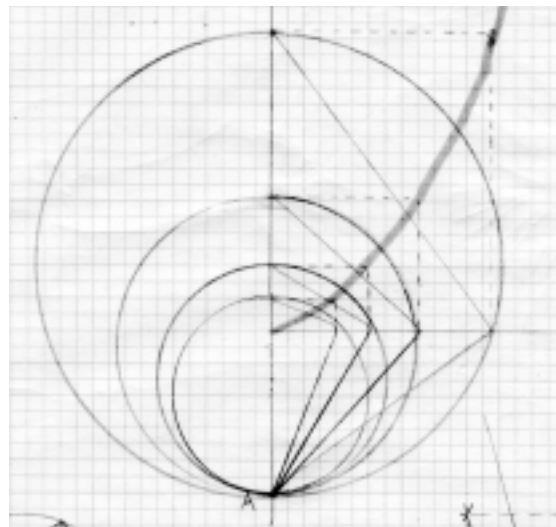


Image courtesy of Mike Vander Nat

Notes

1. How much time, effort, and money is annually wasted by students attempting to explain "financial economics" from monetary theory? Perhaps they could put their time to good use by providing a thorough accounting of such waste, *per annum*.

2. Bruce Director, "Gauss's Declaration of Independence" and "Bringing the Invisible to the Surface," *Fidelio*, Fall 2002.

3. Carl Gauss, "The Metaphysics of Complex Numbers," translated from Gauss's *Werke*, Vol. 2, pp. 171-178, by Jonathan Tennenbaum in *21st Century Science & Technology*, Spring 1990.

See <http://www.wlym.com> and <http://www.wlym.com/~jross/gauss/> for Gauss's referenced paper and work by the LYM on Gauss's 1799 paper.

tion among the categories of non-living, living, and human cognitive processes, which has been characteristic of European history since Thales, the Pythagoreans, Solon of Athens, Heraclitus, the Pythagoreans, Socrates, and Plato.

The opposition to this scientific outlook has been, as I have already stressed in the preceding chapter, the method of using a childish conception of arithmetic as a substitute for a physical geometry of the type associated with the Pythagoreans. The

FIGURE 10

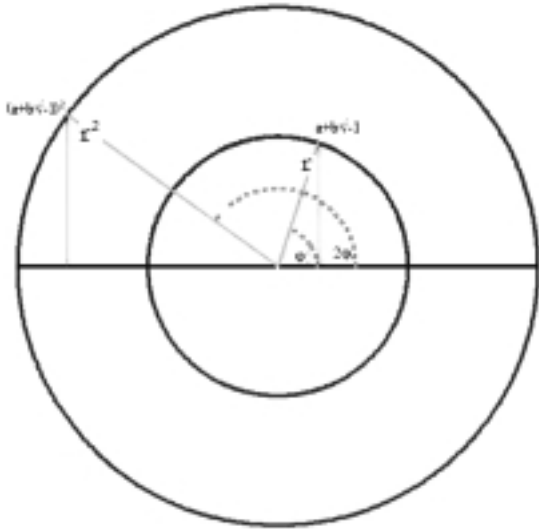


FIGURE 11



EIRNS/Dan Sturman

A geometric construction corresponding to Gauss's Fundamental Theorem of Algebra (right), created by the LYM in Philadelphia.

result of that substitution, whether in ancient Greece or modern society, has always been a certain specific type of mystification of the undeniable functional distinctions among so-called rational, irrational, and transcendental series, as the

overview of these elementary series was defined for modern reference by Eratosthenes. His work should be read correctly from a geometric, rather than algebraic standpoint. (See **Box 16.**)

Box 15

Doubling the Square, The Cube, and Cubic Roots

In these investigations of doubling the square, doubling the cube, and other challenges LaRouche has laid out, we find we must make a lot of constructions. If the faithful reader has not chickened out, and has begun the process of fighting with these problems, he has run into two things. First, a certain amount of frustration, a “fire in the butt,” that provokes those industrious souls to do more work. Second, a sense that the investigation isn’t really about doubling the square or doubling the cube, after all.

Compared to doubling the square, the doubling of the cube is a conundrum, and an order of magnitude more difficult to discover. The cube is characteristic of the visible universe, as Plato describes in the *Timaeus*: It provides surfaces and lines to our mind’s eye, as parts of itself. The seemingly more elementary line and plane do not have independent existences

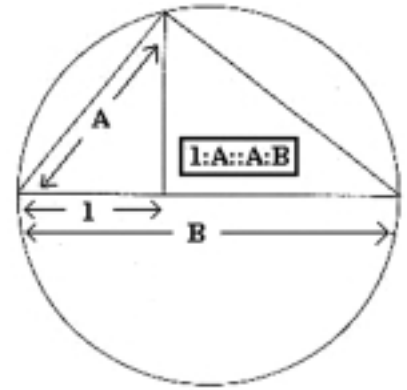
(except in Flatland). We see lines and planes only because visible space is “cubical,” i.e., *spherical*. But, we never actually see the cube. Part of it is always hidden from sight. We need multiple views of the same object by which the mind constructs an idea of the object’s complete appearance.

Questions regarding the universe in its entirety are found there, but they are just out of sight. When we try to pin them down, they seem to move just out of reach. What did Archytas see in the cube? He knew that it requires a concert of circular actions to produce, and he knew that those actions are ordered by powers outside the cube. D’Alembert and de Moivre, on the other hand, wanted to torture the cube; they wanted to force it to submit, to give up its depth, to make it become just one more surface. They wanted to force the life out of it so

they could make it an equation and pin it in their entomological box, next to the *Lepidoptera*. They wanted to stop you from recognizing the power of discovery inside your own mind.

Think back to when you discovered how to double the square. (Double the square right now, if you haven’t already!) What images went through your mind? Perhaps opening your mail, or cutting a piece of toast, or folding your sheets. Often, something you don’t ordinarily associate with geometry, be-

FIGURE 2



One mean between two extremes, inside the circle.

comes the inspiration by which you generate the discovery. But, each of these images is an experience your mind actually recognizes, as containing the crucial species of action that doubles the square. Was that discovery thus already somewhere in your mind, or was it a brand new creation?

Now, compare the doubling of the square with doubling the cube. We’ve seen that doubling the square and the cube both require circular actions (**Figure 1**).

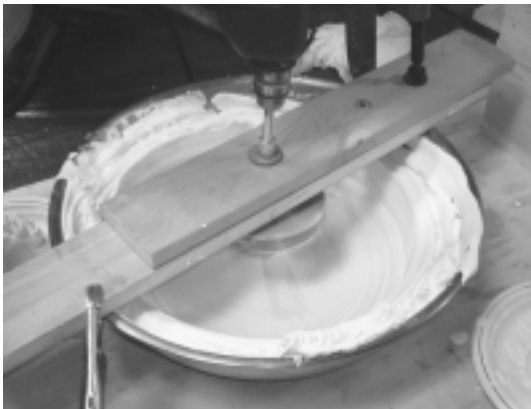
Finding one mean between two extremes, to generate all the square magnitudes, can be represented as instances inside one circular action (**Figure 2**).

Finding the construction for creating two means between two extremes, according to Archytas, demands an additional circular action, orthogonal to that action which has the power to generate square magnitudes (**Figure 3**).

So, we see that the square powers are really a shadow of that principle that generates cubic magnitudes. Recall that, when one sees a cube, one is really piecing together a set of images of squares and lines, which are projections from the cube, which you can’t see.

Fast forward to the entrance of Carl

FIGURE 1

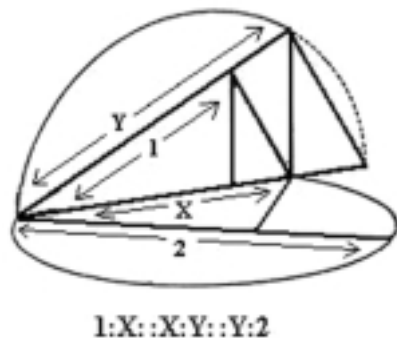


The circular action required to build the torus, is invisible to your senses. See Box 3.

For the Pythagoreans and the circles of Socrates and Plato, as for Carl Gauss's refutation of D'Alembert, Euler, et al., in Gauss's 1799 doctoral dissertation, categorical distinction among rational, irrational, and transcendental, was not a practi-

cal conceptual problem in a competent view of science in general. For competent science, these differences are differences in species of the physical existence being measured. Numerology seeks to derive physical species from counting numbers; sci-

FIGURE 3



Two circular actions, orthogonal to each other, generate two means between two extremes.

Gauss into the fight. He defined the roots of all algebraic equations, as the intersection of two surfaces, generated by multiply-connected circular action, intersecting at a plane. Looking at this through Gauss's eyes, the algebraic equation is not the determining power, but is produced as an effect of the gross characteristics of the

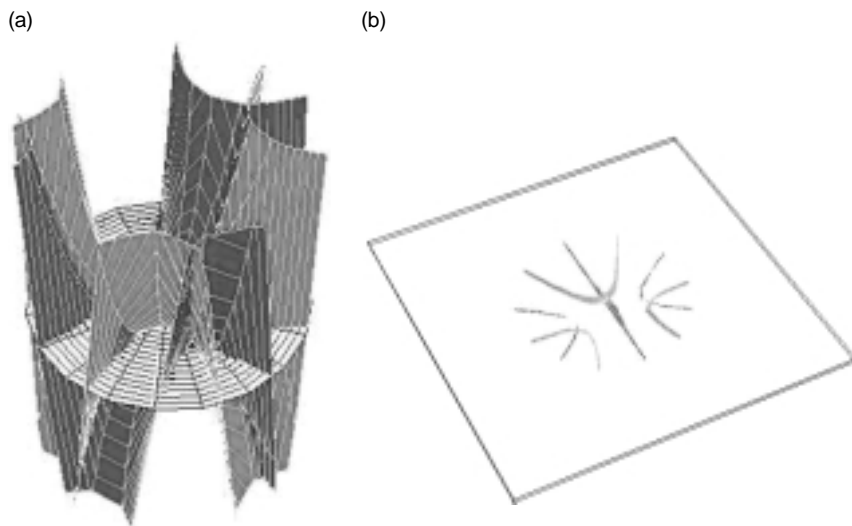
two surfaces. For example, the roots of a cubic equation are really the intersections of three surfaces, two of which shoot up to infinity three times in one rotation (Figure 4).

The roots are thus an integral aspect of the entire surface geometry, just as the two means are effects of the intersection of three different curved surfaces. Unlike Archytas' cubic construction, though, Gauss's surfaces can be constructed to generate any power.

What do these constructions say about visual space? When we see objects such as cubes, are we really seeing what we think we see? Or, are we seeing a metaphorical representation of something, lurking behind the senses, which ironically also generates what we now recognize as the Archytas construction, or Gauss's construction of algebraic roots? Only from this type of ironical study, can we begin to scientifically pin down the source of that eerie "behind the scenes" notion.

—Riana St. Classis and Peter Martinson

FIGURE 4



The two surfaces for a cubic equation (a), and the curves formed by their intersection with the plane (b).

ence seeks to perfect a mathematics reflecting the distinct species of physical composition in the universe as a whole. Exploring the elementary distinctions among point, line, sur-

face, and solid is the anteroom of physical-scientific thinking as a whole. In this aspect of the subject, the nastiest of all problems has been the conception of the *point*. What, physically, is

Box 16

Eratosthenes' Sieve

"First of all, though they had eyes to see, they saw to no avail; they had ears, but they did not understand; but, just as shapes in dreams, throughout their length of days, without purpose they wrought all things in confusion. They had neither knowledge of houses built of bricks and turned to face the sun nor yet of work in wood; but dwelt beneath the ground like swarming ants, in sunless caves. They had no sign either of winter or of flowery spring or of fruitful summer, on which they could depend but managed everything without judgment, until I taught them to discern the risings of the stars and their settings, which are difficult to distinguish.

Yes, and numbers, too, chiefest of sciences, I invented for them, and the combining of letters, creative mother of the Muses' arts with which to hold all things in memory. . . ."

—Prometheus, speaking in Aeschylus's Prometheus Bound

This astronomical origin of number and its connection to man's economic development, enunciated by Prometheus, is at the heart of the only truthful approach to science. Nevertheless, since that time, Zeus's would-be minions, who have sought to prevent the emergence of new Prometheans, have tormented countless generations by substituting for this physical-geometric origin of number, a sophisticated form of arithmetic that associates number with merely the counting of things. Thus, the restoration of sanity in economics, so urgently needed today, is linked to jettisoning those infantile notions of arithmetic, used by bankers, accountants, and statistical physicists, replacing such foolishness with the higher notions of number associated with Plato,

Eratosthenes, Cusa, Fermat, Leibniz, Gauss, Dirichlet, and Riemann.

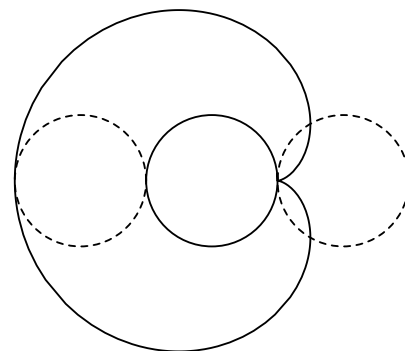
A simple pedagogical way to begin to demystify number's astronomical origins, and restore mental health to the victims of digital computers, is to examine the example of the most recognizable astronomical cycles, the Earth day, lunar month, and solar year. Each cycle is a physically completed action. Thus, each cycle lays claim to the number one. Yet all three exist in One universe. As such, there must be a greater One that subsumes these *relative* ones. Number, as Plato, Eratosthenes, Cusa, Leibniz, and Gauss understood it, unfolds from such relationships among these *relative* ones when they are considered with respect to a greater unity. This is why Cusa said, in *On Conjectures*, "The essence of number is the prime exemplar of the mind."

Thus, when one of these cycles is considered as one, the others become multiples of that one. For example, when the Earth day is taken as one, the lunar month contains a multiple of days. After 29 Earth days the lunar cycle is almost complete, but not quite. The Earth will complete another cycle before the Moon completes its cycle. From this standpoint, one lunar month and one Earth day are *relatively* incommensurable. However, after two lunar cycles, the Earth and Moon will return to their original orientation.

Now add the solar cycle. Compare that with the lunar and Earth cycle individually, and all three together. Note the mutual commensurability and incommensurability of the cycles.

From this type of astronomical-physical determination of number, the Pythagoreans understood the existence of two species of numbers: the rational numbers associated with cycles that ultimate-

FIGURE 1



ly become commensurable, and irrational numbers associated with cycles that are inherently incommensurable.

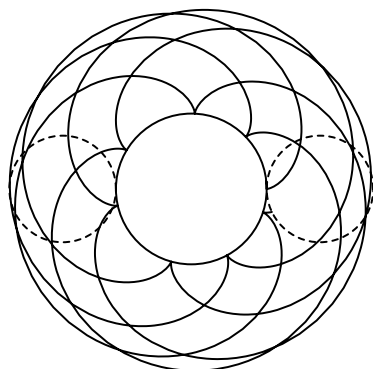
To grasp this point, think of two cycles, represented by circles of equal sizes. Allow one circle to roll along the circumference of the other. After one rotation of the rolling circle, the two circles will be in the same relationship as at the beginning of the cycle (Figure 1). Now, let the diameter of the rolling circle decrease, and examine the effect of this decrease on the commensurability or incommensurability of the cycles. There will be some relationships in which the two circles are incommensurable (Figure 2). There will be others in which the rolling circle completes its cycle after a finite number of rotations. These commensurable numbers are called whole numbers, 1, 2, 3, 4, . . . and rational numbers, 2/3, 5/4, etc. (Figure 3).

But this is a "bottom up" approach. Now look at the same generation of numbers from the "top down." Instead of creating these rational proportions by first creating whole numbers 1, 1+1, 1+1+1, etc., begin with a concept of the One and derive the whole numbers as parts. To express this geometrically, take a circle as the One and divide it. Halving the circle produces two parts, and thus the number 2. Halving again produces four parts, and the number 4, halving again eight parts, etc. But while this process will produce

a point? That, Euler seems never to have understood, which is why he joined the reductionist horde in his savage, and also intellectually childish attack of 1761 on Leibniz. (See **Box 17.**)

Actually, a point is a kind of idea corresponding to an image of an anything which attempts to appear to be nothing. *LaRouche text continues on page 64*

FIGURE 2



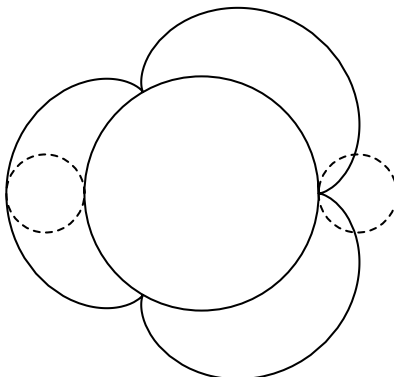
ever greater divisions of the circle, and the series of whole numbers, 2, 4, 8, 16, etc., such a process will never divide the circle (One) into three parts.

To divide the circle into three parts, and thus obtain a concept of the number 3, requires an entirely different action. Once this is accomplished, the three parts can be halved to produce 6 parts, and halved again to produce 12. Also, each of the three parts can be divided again into three parts producing 9, and continuing to 27, etc. From this process the divisions into powers of 3, powers of 2, and multiples of the powers of 3 and 2 are formed. But such a process, although producing an infinitude of possible divisions, will never divide the circle into 5, 7, or 11 parts.

These types of numbers, 2, 3, 5, 7, 11, etc., which cannot be formed by combinations of other divisions, but from which other divisions can be formed, were recognized by the Greeks as the “prime” numbers. Thus, the prime numbers are the numbers from which all other numbers are made.

The very existence of prime numbers is already an indication of the foolishness of thinking of numbers generated by the childish method of adding 1, and defining an arithmetic by the for-

FIGURE 3



mal operations of addition, subtraction, multiplication, and division. Each such operation, rather than being a set of rules, must be understood, as the very existence of prime numbers attests, as a different type of physical action.

A still deeper concept is revealed when one seeks to find the cycle that produces prime numbers. From the bottom up approach of adding 1, the prime numbers seem to appear suddenly without warning. Sometimes two appear near each other, such as 11 and 13, and sometimes there are several numbers in between, such as 23 and 29. While the density of the prime numbers decreases as the numbers get larger, they never cease to appear.

Thus, to even find the prime num-

bers—the numbers from which all other numbers are made—the bottom-up approach must be abandoned for the domain which Gauss called “higher arithmetic.” That domain treats the entire class of numbers as a One, and all numbers are considered with regard to their relationship to that One. But since the number of numbers is infinite, we must think of that One, from the physical-geometric conception of number associated with the astronomical origin of number enunciated by Prometheus.

A Higher Concept of Number

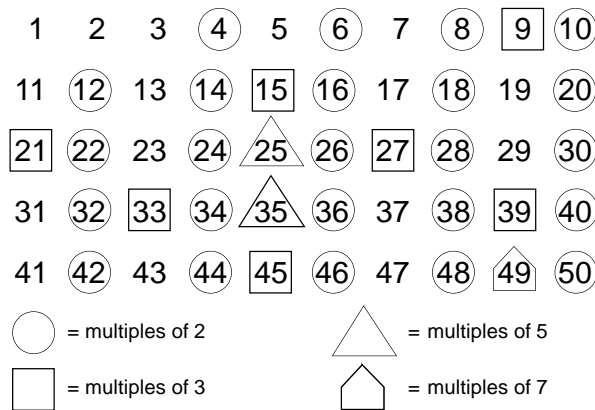
This higher concept of number is expressed by the method of finding the prime numbers created by Eratosthenes, which he called a “sieve.” The sieve takes all the numbers as its beginning, and extracts the primes in a similar manner to the above illustration of the divisions of the circle.

To construct Eratosthenes’ sieve, create an array of numbers from 1 to any upper bound. Then, beginning with 2, pull out from the array all multiples of 2. Then go to the next highest number that was not extracted, which would be 3. Extract from the array all the multiples of 3. When this is exhausted, go the next highest number after 3 that was not extracted, which would be 5. Continue this process. The sieve will extract all prime numbers from the array (**Figure 4**).

In this way, the existence of a more complex cycle begins to emerge, the cycle of prime numbers, that reflects the complex geometrical structure of the physical universe itself. That structure was investigated further by Fermat, Gauss, Dirichlet, and Riemann. The depth of those insights is beyond the scope of this short report, but their investigation, as Plato said, draws the mind closer to truth and being.

—Bruce Director

FIGURE 4



Box 17

Euler Misses the Point

“The monad . . . is nothing else than a simple substance, which goes to make up composites; by simple, we mean without parts. Now, where there are no constituent parts, there is possible neither extension, nor form, nor divisibility. These monads are the true atoms of nature, and, in fact, the elements of things.”

—Gottfried Leibniz, *The Monadology*

In a direct attack on this concept of the monad and its author, Gottfried Wilhelm Leibniz, Leonard Euler wrote, in a 1756 letter to a German Princess, an argument to disqualify those who “insist that division extends only to a certain point, and that you may come at length to particles so minute that, having no magnitude, they are no longer divisible. These ultimate particles, which enter into the composition of bodies, denominate *simple beings* and *monads*.”

“This property [of division] is undoubtedly founded on extension; and it is only insofar as bodies are extended that they are divisible and capable of being reduced to parts.”

“You will recollect, that in geometry it is always possible to divide a line, however small, into any number of equal parts.”¹

“Whoever is disposed to deny this property of extension is under the necessity of maintaining that it is possible to arrive at last at parts so minute as to be unsusceptible of any further division, because they cease to have any extension. Nevertheless, all these particles taken together must reproduce the whole, by the division which you acquired them; and as the quantity of which would be *nothing*, a combination of nothings would produce quantity, which is manifestly absurd! For you know perfectly well that in arithmetic two or more nothings joined never produce any thing.

“This opinion, that in the division of extension or of any quantity whatever, we come at last to particles so minute as to be

no longer divisible because they are so small or because quantity no longer exists, is therefore a position absolutely untenable.”

But wait a minute! This argument by Euler against the monad sounds suspiciously like a familiar argument made by Gottfried Leibniz in his *Dialogue on Continuity and Motion* years before, where he poses this problem:

Pacidius: In a rectangular parallelogram, let a diagonal *NM* be drawn (Figure 1). Isn’t the number of points in *LM* the same as the number in *NP*?

Charinus: Without doubt. For, since *NL* and *MP* are parallel, *LM* and *NP* are equal.

Pacidius: Now, any horizontal line drawn from a point on the line *LM* to the line *NP* will have a corresponding point on *NP* as well as on the diagonal *NM*. However, either there are extra points on the diagonal *NM* which could not be intersected, or the line *NM* has the same number of points as *LM* and *NP*, which would be absurd! However, conversely, one can draw a horizontal line from any point left on the diagonal to a corresponding point on each of the sides! Whence it is established that lines are not composed of points.

So wait, what’s going on here? Leibniz, the author of *The Monadology*, the paper which first laid out not only the existence, but also several of the main characteristics of monads extensively, argued for infinite divisibility and the impossibility of lines made up of points! So, both the subject of Euler’s attack, as

FIGURE 1

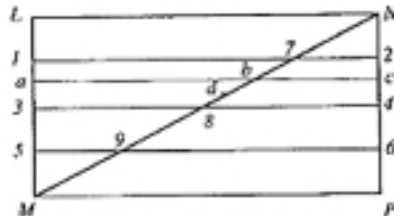
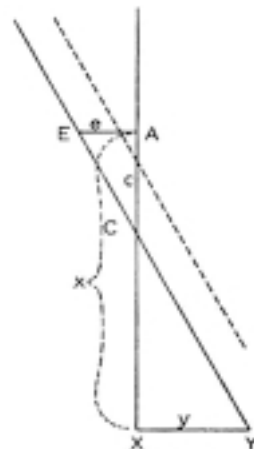


FIGURE 2



well as the attack itself came from Leibniz! Now, ask yourself this: Could it be possible that an 11-year student of Jean Bernoulli just didn’t realize this?

Maybe Euler, intentionally or unintentionally, missed the point.

Let’s look at some other points:

Leibniz posed this investigation in a different way in a letter to Pierre Varignon in 1702, where he describes the following construction:

“Let two straight lines *AX* and *EY* meet at *C*, and from point *E* and *Y* drop *EA* and *YX* perpendicular to the straight line *AX*. Call *AC*, *c* and *AE*, *e*; *AX*, *x* and *XY*, *y*. Then since triangles *CAE* and *CXY* are similar, it follows that $(x-c)/y = c/e$ (Figure 2).

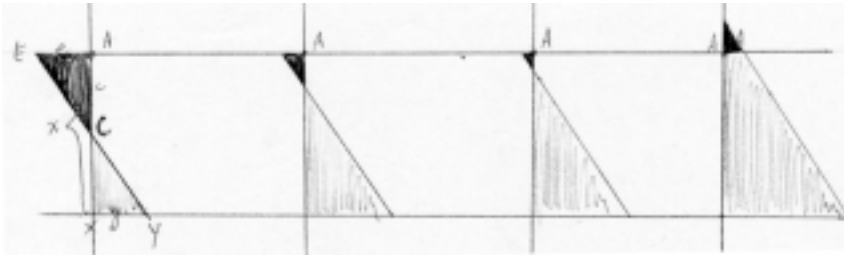
“Consequently, if the straight line *EY* more and more approaches the point *A*, always preserving the same angle at the variable point *C*, the straight lines *c* and *e* will obviously diminish steadily, yet the ratio of *c* to *e* will remain constant.” (Figure 3)

What happens when *E* and *C* lie on *A*? (Figure 4)

At the vanishing point *A*, the relationships must still hold. But how can a point be a triangle? How many sides does this point have? Are all points created equal?

This type of true point can only be generated through a process, the denial of which is the real sophistry that Euler is employing. In a dead fantasy-mathematical world where points are just material nothings, you *can* divide anything *ad infinitum*, and free trade *is* good for humanity.

FIGURE 3



What is a point in the real world then? Let's take a look at the problem of trying to divide the nation-state:

We begin with the nation-state itself, which was born as an expression of scientific breakthroughs in natural law, i.e., a body of people most closely organized according to the same principles as the universe itself, a self-governing, self-bounded entity. Now ask yourself how one could go about dividing the nation-state such that each part maintains the same sovereignty as the whole; or, as Leibniz put it, "because it [matter] is divided without end, every part into other parts, each one of which must have its own proper motion. Otherwise, it would be impossible for each portion of matter to express all the universe" (*The Monadology*).

The United States has 50 states, each with its own internal government, transportation system, power systems, agriculture, etc., and yet, each an integral part of the nation-state as a whole. The next such

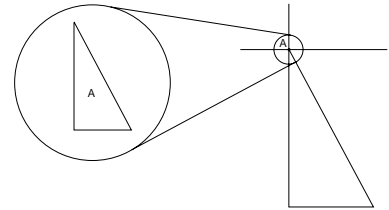
division is the county, and the city, with its own teachers, engineers, merchants, etc. Then we have the household, and finally, the individual citizen. The individual citizen is a sovereign entity, with the mind as its governing apparatus, and all its organs and arteries, which serve their own separate functions, but governed by a single intention, to serve the whole; an entire nation-state within one individual . . . or, is it the other way around? Has the nation-state been organized like the individual?! Such that the more diverse the occupations (organs), the more complex and efficient the operation of the whole; and each citizen, like the cells that make up all the parts of the body, are specialized but express one intention, the betterment of that whole.

To more clearly show the political attack by the mathematically imprisoned Euler, let's put him in power. How would he divide the nation-state?

Here we go:

Divide the country into North and

FIGURE 4



South sections. Then into Northeast, Northwest, Southwest, and Southeast, by drawing a line down the center vertically, then into eighths, sixteenths, and so on to infinity. (Figure 5)

Be careful not to get in the way, this may get bloody.

—Liona Fan-Chiang

Notes

1. Try it! Take a line and divide it into 10 parts:

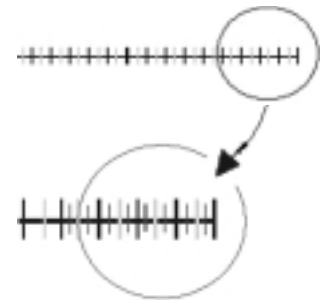


Then, take each part and divide it in half:



Now, these segments in turn can be divided in half again, and again, and again, into infinity, or until you get tired (you may need a laser).

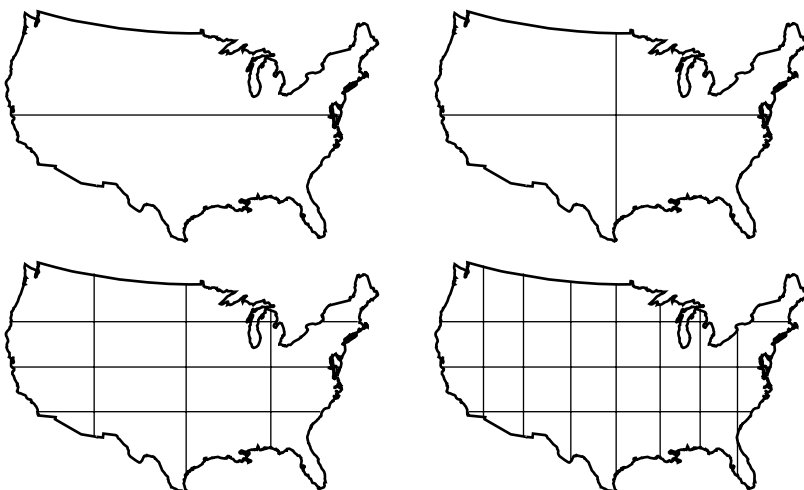
In fact, no matter how small the segment gets, as long as it has any length, you could just get a magnifying glass and keep on dividing. "Hence it is affirmed that all extension is divisible to infinity; and this property is denominated divisibility in infinitum.



References

Gottfried Wilhelm Leibniz, *Monadology* (Buffalo, N.Y.: Prometheus Books, 1992).
 Leibniz, *Dialogue on Continuity and Motion*.
 Leibniz, *History and Origins of the Calculus*.
 Leibniz, *Philosophical Papers and Letter to Varignon*.
 Lyndon H. LaRouche, Jr., *The Science of Christian Economy, and Other Prison Writings* (Washington, D.C.: Schiller Institute, 1991).
 David Shavin, "Courage of Gauss," unpublished manuscript, 2005.
 Leonard Euler, *Letters to a German Princess* (New York: Thoemmes Continuum, 1997).

FIGURE 5



How does one point, then, differ from another point? Now, draw a perfect point, a point which pertains to nothing of length, area, or space. You will never succeed in making it small enough to be an actual point within an actual geometry. You must attack the idea of a point in an entirely different way than the poor, rattled Euler tried but failed to accomplish; you must appreciate its existence as that of a *singularity of a physical geometry*, a point which poor Euler missed entirely.

To refresh our discussion of this general type of problem, as we considered this in the preceding chapter of this report, the definition of a point within the framework of a formal Euclidean geometry, is self-evidently an absurdity comparable to the silliness of the general systemic features of the arbitrarily adopted rectilinear scheme which is the central characteristic of the formal Euclidean system.

Ah, as I had often cautioned my associates in the time I

used to teach classes in economics at sundry campus and kindred locations: if you are walking along a woodland path, and find a strange object in the pathway, carefully probe it with a stick, and see what it does. To come to the point of this discussion: *The meaning of a point is what it does. The entirety of the working notion of a complex domain hangs upon that warning.* Points can not be measured as displacements; they are known only by what they can be provoked into doing.

That presents us with a traditional problem of axiomatics. Is a point a degree of smallness, or does it correspond, in the case at hand, to one among numerous, alternative distinct physical species of existence? It is not the axiomatically shrunken line which Euclid, in a silly moment, argued it to be. It is, ontologically, epistemologically, *a discontinuity in the assumed universe of the naive view of human sense-perception.* Any real point is an occurrence which is laughing at the

Box 18

Einstein-Born Dispute

The 2,500-year-old fight between the method of the science of *Sphaerics* and the Aristotelean fraud represented by Euclidean geometry, is reflected during the 20th Century in the fight between Albert Einstein, Max Planck et al., and the culturally pessimistic irrationalism typified by Niels Bohr's so-called Copenhagen interpretation of quantum phenomena.

This fight has its immediate origin at the end of the 19th Century, when scientists were confronting a growing body of experimental evidence, such as the photoelectric effect and Planck's discovery of the quantization of light and heat, that indicated that the characteristics of physical action in the microscopic domain are fundamentally different from the macroscopic domain of every day experience. These experimental discoveries were consistent with the earlier work of Carl Gauss, Augustin Fresnel, Bernhard Riemann, Wilhelm Weber, et al. who, having extended G.W. Leibniz's method of the infinitesimal calculus, had begun the investigation of the characteristics of microscopic principles from their experimentally observed macroscopic effects. These

Leibnizians understood that the characteristics of the very small, reflected *universal* principles, and thus, can only be considered with respect to the universe as a whole.

These investigations of Gauss, et al. had led Riemann, in his habilitation dissertation of 1854, to insist that it was scientifically unsound to assume that the characteristics of physical action observed in the macroscopic domain could be linearly extended into the very large and very small. Instead, Riemann insisted, science must develop a dynamic notion of physical geometry that reflected the potential for non-linear change between these domains of action.

As Riemann stated: "Knowledge of the causal connection of phenomena is based essentially upon the precision with which we follow them down into the infinitely small. . . . In the natural sciences, however, where simple fundamental concepts are still lacking for such syntheses, one pursues phenomenon into the spatially small, in order to perceive causal connections, just as far as the microscope permits. Questions concerning spatial relations of measure in the indefinitely small are therefore not useless."



N.Y. Public Library

Carl F. Gauss (1777-1855). His 1799 attack on reductionism reflected the ancient quarrel between the followers of Plato and of Aristotle.

In reaction to Riemann, the British-centered empiricists desperately tried to revive the Aristotelean methods of Kant and Euclid, typified by the work of James Clerk Maxwell, who famously rejected Riemann's approach to physics, in favor of the neo-Euclidean doctrine which excluded "any geometries other than our own." Thus, when the relationship between the observed macroscopic effects of electromagnetism were considered in light of the growing body of experimental evidence indicating a

dupes of Euclidean geometry, from outside the bounds of a naive faith in the self-evidence of mere sense-perception. De Moivre and D’Alembert, followed by Euler, who was followed by Lambert, Lagrange, et al., thought they had concealed their ignorance of the subject of the point, by calling any points which happened to turn up “imaginary.” What they sought, thus, to conceal, were the restrictions imposed upon human behavior by the universe in which we exist.

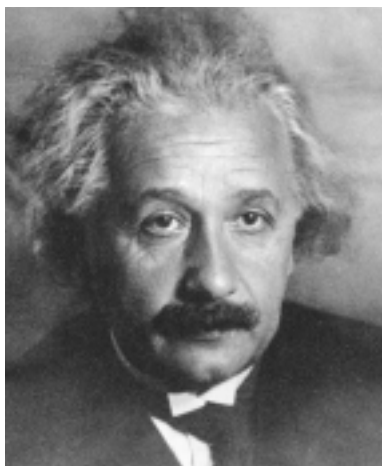
The belief in a Euclidean “point” must therefore be an obsession best suited to the confines of pointed human heads! It is exactly that obsession, a nothing swallowed whole by credulous students of Euclidean and kindred geometry, which comes to the surface as the hidden target which is the victim struck repeatedly by Gauss’s relentlessly thorough attacks in his 1799 dissertation.

Putting this nothing of importance aside for a moment, rec-

ognize the efficient reality, that these principles which the empiricist ideologues have associated with nothing more than an empty point, have been shown to be very efficient principles, powers in the sense of the Pythagoreans, Plato, Cusa, Kepler, Fermat, and Leibniz, for example.

Einstein’s Point

Therefore, to avoid the trap of thinking about nothing but nothing, look at the “*universe*,” instead of some assumed “point” of nothingness. What does the word “universe” mean in practice? What should it mean? What did it mean to Albert Einstein, for example, as opposed to the increasingly decadent opinion of his increasingly misled old friend Max Born, for example? *To discover what is very, very small, we must turn our attention to the very, very large: the universe as a unit of existence.* (See **Box 18.**)



Library of Congress

Albert Einstein (1879-1955). His notion of a “finite but unbounded universe,” approximated a Riemannian conception of a finitely self-bounded universe.

change in physical characteristic in the microscopic domain, Riemann’s guidance proved to be essential.

Statistical Methods Creep In

In confronting the paradoxes presented by the experimental evidence of quantum phenomena, Einstein, Planck, and their collaborators, relied on Riemann’s guidance. However, among Einstein’s contemporaries, it became increasingly popular to avoid a confrontation with the assumptions of Euclideanism by “explaining” these

quantum phenomena by statistical methods, similar to those used by Ptolemy, Copernicus, and Brahe. These efforts were led by Niels Bohr, his protégé Werner Heisenberg, and Heisenberg’s first teacher, Max Born.

Born had been an early collaborator with Einstein, developing some of the earliest elaborations of Einstein’s special theory of relativity. In 1912, he joined Einstein and Planck at the University of Berlin, where he developed a close friendship with both. But, in 1921 Born returned to Göttingen University, where he began work on statistical mechanics. In 1926, in collaboration with his students Werner Heisenberg and Wolfgang Pauli, Born formulated a statistical approach to physics using matrix algebra, which he called “quantum mechanics.”

Born’s quantum mechanics was a mathematical formulation of Bohr’s interpretation of quantum phenomena, which depended on considering quantum phenomena as isolated from the universe as a whole. So isolated, the quantum effects appeared to be erratic and were not susceptible to being described by a simple mathematical expression. As such, Born, Bohr, Heisenberg, et al., relied on statistical probability matrices to describe quantum phenomena as the most probable result of a fundamentally random interaction, occurring in an empty



Max Born (1882-1970) was an early collaborator of Einstein, but sank into the swamp of “quantum mechanics.”

Euclidean-type space. Born went still further, declaring that his matrix algebra was not merely a compromise attempt to describe the observed effects, but that it was an accurate reflection of the nature of the physical universe itself.

However, this so-called Copenhagen interpretation of quantum phenomena was not a serious scientific concept. Like Ptolemy’s earlier sophistical attack on the Greek science of *Sphaerics*, the Copenhagen interpretation was an oligarchical-led attack on the method of

Box 18 continues on next page

What did Einstein mean by stating that the universe is *finite but unbounded*? What do I mean by insisting that the expression should have been *finite and self-bounded*? Answer all such questions from the vantage-point of *Sphaerics*.

Look at the starry universe as Kepler did. It is provable that the common error shared among Claudius Ptolemy, Copernicus, and Tycho Brahe, was a result of the implanting of the variety of sophistry practiced by Aristotle against the earlier, competent scientific method of such as the Pythagoreans and Plato. The experimental method of Kepler was, like that of Nicholas of Cusa, Luca Pacioli, Napier, Kepler, William Gilbert (*De Magnete*), and Fermat, a revival of the legacy of *Sphaerics*.

As I had insisted already decades ago, the spoor of the rise of historical civilization out of the immediate aftermath of the last prolonged glaciation in the northern Hemisphere,

could only have occurred through a leading role by a transoceanic maritime culture, rather than from inland developments preceding major ancient riparian cultures of known history. This is to be seen in Mexico's archeology, where the maritime culture is represented, as it was to my own eyes, in the relatively oldest of the famous, relevant inland sites. It is reflected in the oldest of the Greek sites, which are cities of a maritime culture fortified against attacks from inland-dwelling barbarians. It is shown in some of the studies of ancient calendars which were incorporated in Bal Gangadhar Tilak's *Orion and Arctic Home in the Vedas*. The case of ancient historical Egypt is crucial, in which the characteristics of the great pyramids mark the legacy of a transoceanic maritime culture, as this is otherwise indicated by the attribution of the method of *Sphaerics* to Egyptian origins by the Pythagoreans and others.

Leibniz, Gauss, Riemann, et al., driven by the cultural pessimism that had come to prevail at the turn of the century. Like their predecessor Ptolemy, Bohr, Heisenberg, and Born et al. argued that since no mathematical formulas other than statistical methods had been found to describe physical phenomena, no physical principles existed other than their statistical formalism. Because no principles existed, none could be discovered.

Einstein stubbornly resisted this descent into irrationality, and along with Planck, vociferously defended causality in science throughout his life. However, Born, although initially an ally of Einstein and Planck, succumbed to the cultural pessimism that spread throughout Europe in the wake of World War I, and his earlier collaborative relationship with Einstein turned into an intellectually adversarial one. Nevertheless, the two men continued to exchange letters until Einstein's death in 1955. That exchange of letters provides a clear insight into these two opposing views of science.

Born summarized his view of the dispute in the published collection of his correspondence with Einstein:

"The basic reason for the dispute between us on the validity of statistical laws was as follows. Einstein was firmly convinced that physics can supply us with knowledge of the objectively existing world. Together with many other

physicists I have been gradually converted, as a result of experiences in the field of atomic quantum phenomena, to the point of view that this is not so. At any given moment, our knowledge of the objective world is only a crude approximation from which, by applying certain rules such as the probability laws of quantum mechanics, we can predict unknown (e.g. future) conditions."

In September 1926, after reviewing Born's statistical work on quantum mechanics, Einstein stated his view clearly in a letter to Born:

"Quantum mechanics is certainly imposing. But an inner voice tells me that it is not yet the real thing. The theory says a lot, but does not really bring us any closer to the secret of the 'old one.' I, at any rate, am convinced that *He* is not playing at dice. Waves in 3-dimensional space, whose velocity is regulated by potential energy (for example, rubber bands) . . . I am working very hard at deducing the equations of motion of material points regarded as singularities, given the differential equation of general relativity."

God Doesn't Play Dice

Writing to Born years later, in September 1944, Einstein summed up the view he had continued to express:

"We have become Antipodean in our scientific expectations. You believe in the God who plays dice, and I in com-

plete law and order in a world which objectively exists, and which I, in a wildly speculative way am trying to capture. I firmly *believe*, but I hope that someone will discover a more realistic way, or rather a more tangible basis than it has been my lot to find. Even the great initial success of the quantum theory does not make me believe in the fundamental dice-game, although I am well aware that our younger colleagues interpret this as a consequence of senility. No doubt the day will come when we will see whose instinctive attitude was the correct one."

In September 1950, after his association with Kurt Gödel had improved his historical and epistemological knowledge, Einstein wrote Born saying:

"I see from the last paragraph of your letter that you, too, take the quantum theoretical description as incomplete (referring to an ensemble). But you are after all convinced that no (complete) laws exist for a complete description, according to the positivistic maxim *esse est percipi*. Well, this is a programmatic attitude, not knowledge. This is where our attitudes really differ. For the time being, I am alone in my views as Leibniz was with respect to the absolute space of Newton's theory. There now, I've paraded my old hobby-horse once again. But it is your own fault, because you provoked me."

—Bruce Director

As I have emphasized in other published locations, the Euclidean system of rectilinear axiomatics is a product of the Babylonian priesthood's influence penetrating Greek culture through, most prominently, the Delphi Apollo cult of sophistry. The teaching of plane geometry from the vantage-point of Euclidean assumptions reveals its origins when we recognize that the Euclidean system is axiomatically an inherently "flat Earth" system, as Abraham Kästner emphasized this fact in defining an anti-Euclidean geometry in which young Gauss was experienced, and which came fully into its own with Riemann's 1854 habilitation dissertation.

The obvious way for a layman to approach the subject of astronomy, as the work of Kepler emphasizes, is to treat the night-time sky, or a day-time sky viewed from a deep pit in a dry climate, as a spherical domain of Earth-based perceptions. No axiomatic assumptions are made, except those empirically implicit in the action of observation. Map ostensibly regular and other, special cases, such as eclipses as by Thales, Aristarchus, and others, or Kepler's alignment of Sun, Earth, and Mars, and compare this with the compilations of astronomical evidence from Vedic calendars by Tilak. Astronomy, as passed down to the present in such ancient times, is based on the ironies of change, defined by reference to singularities, within regularity. *Nothing, then, is constant, except change.*

How large is the ostensibly, and possibly spheroidal universe so observed? Simple observation does not provide an answer. A different way of thinking about those observations provides us a hint as to what we should intend to signify by raising the question of "How big is the universe?" My answer is, that the universe is finite, but also self-bounded.

The theological implications of that point of physical science are fascinating. A finite and self-bounded universe which contains the efficient existence of human creativity within it, defines the universe as the expression of a willful Creator with the attributes of what we may identify as creativity in a human individual, "The Boss," who is capable of limiting his or her opinion to what may be described as scientifically truthful, but who is able, and inclined to create new states of the universe at will.

Therefore, I pose no absolute objection to Einstein's use of "unbounded," if we are speaking of the absence of any limits imposed upon the Creator's will. I merely insist that we must focus on the fact that the universe as it exists at any time, is *then* self-bounded. From the standpoint of human sense-perception's relevance, we draw our sense-perceptual opinion about this universe as being a spherical one *in some sense*, that simply because we have yet no compelling reason of evidence to think otherwise.

Therefore, become for a moment an ancient transoceanic traveller in the image of Tilak's accounts in his *Orion and Arctic Home in the Vedas*. Think of that kind of traveller's

experience, over many thousands of years of accumulated experience, in navigating the seas by aid of stars, Sun, Moon, and experiencing the cyclical changes in the magnetic compass's registration of the North magnetic pole. Think of the increased number of singularities appearing in the cumulative record of developments which had formerly seemed to have been fateful regularities. See the importance of the discovery of the Zodiac in enabling ancient sea-going cultures to bring a sense of order among the seeming regularities and well-marked singularities of their cumulative experience, as Tilak's European and other sources on the subject of traces of ancient astronomy attest for perhaps hundreds of thousands of years of development of relevant types of human culture.

At this point, our conception of the universe becomes explicitly Riemannian. The theological and cultural phenomena I have just summarized in the foregoing way, belong to a quality of hypergeometry which is specifically Riemannian, especially so when the role of what Riemann identifies as "Dirichlet's Principle" is taken into account. *Riemann's use of "Dirichlet's Principle" implicitly defines the epistemological basis for the mathematical physics of a finite but self-bounded universe.*

What bounds the universe is the dynamically interacting array of universal physical principles. Taking that into account, how might we expect to find a universal physical principle as an object of experience, an object recognized as such in the circumstance in which its effect is relevant to the situation we are considering? What form, as an object, does that principle assume in that setting?

The answer? *Try a point.*

At that point, how can we determine which universal principle, such as universal gravitation, is operating? The principle is, as Kepler emphasizes, acting efficiently at every imaginably small interval, and yet smaller. It is expressed, thus, as a true principle, a highly efficient apparent *nothing*, which we recognize as *a perfect singularity*.

There we might recognize the nature of Euler's wild-eyed hysteria on the matter of the "smallness of points," when a point is to be recognized as expressing a true singularity. It is an object which can not be perceived directly, precisely because it is efficiently universal, as the act of doubling a cube by construction is an expressed universal. What you can perceive is the way in which it acts upon the relevant set of phenomena. It appears mathematically in the form of the complex domain.

Take Leibniz's universal principle of physical least action. How does this appear as an efficient nothing? It has the characteristic of the catenary curvature, which is a well-defined curvature in the language of the complex domain. This function is also what Leibniz defined as the characteristic curvature of the natural logarithmic function. Such "nothings," which are always associated with

Box 19

The Catenary

“The resourcefulness of this curve is only equal to the simplicity of its construction, which makes it the primary one among all the transcendental curves.”

—G.W. Leibniz, *On the Catenary Curve*, 1691

Leibniz, knowing the order of the universe to be developing in accordance with perfection, by which the simplicity of its means carries out the richest accomplishments, sought to bring the state of mankind into coherence with the discoverable reality of such a universe.

The simplicity of its means shines forth in Leibniz’s investigation of the catenary, a curve he defined as expressing “least action.” This curve hangs the universe in perfect suspension amongst every infinitesimal point, and thus, most simply expresses the pathway of gravity’s ordering of the material world. The catenary’s productivity exceeds all other curves, in its power to generate all algebraic powers from itself, thus truly demonstrating the power to accomplish the richest effect.

The constantly changing nature best expresses Leibniz’s calculus, in which all matter and motion is constantly guided, not through sense perception, or connecting dots and determining algebraic equations, but through a set of unseen relationships demanding themselves to be maintained throughout, as in a curve changing its pathway, thus pointing to an unseen physical principle existing universally throughout the curve. These principles, reflected as a guiding relationship, exist at even the smallest interval of change, as along the catenary, where least action is maintained even at the point the empiricists call nothing, or zero: the point at the exact bottom of the chain.

Thus Leibniz, leaving the world of

changeless chaos of sense perception to the beasts, solved a seemingly unsolvable paradox of sense perception, in which a constantly changing universe, such as a pathway of constant curvature, can be known through paradoxical infinitesimally small points, which are the most simple, but also have the most power. Therefore, in discovering the reason for the catenary curve, opening up a whole new realm of science, Leibniz experimentally demonstrated to mankind that the universe is one of a perfect Creator, one designed for the human mind to discover its eternal truths. Even while he was often occupied with “responsibilities of a totally different nature,” that is, launching a global political renaissance reaching the shores of North America and extending as far as China, Leibniz saw that improving the method by which humanity could discover principles and apply them to further increase the perfection and power of the human mind, results in profound developments for the human species as a whole, and thus is the only means to change the state of mankind. This is the power of the catenary.

Catenary Curvature

“The first to consider this curve, which is formed by a free-hanging string, or better, by a thin inelastic chain, was Galileo. He, however, did not fathom its nature; on the contrary, he asserted that it is a parabola, which it certainly is not. Joachim Jungius discovered that it is not a parabola, as Leibniz remarked, through calculation and his many experiments. However, he did not indicate the correct curve for the catenary. The solution to this important problem therefore remained for our time.”

—Johann Bernoulli, *Lectures on the Integral Calculus*, 1691

FIGURE 1



The catenary is the curve formed by a hanging chain, whose constantly non-constant curvature is acted on by the pull of gravity, and horizontal tension. Its changing vertical/horizontal relationship can only be determined physically, by these two forces, and cannot be expressed algebraically in any Cartesian coordinate system. Is the one power determining the interaction of these forces knowable?

Hang a chain between your hands. Keeping the chain in one place, have someone else pinch a lower portion of the chain. Let go of the extra chain! Does it change its structure? No. The total weight between your hands changes, but not the

FIGURE 2

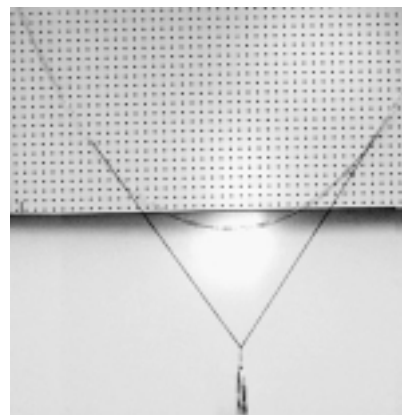


FIGURE 3

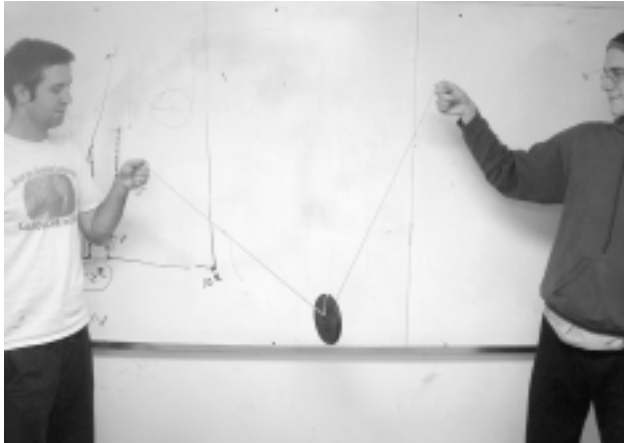
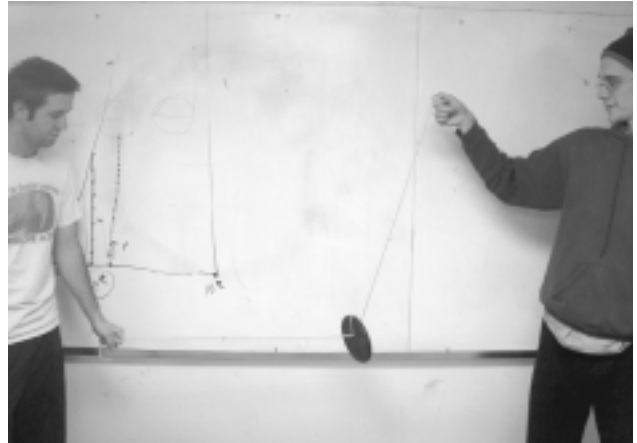


FIGURE 4



structure of the chain. Although the vertical force increases as the amount of chain increases, the horizontal force stays constant; this can be discovered by finding the horizontal force at the bottom of the catenary and observing the effect as you remove lengths of chain. Does the horizontal force change (Figure 1)?

The constant horizontal tension and the vertical force of gravity have an unseen, changing relationship as you change the position of your hands on the chain. To find out how these forces determine the curve, it is necessary to use more than the senses.

Therefore, proceeding to the unseen, remove a portion of chain and replace it with a weight hanging tangent to the curve. What do you observe? If your measurements are correct, the links holding up the weight, equal to the chain removed, do not move, nor do they notice the change. Therefore, because the weight of chain exerts its action at the tangent points and the pull of the weight is equal, whether you have the catenary or a proportionate amount of weight hanging at the intersection of the tangents, the unseen relation of vertical and horizontal force acting to determine the curvature of the chain, can now be discovered and measured precisely, using this method of tangents (Figure 2).

Now, hang a weight on a rope. If it is not swinging from side to side, it is clear that the horizontal tension is constant,

while the vertical force on either part of the rope changes as the angles change (Figure 3).

Hold the weight still, and rotate one of the ropes perpendicular to the pull of gravity (Figure 4).

At this moment of the experiment, a singularity of the physical relationships arises: The force pulling on that end of the rope is horizontal only, with no vertical component. At only this singular point, the relationship between the constant horizontal force and the force of the vertical weight pulling down is found to correspond with the ratio of the sines of the two angles α and β , which correspond with the vertical and horizontal lengths X and Y (Figure 5).

Since the chain, or the weight hanging on the tangents, has an equal effect on the tangent links, the relation of the whole weight E to the horizontal force at B can similarly be expressed as the relation of the whole chain AB to the length of chain a shown in Figure 1, whose weight is equal to the horizontal force at bottom. Therefore, the vertical and horizontal change expressed as length X and length Y can be expressed in a proportionate relationship with length AB and a . $X/Y = AB/a$.

In other words, the relationship of forces is transformed back into the relationship corresponding to our original length of the catenary chain, and therefore, the physical forces are discovered to be proportion-

al to the vertical/horizontal change.

But, is this relationship constant throughout the chain? Using the method of Leibniz's calculus, an infinitesimally small change of the tangent will result in an infinitesimally small change in X and Y , expressing the same relationship. Therefore, the relationship of the two forces is precisely proportionate to the change of X and Y at every point; in other words, an infinitesimally small point expresses the relationship guiding the whole curve.

The unseen physical characteristic is brought into view by way of a single "point." This point does what no other

FIGURE 5

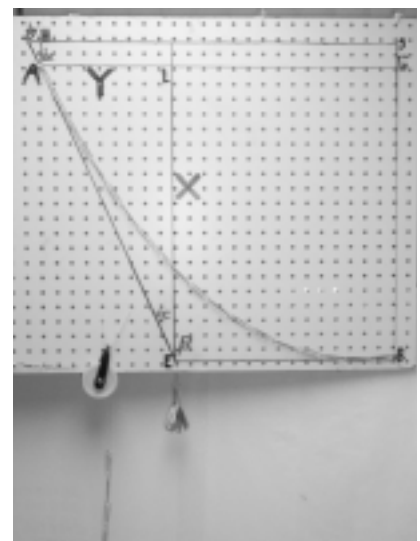
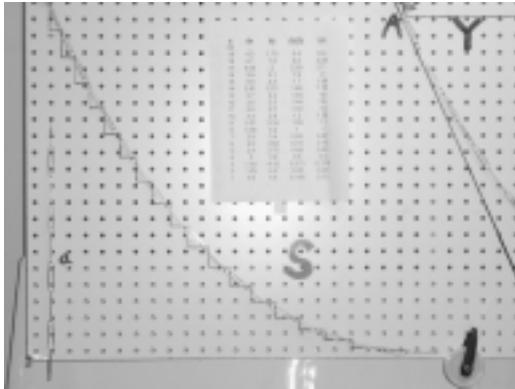


FIGURE 6



S	X	Y	S/a	X/a
20	-	-	-	-
19	4.2	1.75	2.4	2.4
18	4.1	1.9	2.2	2.25
17	4.05	2	2.05	2.1
16	3.9	2.1	1.9	2
15	3.8	2.2	1.7	1.88
14	3.81	2.31	1.65	1.75
13	3.7	2.4	1.54	1.6
12	3.6	2.5	1.44	1.5
11	3.6	2.7	1.33	1.3
10	3.4	2.8	1.2	1.25
9	3.27	3.16	1.03	1.1
8	3.08	3.2	1	1
7	2.9	3.4	0.85	0.87
6	2.8	3.62	0.72	0.75
5	2.4	3.75	0.64	0.63
4	2	3.9	0.5	0.5
3	1.55	4.15	0.373	0.375
2	1.25	4.2	0.29	0.25
1	0.6	4.4	0.136	0.13

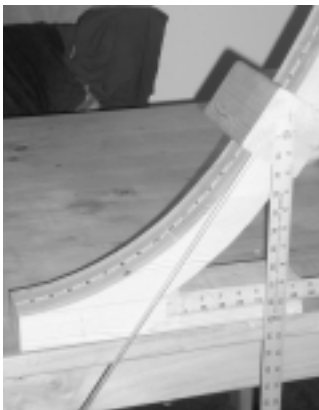
point on the catenary does. Acting as a true singularity of *physical* geometry, it most clearly expresses the unseen physical power ordering the curvature of the catenary.

Figure 6 demonstrates this discovery for 20 points of tangency, where S is

taken as different lengths of the catenary and a is the constant equal to 8 paperclips. Here, in looking at the data, observe the relationship that exists even while the parameters are changing constantly. Hypothesize what relationship is demanding itself to be maintained,

FIGURE 7

S	X	Y	S/a	X/a	X ² /a ²	Diff.
20.00	2.03	31.37	2.54	2.54	6.45	12
19.00	2.50	26.87	2.42	2.42	5.86	15
18.00	2.75	24.44	2.37	2.37	5.62	16
17.00	2.88	23	2.3	2.3	5.29	13
16.00	2.96	21.5	2.2	2.2	4.84	15
15.00	2.98	19.96	2.11	2.11	4.45	13
14.00	2.95	18.34	2.1	2.1	4.41	12
13.00	2.7	16.79	2.1	2.1	4.41	12
12.00	2.3	15.24	2.1	2.1	4.41	12
11.00	2.26	13.69	2.1	2.1	4.41	12
10.00	2.2	12.14	2.1	2.1	4.41	12
9.00	2.1	10.59	2.1	2.1	4.41	12
8.00	2.05	9.04	2.1	2.1	4.41	12
7.00	2.0	7.49	2.1	2.1	4.41	12
6.00	1.95	5.94	2.1	2.1	4.41	12
5.00	1.9	4.39	2.1	2.1	4.41	12
4.00	1.85	2.84	2.1	2.1	4.41	12
3.00	1.8	1.29	2.1	2.1	4.41	12
2.00	1.75	-0.26	2.1	2.1	4.41	12
1.00	1.7	-1.81	2.1	2.1	4.41	12
0.00	1.65	-3.36	2.1	2.1	4.41	12
-1.00	1.6	-4.91	2.1	2.1	4.41	12
-2.00	1.55	-6.46	2.1	2.1	4.41	12
-3.00	1.5	-8.01	2.1	2.1	4.41	12
-4.00	1.45	-9.56	2.1	2.1	4.41	12
-5.00	1.4	-11.11	2.1	2.1	4.41	12
-6.00	1.35	-12.66	2.1	2.1	4.41	12
-7.00	1.3	-14.21	2.1	2.1	4.41	12
-8.00	1.25	-15.76	2.1	2.1	4.41	12
-9.00	1.2	-17.31	2.1	2.1	4.41	12
-10.00	1.15	-18.86	2.1	2.1	4.41	12
-11.00	1.1	-20.41	2.1	2.1	4.41	12
-12.00	1.05	-21.96	2.1	2.1	4.41	12
-13.00	1.0	-23.51	2.1	2.1	4.41	12
-14.00	0.95	-25.06	2.1	2.1	4.41	12
-15.00	0.9	-26.61	2.1	2.1	4.41	12
-16.00	0.85	-28.16	2.1	2.1	4.41	12
-17.00	0.8	-29.71	2.1	2.1	4.41	12
-18.00	0.75	-31.26	2.1	2.1	4.41	12
-19.00	0.7	-32.81	2.1	2.1	4.41	12
-20.00	0.65	-34.36	2.1	2.1	4.41	12



although showing up as changing in each differential expression. Can this be known in any other way but through its physical relationship?

To animate this new idea even further, examining these physical forces solely as changing lengths, a proof of the principle using a machine tool was constructed to continuously demonstrate the differential expression $S/a = dx/dy$. The measurements taken are shown in Figure 7.

Natural-Logarithmic Function

To repeat what was said above, the catenary curve cannot be known from any algebraic function. Leibniz, seeking for a “type of expression, as well as the best of all possible constructions, for transcendentals” was led toward a “higher domain for which new avenues needed to be opened.” He found the catenary to be constructible as the arithmetic mean between two logarithmic curves, one constructed inversely to the other. Thus the catenary is a function of two non-algebraic functions (Figure 8).

What physical construction are these two inverse logarithmic curves derived from?

Try a doubled cone of 90° cut perpendicular to the base. This creates a hyperbola (Figure 9).

Looking back at Bernoulli’s lectures on integration, one sees that he demonstrates that the hyperbola grows in area arithmetically, while the lengths grow geometrically. Hence, he constructs the essence of the equilateral hyperbola: the natural logarithmic curve, a curve of arithmetic growth in one direction and geometric growth in the other, with a subtangent of 1 (Figure 10).

Now, return to the double cone and construct a logarithmic curve from the curves of the hyperbola on either side. Are these the two curves that Leibniz uses to construct the catenary? How can we replicate his construction with our two invisible logarithmic curves on opposite sides of the cone? What is required to bring these curves into an inverse relationship (Figure 11)?

To construct the relationship of the natural logarithmic curves that Leibniz designed, one curve must swing around the zero point on the axis, i.e., the vertex of the double cone. By what amount? An

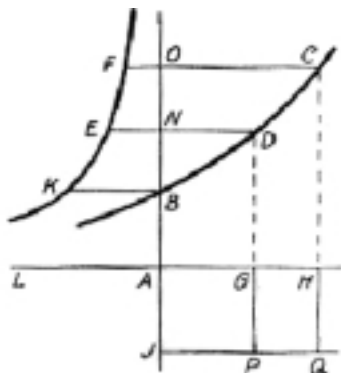
FIGURE 8



FIGURE 9



FIGURE 10



“imaginary” one! (Figure 12)

Thus is found Leibniz’s construction, in a new domain, existing paradoxically from the standpoint of the sense-perceived cone. As Leibniz proclaimed: “[T]he Divine Spirit found a sublime outlet in that wonder of analysis, that portent of the ideal world, the amphibian between being and not being, which we call the imaginary root of negative unity.”

How did Leibniz discover this?

FIGURE 11

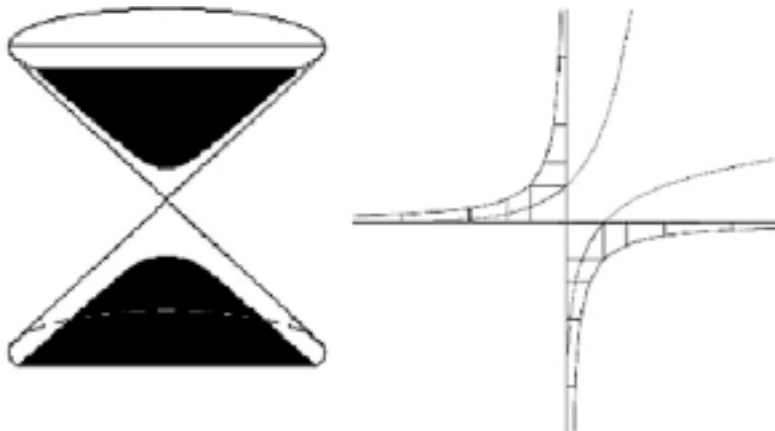
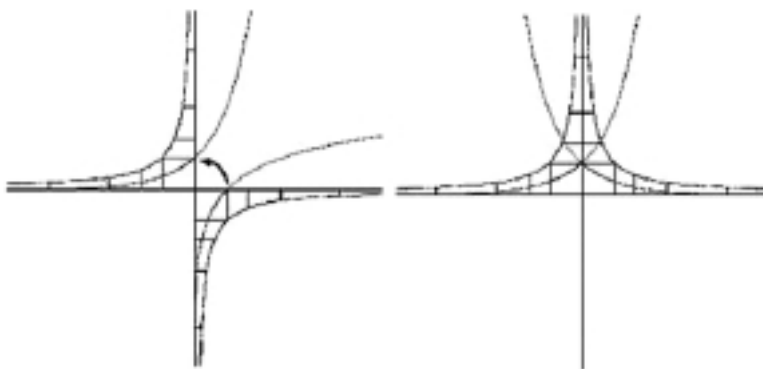


FIGURE 12



Investigate this construction more closely. What is the geometric mean between the two logarithmic functions? Well, the height of the logarithmic curve below the catenary is to the height of one, as one is to the height of the logarithmic curve above the catenary. In other words, the geometric mean is the tangent to the point at the bottom of the catenary, which is, ironically, the point betraying the unseen *physical* power generating the curvature of the catenary (Figure 8).

“Even though my hands were tied,” Leibniz wrote in 1691, “and I could not busy myself with this as I should have, there was a higher domain for which new avenues needed to be opened; so, this is what was important in my eyes: That is, the case of developing methods is always more crucial, than particular problems, although it is the latter which usually bring applause.”

—Michael Kirsch and Aaron Yule

The discovery of more and more among those apparent nothings which actually control the universe's behavior, proves, conclusively, that sense-perception is as the Apostle Paul writes in *I Corinthians* 13, a reflection of reality in a murky mirror. The world of so-called "sense certainty" is not the actual universe in which we exist, but a kind of shadow of that universe, which lurks beyond sense-perception, within the real universe which the sovereign cognitive powers of the individual human mind are able to discover, as within the complex domain which reductionist fools call "imaginary," and to employ efficiently to change the shadow-universe of sense-perception, by acting to change the reality which is reflected in our powers of sense-perception.

The case of the doubling of Archytas' cube, thus serves as the entry-point into the larger complex domain which is the universe which lies hidden behind what is apparently the absolutely nothing called a "point."

That is the universe which Leibniz recognized as being "the best of all possible worlds."

That is Gauss's *Power*.

3. Vernadsky's Contribution

In my "Vernadsky and Dirichlet's Principle," I pointed out those characteristic features of V.I. Vernadsky's presentations of the Biosphere and Noösphere, which compel us to radically redefine the notions of political-economy to conform with the import of that evidence.⁹ As I had already done since 1953, I defined the productive powers of labor in terms of *physical output per capita of total production of a society per capita and per square kilometer*. This approach included emphasis on the functional relationship of the categorical components of the total throughput, with principal emphasis on the crucial distinction between *basic economic infrastructure, which defines the physical state of an area*, and *production which fits within the set of relationships characteristic of the so-called "private sector."* The standard which I adopted for this process was *potential relative population-density*. I have employed those standards, adopted then, to the present day. Now, recently, the implications of Vernadsky's discoveries have been appropriately assimilated into my original design launched in 1953.

When we take into account what must be today's relevant appreciation of the physical-economic implications of Vernadsky's indicated contributions to the concepts of Biosphere and Noösphere, a critically significant improvement in our ability to treat an economy as a social process comes into play. This improvement is not only an advantage

which Twentieth-Century developments in physical science had made accessible to an appropriate mode of practice; the combined rate of throughput and size of today's world population, make these refinements necessary for looking at the kind of economy we must have beyond the next two generations of a quarter-century, each, ahead.

I shall not repeat here the full scope of what I have already addressed in "Vernadsky and Dirichlet's Principle." That writing exists in print, and may be treated as integral to the argument set forth here. There are, however, certain conclusions which are only implicit in what I wrote for a different purpose, there. In today's world, we must take into account those special considerations which are of indispensable importance for any program capable of rescuing mankind from the mess which has been made of this planet as a whole, a mess building up during the recent four decades of drift toward the species of "Hell hole" which a "globalized," "post-industrial," "free trade" society would represent.

For the broad reasons to which I have just pointed, the recent changes in the character of the world situation as a whole, require that we now scrap all the generally accepted teachings in use by most governments, to understand the dynamic relations which actually underlie the feasibility of organizing a sustainable rescue of the planet from the awful mess we are making of it today. The significance of my report on that aspect of the matter of Vernadsky's discoveries, and the relationship of that to the topics addressed in the preceding chapters, will be clarified, with aid of some necessary interpolations, as we proceed in this chapter of the report as a whole.

To answer the questions which are implied in the notions of Biosphere and Noösphere, define man's physical-economic relationship to his environment according to four classifications of universal physical principles, principles which correspond to types of approximate phases within the conditions associated with that relationship. Bear in mind as we consider these four kinds of conditions on Earth on which we shall focus in this chapter, the comparable ideas which come to mind when we consider the challenge of approximate "Earth-forming" on some locality designated for human activity on Mars, or, in the more distant future, the possibility of "Earth-forming" in the presently atrocious state of affairs on the nearly Earth-sized Saturn moon of Titan. We must employ the general conception of "Earth-forming" which those cases imply, to impress upon us the importance of applying that thus-generalized concept of "Earth-forming" to our immediate situation here on Earth.

Meanwhile, back on Earth: we do not yet know enough of what we need to know about what the human system will tolerate in our stretching the environmental conditions of life toward some point beyond what might be the limits of toleration. However, in the meantime, we can let such speculative

9. Lyndon H. LaRouche, Jr., "Vernadsky and Dirichlet's Principle," *EIR*, June 3, 2005.



Vladimir I. Vernadsky (1863-1945). His definition of the Biosphere and Noösphere, provides the point of departure for successful new modes of physical-economic management.

questions about needed conditions for human life in visiting other planets, assist us, in improving the way we think about the conditions required on Earth for not only the bare existence, but also the productive requirements of an increasing human population. Thinking about such things, sharpens the focus of our attention to relatively much more modest challenges than interplanetary prospects, the immediately important ways of thinking about the economic relationship of man to the way his environment might be developed, or lack development. Call it, if you will, "Terra-Forming of The Planet Earth." Nothing less dramatic than that, is implicit in the challenge presented to us when we give adequate consideration to the referenced discoveries of Vernadsky.

The four indicated states of man's relationship to environment, are approximately the following. Each among all the first three of these states, is defined by a state of organization among the elements of that category which are governed by an ordering-principle which is not one among those elements, but which is a principle subsuming the organized, interdependent existence of all of those subject elements. Each of these three, relatively lower states, is defined by a subsuming principle of experiment which assumes the existence of the condition of the characteristic of the elements of that state.

The notion of subsuming principle is, admittedly, strange to those who have been behaviorally conditioned to surrender their minds to the reductionist conceits of deductive/inductive method. Each of the states which I have indicated is not statistically implicit in the set of terms subsumed; rather, it is defined by the efficient manifestation of a singularity which represents an exception to any possible inductive assessment of the principle which defines that phase as distinct from the others. It is a universal physical principle whose authority is superimposed upon the array of relevant data, rather than being a formally consistent, mechanical sort of expression of the action within that domain,

The lowest of these states, represents materials which the relevant principle of experimental design assumes to have been generated as non-living in origin. As Vernadsky emphasizes in my citations from his work, living processes take materials, selectively, from the abiotic domain, process them in ways which do not occur normally within the abiotic domain, and ultimately will have spewed virtually all of the products of the earlier phases of this living process back into the abiotic domain.¹⁰ Thus, we mine minerals we require chiefly from the Biosphere's concentrations left behind as excretions or sediments of living processes. This constitutes the Biosphere. Although chemical elements "recycled" in this way, came from the abiotic domain, they now exist in an altered form of existence, no longer part of the pre-biotic domain, but as integral features (i.e., fossils) of the Biosphere, with characteristics which are an expression of that history.

What is, is what is produced as the result of the proximately preceding process. Without taking that "history" into account, any definition is an error of recklessness by virtue of omission. So, you, too, are an expression of your ancestry, and of the process of development of that ancestry's culture.

Thus, the next highest rank of state, the second rank, the Biosphere of Vernadsky, is that of living processes and their fossils.

The still next higher state, that specific in origin to human cognitive processes and its fossils, is the state which Vernadsky classed as the Noösphere.

The fourth domain, is the unifying principle which subsumes the existence of mankind as a class of creative beings, and which orders both the existing potentialities of that class of beings, and its specific fossils.

The class expressed by each state, and relations among the respective states, is treated as organized by both the powers characteristic of that domain, as I have defined powers in the preceding chapters of this report; and, the powers acting upon it from the higher domain, including, of

10. Op. cit.

course, what I have designated as the Fourth Domain. The interplay of these *powers*, within, and among their respective states, is, as Vernadsky specified for the Biosphere, *dynamic*, rather than mechanical (e.g., rather than Cartesian, Newtonian, or Euclidean).¹¹

To illustrate what I have just written here, consider the following illustrative sampling from the recent physical-economic history of the U.S.A.

See How the U.S.A. Has Decayed!

During the recent year, my association has been producing animated summaries of available, county by county physical-economic data, on key changes in the physical conditions of the area of the U.S.A. Computer animation of relevant samples of this data, has been presented on various public website locations, public addresses, and in reporting directly to particular relevant officials and others. Although some longer-term studies of this sort have been published so far, attention has been concentrated on the accelerating decline in the physical economy of the U.S.A., as a whole, since 1971-1972. Two aspects of this total picture bear directly on the implications of the application of Vernadsky's categories to the decadence, and net economic decline of U.S. domestic economic practice, as measured per capita and per square kilometer over the interval inclusive of the period from 1971-1972 to the present. (See **Figures 1-6**)

The decline of the area of Louisiana around New Orleans hit recently by hurricane "Katrina," is one noteworthy example of the recent forty years of destruction which, despite the wonderfully successful impetus of the Kennedy Moon-Landing program in its own right, the other economic policies of the U.S. government have imposed, during the recent four decades, upon the United States as a whole.

Look at the history of this region since the New Orleans area was struck by "Betsy," for example. What was specified for repairs and improvement there, ordered by President Lyndon Johnson at that time, was never done to the present day! However, the worst effects on that area came as a result of continuing trends in U.S. policy of practice over the period since 1971-1972, and under, for example, National Security Advisors Henry A. Kissinger and Zbigniew Brzezinski. Kissinger's role in U.S. foreign policy did terri-

11. Op. cit.

ble damage to the U.S. economy, indirectly; but, the worst of the direct damage done directly to the interior of the U.S., was launched under the 1977-1981 direction of Brzezinski. It is those changes, under Brzezinski's direction, which must now be quickly reversed, if the national economy is to be saved.

However, as guilty as Brzezinski, in particular, is, there is a deeper issue of policy-outlook involved, the intention shared among certain wickedly utopian, private international financier circles which motivated that intentional wrecking of the economy under Brzezinski. It is that intention which must be removed, if the practical measures of reversing those 1977-1981 policy-changes are to succeed.

In fact, this terrible record of U.S. and other decline in economy since 1972, is not a reflection of some natural tendency; but, is the product of the intention of the powerful utopian financier circles, the intention to transform the planet from a system of increasingly prosperous nation-states, into a greatly depleted kind of empire, now called "globalization." It is their expressed intention, that in that arrangement, in which the nation-state, where it were allowed, by exception, to exist, such governments would be mere lackeys of a Venetian-style, *ultramontane* world-wide imperial system, a system sometimes called "universal fascism" by ideologue and Henry A. Kissinger-linked Michael Ledeen and his fascist cronies.

This current goal of that neo-Venetian financier interest, is to be recognized, and understood, as a modern outgrowth of the same intention expressed as the concluding proposal of Lord Shelburne's lackey Gibbon, a new, Anglo-Dutch Liberal version of the *ultramontane* imperialism of that Venetian-style financier oligarchy which had dominated medieval Europe under the alliance between Venice and the brutish Norman chivalry.

Unfortunately, there are still many who commit the same blunder as V.I. Lenin and most of the social-democratic intelligentsia of the early Twentieth Century, who understood imperialism as a product of modern industrial society's colonialism, rather than, as Rosa Luxemburg insisted correctly, and the U.S.'s Herbert Feis later outlined that part of modern history, a resurrection of a pre-capitalist, Venetian-like mode of international financier-oligarchical rule, as illustrated by the anti-industrial rampage of the purely parasitical financier slime-mold, called the global cancer of "hedge funds," today.

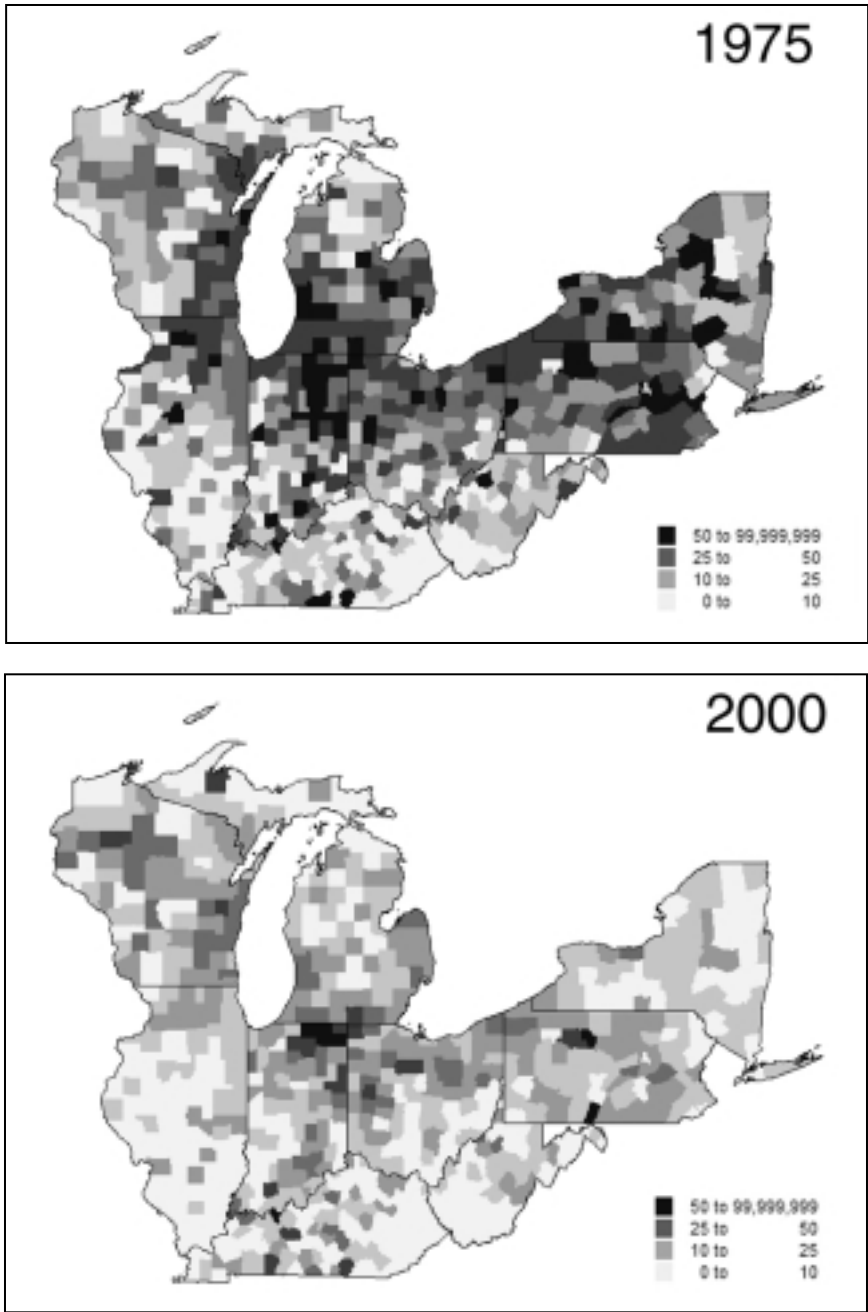
Such was the intention, the impetus behind the ruinous reforms made under the leadership of high-ranking modern *Leporellos* such as George Shultz, Henry Kissinger, and Brzezinski during the 1971-1981 interval.

The immediate impulse for Brzezinski's traumatic wrecking of the U.S. economy, was the outgrowth of his role in the design and leadership of the Trilateral Commission and its "Project 1980s" policy of "controlled disintegration of the

THE ANIMATIONS in this
section can be viewed at
www.larouchepac.com

FIGURE 1

Upper Midwest—Decline in Manufacturing Workers as Percent of Workforce, by County, 1975-2000



Source: Bureau of Labor Statistics. Map produced by Mapinfo.

This nine-state region from New York through Wisconsin and Illinois, has undergone a severe deindustrialization process over the 1975-2000 period. This decline accelerated during the 2001-05 George W. Bush years, and now faces overnight shutdown by the auto-sector crisis. Former leading industrial centers throughout this region—Buffalo, Cleveland, Detroit, etc.—have lost nearly half of their population along with their economic base, and are in acute financial crisis to maintain even bare-minimum urban government functions of police, fire, water, and sanitation.

U.S. economy.” A careening abandonment of maintenance of U.S. national and regional basic economic infrastructure, combined with the deliberate wrecking of agriculture, transportation, and power supplies, combined with the effects of Federal Reserve Chairman Paul A. Volcker’s 1979 launching of the Trilateral program of “controlled disintegration” through the financial measures of super-usurious interest-rates, typifies the relevant and ruinous developments of that time.

Look at these ruinous U.S. policy-changes of the 1970s in terms of their effects on the selected sample area including western Pennsylvania, western New York state, Michigan, Ohio, and Indiana. Look at the loss of basic economic infrastructure and shrinkage of population in formerly industrialized areas. See the willful destruction of mass transportation, other than highway transport; the collapse of the economic viability of the airline system and rails; power generation; catastrophic effects of downshifts in incomes by substituting marginal wage-levels of make-work or quasi-make-work “services employment” for skilled industrial and related employment. The vanishing of health-care facilities and availability, together with a general deterioration in sanitation. Accelerated lowering of the standard of public education, such that no one is “left behind” in their participation in a plummeting quality of public and private education generally. Loss of revenues to contraction and outright loss of high-gain industries. General reduction in viability and relevant quantities in basic economic infrastructure, including the now critical degeneration of the quality of water supplies and river and canal transport.

Look at the net catastrophic decline, over the recent three decades, in physical standard of living, in terms of both private income and public services, per capita and per square kilometer of territory. Meanwhile, the collapse of mass transport has nearly destroyed our functional territorial integrity as a sovereign nation!

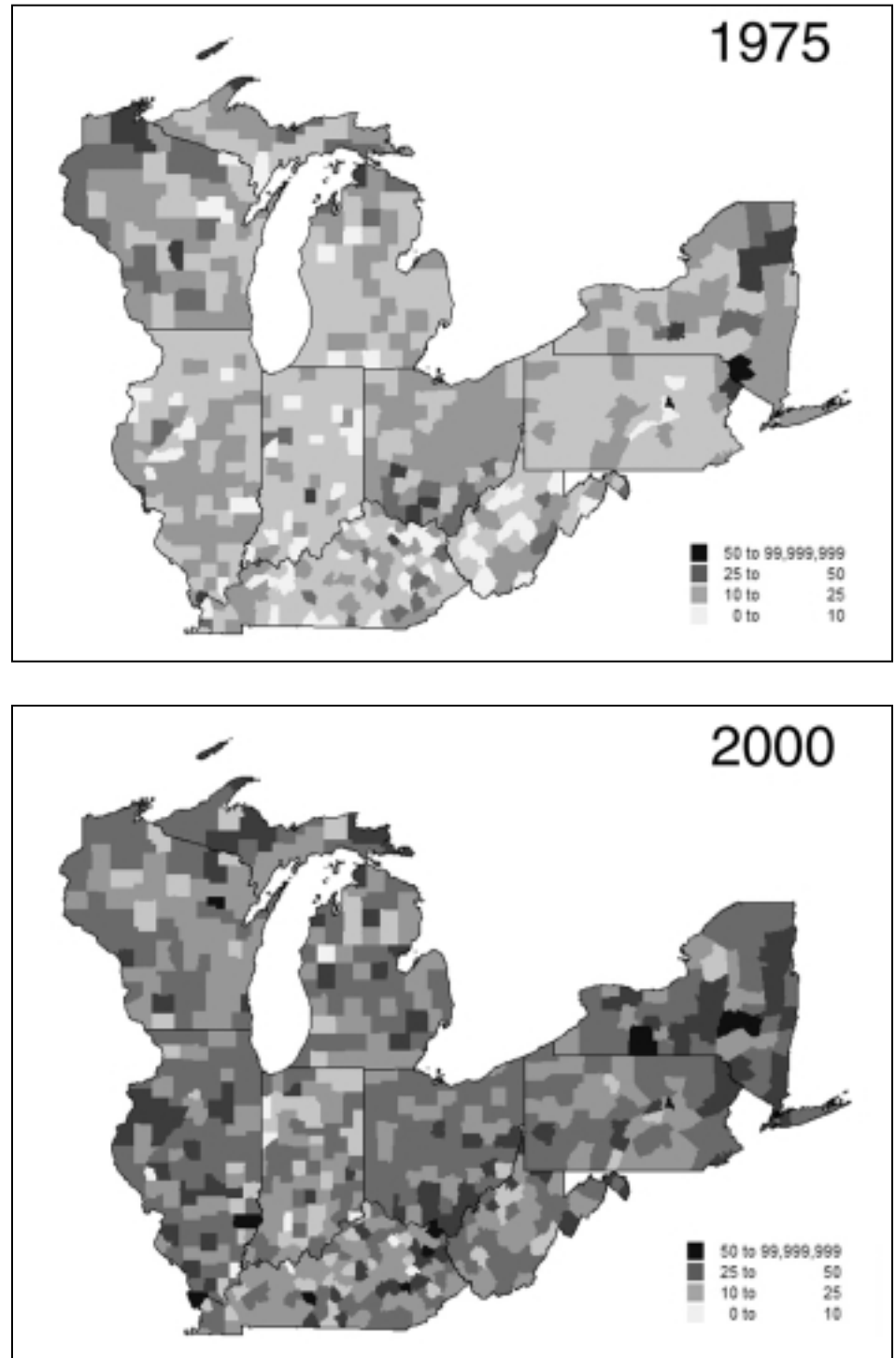
Michigan, for example, is now threat-

ened with being plummeted, like the state of post-Katrina Louisiana, into the category of not a “failed state,” but a “ghost state,” unless we take appropriate action, very soon, to prevent that outcome.

Yet, many Americans have protested my forecasts of a new downturn in the economy. Every one of those forecasts has occurred within approximately the time-frame I had indicated. Yet, protests, “Where was the crash you talked about?” poured in repeatedly after the particular phase of collapse I had forecast had already happened. The reason those self-styled critics of mine could have blundered repeatedly in that way, is that they were simply refusing to see the clear evidence of physical collapse of the economy spreading so flagrantly under their noses.

One among the important reasons for those kinds of foolish protests against my forecasting, was the popularity of the idea of a “services economy” among the 68er generation. Since they, or some people with whom they wished to remain on friendly terms, were pleased by the replacement of an agro-industrial economy by a “services economy” (where people earn their shrinking net incomes by taking in one another’s laundry), they refuse to see the loss of the factories, farms, and kindred places of employment as an economic downturn, even if the level of income of the employed members of the community has collapsed with the shift in employment from a producer, to a services economy. They refuse to see that the real inflation in the economy is also expressed by the deep deflation of the purchasing power and standard of living represented by use of public facilities, or the fact that

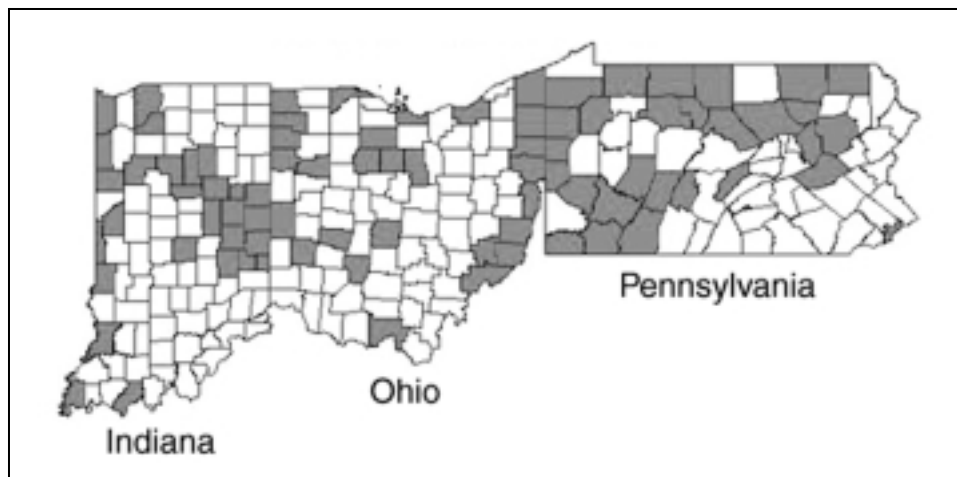
FIGURE 2
Upper Midwest—Rise in Services Workers as Percent of Workforce, 1975-2000



Source: Bureau of Labor Statistics. Map produced by Mapinfo.

FIGURE 3

Pennsylvania, Ohio, Indiana: Counties (Dark Tone) Which Have Lost Population, 2000-04



Source: U.S. Bureau of the Census; EIR.

The state of Ohio saw a 2.8% loss of population between 2000 and 2004, going from 11,353,140 residents down to 11,050,605. Under globalization, this tri-state region's population dropped from 29.715 million in 2000, down to 29.692 million in 2004, with population loss in 84 counties, out of a total of 246. The whole rural northern tier of Pennsylvania is being depopulated, as well as the western industrial concentrations.

the local water system, the power, the medical-care facilities, and other such systems are approaching collapse, if they have not already collapsed.

Since the rampages of George Shultz, Kissinger, and Brzezinski of 1969-1981, the economies of the Americas and Europe have been gripped by a long wave of physical decline. This decline has come in phases, one after the other, always primarily a physical collapse, but also expressed from time to time as a rude jolt to life inside or outside the U.S.A. expressed in the financial-monetary system, such as that next such about to strike soon.

Anyone who has lived as an adult during the recent years, who says that “the economy is looking good,” is in a state of denial tantamount to clinical insanity. They could not actually believe that the economy is not very sick; but, what they wish to believe is that the way of life they are hoping to get, or even to keep, will not be denied to them. When they can no longer believe the reality they are experiencing, they flee into sheer fantasy, so that they might cling more fervently to what they desire might be so. Denial is about as thick on the ground of the U.S.A. today, as lava sat so long upon doomed Pompeii.

How Those Popular Delusions Work

Let us now, for just a moment, step aside from the objective side of the science of the Noösphere, to examine the subjective side, to say something which needs to be said. I am pointing

out to you the importance of choosing a new pathway of policies, policies which you must adopt if we are to make our way successfully out of the immediately looming threat of what could become the worst global crisis in modern experience: unless we suddenly change our ways.

Consider so, now, and for later additional reference in this chapter, both the official and the popular ideology which refuses to face the implications of what I have pointed toward as these and related indisputable physical facts about the recent decades changes in the economy. Focus special attention on the perverse ideology which argues that the shift to a “post-industrial services economy” is a beneficial change!

Do you remember, that it used to be said, that “an Englishman’s home is his castle”? Be it a hovel or palace, it was his. It was something which he accepted as something which he was able to persuade himself to believe was “his own.” Consoling oneself to one’s apparent lot in life, is a delusion to which many cling fiercely, and often foolishly, a delusion often expressed by the magically Romantic slogan, “the way things are.” If we are alert, observant, we often hear this, and see this expressed in various ways, but always with the same underlying meaning, every day, in almost every place.

Take, for example, the surge of the cult-like rage of dance-marathon competitions during the period of what has been called the 1930s Depression, or the surge of gambling manias over the course of the recent quarter-century. Essentially, gambling is a form of insanity.

Once upon a time, in Boston, Massachusetts, there was a National Baseball League team called The Boston Braves, which, at that time, was considered among the habituated underdogs of the League. During a period of time, this team had two first-rate pitchers, Spahn and Sain, of whom it was said by the would-be poets of the local sports pages, “Spahn and Sain, and pray for rain.” The relevant fans took fierce pride in “Spahn and Sain.” Fans, and other people, when caught in what are for them hard, or simply fearful times, tend to think like those fans.

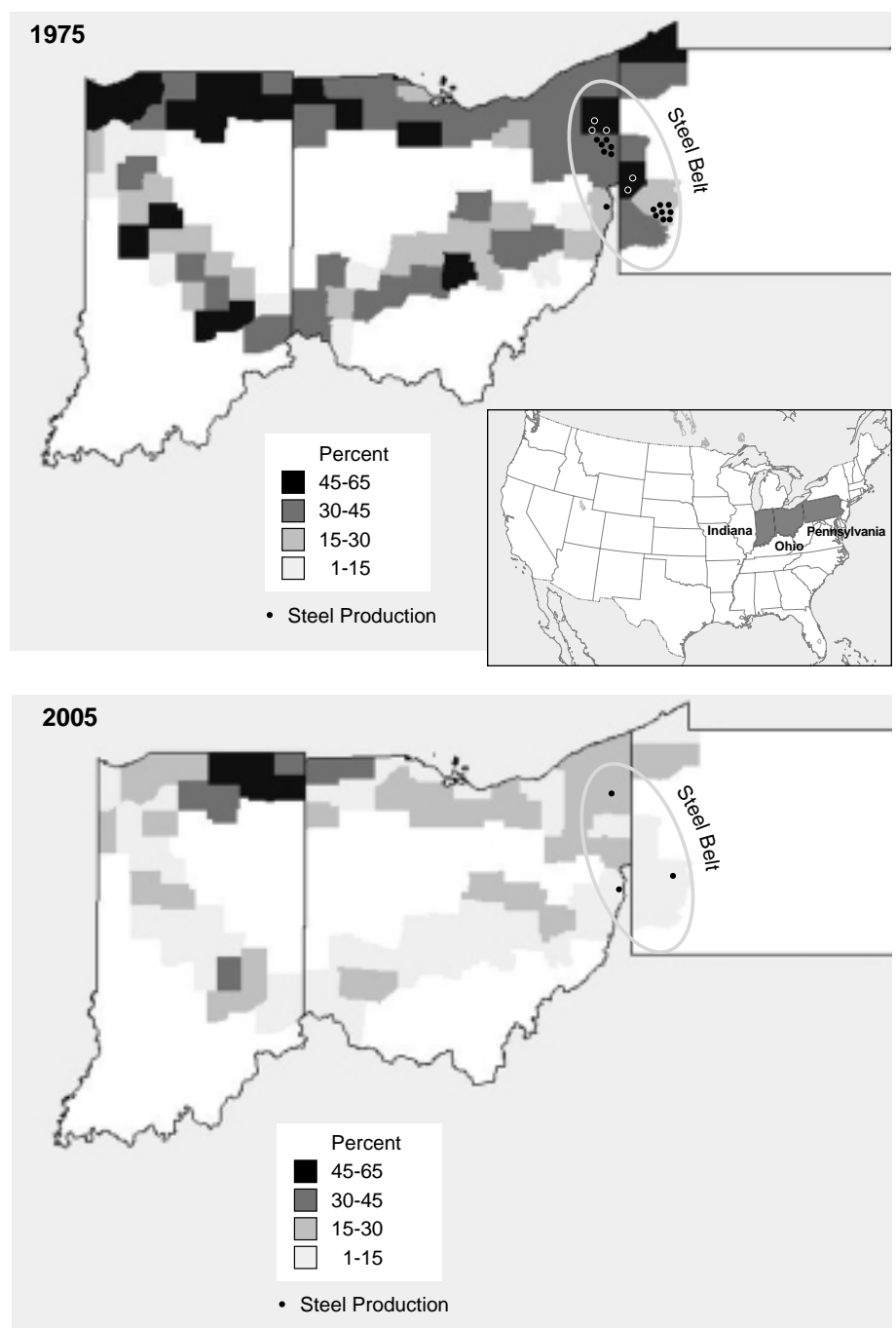
The worse things get, it is said by some, the harder you must try to believe that they are becoming better. Mass manias, including the gambling mania which grips the U.S. population

today, have their ebbs and flows, with the change of seasons. Today's financial market is almost purely a gambling mania, which, naturally, tends, in time, like Enron, to attract the impulses and trappings of a criminal class.

The time comes when one man says, "You can't beat City Hall," but the other man—I will not say I am quoting "Governor Jeb Bush"—replies, "Perhaps not; but you can sell it." Such are the mythologies regarded as common wisdom about human nature. After all, if you can not afford sanity, there is the option of living up to your lunacies, such as self-doomed political regimes of people who are willing to be paid to tolerate "hedge funds" today. "The last thing I remember him saying, was, "There is no quicksand here!" " These varieties of morbid sentimentalities often seize the imaginations of frightened people today: "What economic crisis? I don't see one!" Alfred E. Neuman breaks out in one of his perpetual smiles.

The underlying fact expressed by most of the popular delusions about today's economy, is the desire to deny the fact, that the present world monetary-financial system is ruled, not by governments, but by the concerts of private financiers, who control what are called central banks of nations, central banks which, in turn, exert a virtually imperial kind of dictatorial reign over the governments of the world today. "Hovel or palace, I believe in the system which I hope would shelter me." I have never heard any actually rational defense of the present, "floating-exchange-rate" form of the international monetary system from anyone, even at the highest rank in power. Yet, the defense, or, the apologies for that system is rampant belief at virtually all levels in society. Nearly everyone worships the system, either by pretending to love, or hating it, as the slave hates the master to whose whip he dutifully submits. I am one who does not share that

FIGURE 4
Pennsylvania, Ohio, Indiana: Decline in Manufacturing Share of Total Workforce (by County) Along Two Traditional Rail Routes; Collapse of Pittsburgh-to-Warren Steel Belt, 1975-2005

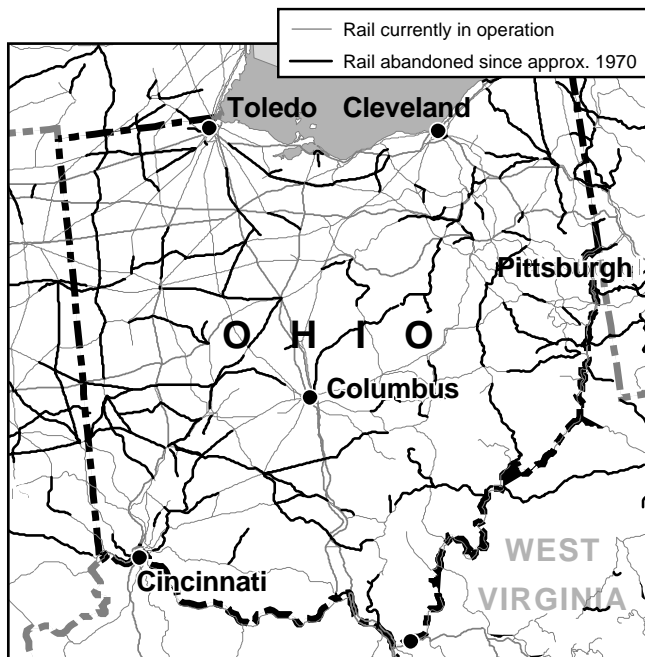


Source: *EIR* 2005, base map by Mapinfo.

This illustration shows the severe loss of manufacturing workers in this former heavy-industry region, mapped along two major east-west rail corridors, which have decayed drastically under the past 30 years of infrastructure neglect. The once world-class Pittsburgh-to-Cleveland steel corridor, is now shrunk to nearly nothing.

FIGURE 5

Rail Routes in Ohio—Existing, and Abandoned Since 1970 (Dark Lines)



John Sigerson / EIRNS 2002

delusion, for which it is sometime said of me, “I bet you hate motherhood and Christmas, too!” Some people think nothing is more cruel than to take away their foolish, consoling delusions.

There was never anything “natural” about this decline in the economies of the Americas and Europe. The fact that despite the later abortion, under President Harry Truman, of crucial elements of President Franklin Roosevelt’s intentions for the post-war world, the leading economies of North America and western Europe progressed, sometimes spectacularly, during the first two decades of the post-war period, and then began to collapse precisely during the late 1960s interval when those born during 1945-1950 came into young adulthood, is not a mere coincidence. The immediate post-war period was dominated, despite Truman’s and other actions, by the fact that Roosevelt’s reforms were the only available option for avoiding an economic disaster.

The possibility of destroying the U.S. economy required the emergence of a largely “brainwashed” new post-war adult generation, one systematically conditioned to the desire for a utopian “post-industrial” world. It was the rise of the so-called “68ers,” especially the most rambunctious varieties of devotees of a “white collar” system, which made possible the way in which the U.S. and European economies began to be wrecked and ruined over the course of the 1970s and beyond. There is no mystery in this if you study the propaganda output

of the Congress for Cultural Freedom and the union of efforts of the Fabian networks of Bertrand Russell with the fascist imperial ideology expressed by H.G. Wells’ *The Open Conspiracy*. We have been largely destroyed during the course of the recent forty years. As the corrosive spread of sophistry had brought about the self-destruction of Athens in the Peloponnesian War, we have been ruined by new sophists leading us into wars such as that in Indo-China and now Iraq.

The essence of competent economic thinking in the world today, is to begin to see things as they actually are, free of such popularized delusions as regarding the present Anglo-Dutch Liberal international monetary system as “inevitable,” as the Roman Empire was seen to be in its time, and as Lord Shelburne’s lackey and his soothsayer, Gibbon, promised the eternal victory of the attempted British world empire being launched at that time. Today’s ruinous trends are not the expression of the wisdom of inevitable developments, but the consequence of the reign of the kind of fools who, today, welcome “globalization” as invincible trends to which we ought, therefore, to adapt.

See the real world in which we live, as it is outside the fish-bowl of your popular delusion. For me, therefore, forecasting is not saying, “You are going to die tomorrow. Ha. Ha. Ha,” but the more timely, friendlier suggestion, “Step back from the quicksand into which your feet are already sinking, while you still can,” as I forecast for your benefit, once again, today, while you are already suffering the ills and torments against which I had forewarned you before. If you had wished to have someone read tea leaves to you, you should have found a gypsy: I do not make Delphic predictions.

See the Economy As Part of a Noösphere

The foolish fellows who believe that exporting production to cheap labor markets is either good, or merely the unavoidable consequence of an inevitable pursuit of a utopian world of free trade, assume that what the financial accountants tell us is the cost-advantage of the cheap labor found in nations which leave about seventy percent of their population, and the corresponding portions of territory, in a miserable state of ruin, are the wave of the future. Accountants and the like who would compose, or sign such reports, are either fakers or simply fools.

The most important factor in national physical productivity, and a nation’s prospects for long-term survival, depends chiefly on development of its total area’s infrastructure, and population. Simply add what should have been the paid costs of bringing the entire population of an outsource-nation and its territory up to a decent level of existence, to the price of the exports from that nation, and the cost of production in the U.S.A. and Europe suddenly becomes far cheaper than in the typical outsource-nation of today. The so-called evidence in support of “globalization” is nothing better than a fraud imposed upon the credulities of our fools.

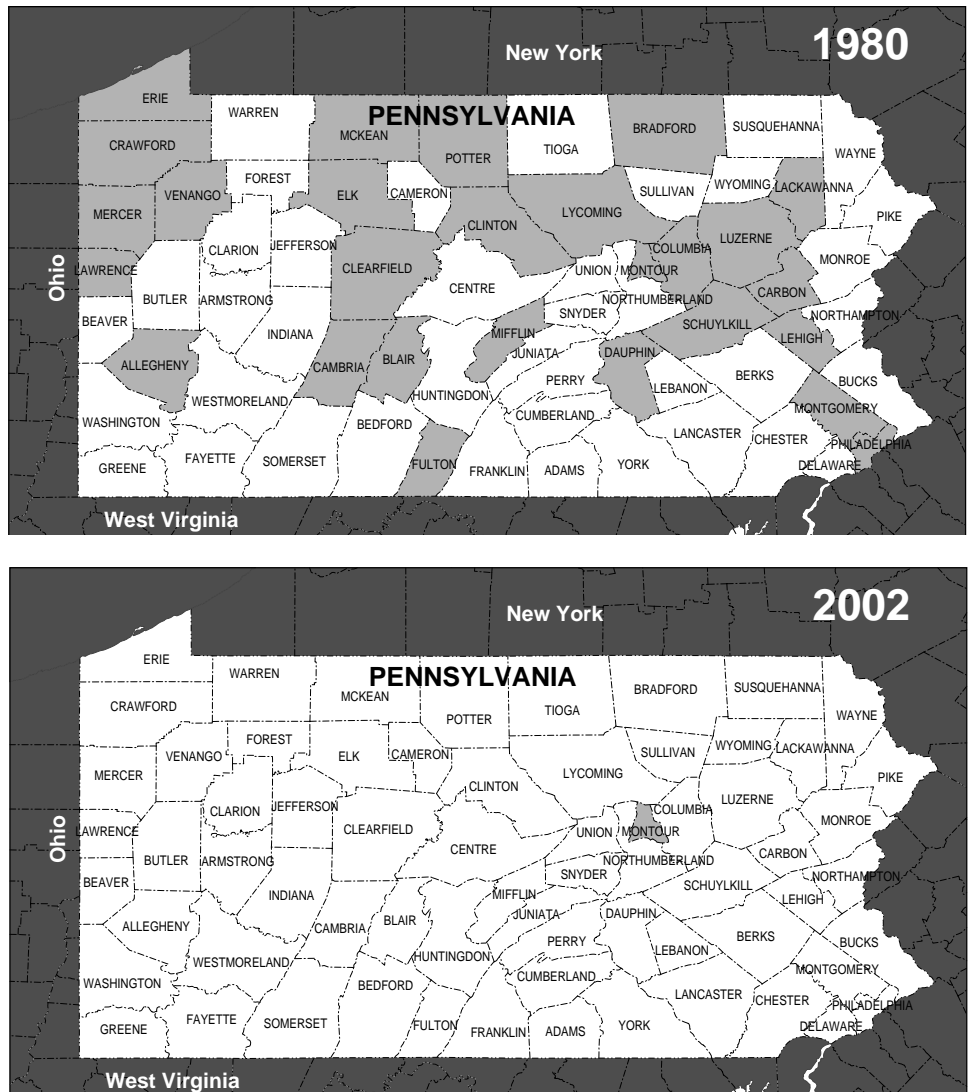
Similarly, there are people, still today, who actually believe the fairy-tale which says the wealth of the United States as a nation as a whole was built, in significant part, on slave labor. Some people profited from slavery, but certainly not the “poor whites” of the slave states, and not the nation as a whole. We were looted by European powers who looted us in the same way we loot so-called outsourcing economies, such as our neighbors Mexico and Central America. We loot them by buying their products at prices far below the actually incurred cost to that exporting nation and its people considered as a whole. We were looted, through the toleration of slavery, to the profit of, chiefly, the British Empire, as the financier interest backing the form of imperialism called “globalization” today, would degrade the citizenry of the U.S. chiefly to the levels of the vast sea of Third World poor. The world’s leading economist of the middle of the Nineteenth Century, Henry C. Carey, exposed the truth about the effects of slavery on the economy. Indeed, it was the elimination of slavery, combined with a return to the protectionist policies of the original American System of political-economy, which made us the envy of the world over the course of the 1863-1876 interval.

Instead of following the empiricist method of tracking events as such, limit your concentrated attention to principled changes in state of a system considered as a whole. That said, then examine the principled character of the functional, physical-economic relationships among the three lower of the four domains I have referenced, in terms of functions which correspond to such changes in states.

In other words, mankind acts, at his best, on the initiatives

FIGURE 6

Pennsylvania: Decline in Counties Meeting Hill-Burton Standard of Hospital Beds per 1,000 Persons



Source: Pennsylvania Department of Health

In 1980, twenty-seven out of Pennsylvania’s 67 counties met or exceeded the number of community hospital beds per 1,000 residents, under the Federal standard set under the 1946 “Hill Burton” principle, of providing medical infrastructure based on density of population. But by 2002, none of its counties, except for Montour, home to the endowed Geisinger Hospital system, met the standard. The Pennsylvania pattern characterizes the takedown of health-care infrastructure of the nation. In Ohio, for example, there were 3.4 public hospital beds per 1,000 residents in 1958, which ratio fell to 2.9 per 1,000 in 2001.

of sovereign individuals, to practice a discovery of principle upon the domain of the Noösphere. The action upon the Noösphere, in turn, generates an action on the Biosphere, whose effect, in turn, acts to produce a change within the abiotic domain. Now, that said, tile the surface of the continental United States and also its coastal waters, as if county by coun-

ty. Measure all appropriately selected, qualitative changes in state, county by county, or similarly, per capita and per square kilometer. In this way, assemble statistics which accomplish the following result.

It might appear, therefore, in taking the configuration I described as defining the top of the system whose changes in state are being measured, that it is the individual's action which is the apex of the pyramid, so to speak. Then, on reflection, we think, "But where does that acting adult individual come from? What produces him or her in the relevant state of capability?" Let us call that "standard of living in family and community life." It is the cultural, as much as simply physical standard of development of the member of society which generates the variable level of potential, economically significant physical action which is the productive individual's action within and upon the pyramid as a whole.

But, hold that for a moment! The significant action of the economically productive individual of this pyramid, is creative mental activity, mental activity of the type which generates an experimentally validatable discovery of a universal physical principle. This requires not only a relevant standard of life within the community, but an integral orientation toward fostering what is equivalent to creative scientific discovery, or comparable Classical modes of artistic practice: preferably both.

However, this development of the social process on which the individual, so oriented, depends, demands also the orientation of social life in the community, and its productive practice, toward the effective equivalent of scientific and technological progress. This means not only the development, or replication of valid scientific and Classical artistic discoveries of principled action, but conditions associated with an effective orientation toward their principled application to improve the relative productive powers of the nation.

Throughout the mapping of the tiled surface of the nation, only changes of that quality are to be considered as primary determinants.

Recognize that the kinds of changes toward which we are pointing now, are of the quality we have identified as "powers," powers in the sense of the invisible, but real physical action accomplished in Archytas' doubling of the cube. Thus, we have the *powers* characteristic of the Noösphere acting on the *powers* within the Biosphere, which are acting, in turn, on the *powers* internal to the abiotic domain. The net result of the individual's creative action upon the Noösphere for the three-fold system as a whole, is expressed as the degree of amplification of human action within the Noösphere on the subordinate domains, the Biosphere and abiotic domains, respectively.

In practice, in today's modern economy, that means that about one half of the total output of society within the economic process must be devoted to creative work and maintaining basic economic infrastructure, largely infrastructure

of the public, not the private sector. It is therefore instructive to re-read Treasury Secretary Alexander Hamilton's report to the U.S. Congress *On the Subject of Manufactures*, to compare it with what I have just summarized, immediately above.

The American System of political-economy is not a "capitalist system," either in the sense that the British have taught, or the credulous socialist movements have believed. It is, above all, never a "free trade" system, except in times in which it has preferred to drive itself into bankruptcy. It is a "fair trade" system, based upon a partnership between the private sector and the role of government in a.) Exerting a monopoly in the creation and management of national credit, b.) of uttering a currency which is managed by the government to c.) ensure national goals for improvement of the standard of living and productivity of the population, and their general welfare as a whole, and to promote and to harness that true creativity in physical science and Classical art, which exists only as a sovereign capacity of the individual human mind.

Of late, the worst shortfalls in intellectual competence respecting our national economy have been in two general categories of failures. First, it is necessary to correct for the disastrous effects of the presently prevalent failure to understand the necessity of "fair trade," rather than "free trade" policies, and the importance of an aggressively capital-intensive mode of development of such basic economic infrastructure, as, most notably, sanitation and health-care, mass transportation, power generation and distribution, education, and developing and maintaining an integrated, public, water management system throughout the entirety of the national territory. Second, it is necessary to curb the spread of employment in unskilled, labor-intensive (and low-paid) modes of labor, and to concentrate employment more and more, away from unskilled or low-skilled services employment, into technologically high-gain physically productive output in infrastructure and private agriculture and industry.

On this account, look at such states as Ohio, Indiana, and so on, as cases in which we can see the effects of a shift from skilled agro-industrial productive employment, to low-skilled services employment, on the gross income and tax revenues of the state, and its counties and municipalities. The loss of tax revenues whose combined direct and indirect origins are technologically advanced, largely capital-intensive modes of output and employment, to services employment, has been a catastrophe for the state, and its population, at all levels. It is the level of useful physical output, per capita and per square kilometer of total and average territory, which determines the attainable possibilities for sovereignty and decent social life for the territory and its population. The shift to a "services economy" has been a mass-murderous act of rape of the nation and its population, a bestiality which must be ended and its effects reversed, if society is to survive now.

This needed emphasis on capital-intensive, science-driven productive development, should be seen as I have described the implications of the Noösphere above. Measure performance not simply in physical acts of production, but in the gains in quality and quantity of productivity through a constant emphasis on a rapid pace in development and application of fundamental science-driven progress, at all levels of the Noösphere, Biosphere, and abiotic domain. It is the improvements in net physical productivity contributed by application of science-driven discovery at all levels, which provide the impetus of *powers* in the Pythagoreans' sense, on which the multiplication of the average productive powers of labor and general improvement of the quality of human living are maintained.

To meet that requirement, we must not treat the presently accessible fossil deposit of so-called raw materials within the Biosphere as implicitly finite. We must reach beyond reliance upon fossils for either regeneration of the materials a growing and developing world population requires, or for the substitution of synthesizing vast quantities of alternatives. For the moment, the supply is still vast, provided we take the oceans into account. However, the rate of consumption of such requirements will rise; instead of robbing what some think of as "nature's bank," we must replenish the supply of deposits in that bank, either of types presently used, or excellent alternatives which we, through science, must create.

All of these requirements for reviving and improving the world's economies, demand a high and accelerating emphasis on fundamental scientific progress and its applications. This demands a shift from reliance on habits, to dependency upon powers as the Pythagoreans defined powers.

In short, it is urgent to emphasize the role of the principle of power, as I have emphasized the correct scientific significance of the term power here. The national and world economies must be managed by the respective, cooperating, sovereign authorities of what is consciously understood to be a Noösphere, as I have broadly outlined that definition's application here.

4. The Concept of Leadership

Economy is not something which happens to mankind. It is what mankind does to create economy. An ecology, as ecology was usefully defined as a term, is not an economy. Only the human species creates and develops an economy. Only pitifully superstitious folk, believe the contrary still today.

This action by mankind is brought into being as a product of the perfectly sovereign cognitive powers of the individual mind, which shares its knowledge of discoveries of principle and their appropriate use with the cognitive powers of other

persons. This form of generating and sharing relevant cognitive experiences is the true leadership on which the continued existence of a healthy economy depends absolutely.

Science and the practice of Classical artistic composition, are, or should be, the prototypes of the quality of leadership. Thus, societies which tend toward the ugly persuasions of the evil Olympian Zeus, will tolerate scientists and Classical artists, only to the degree they make them silly, as the case of the malevolent Bertolt Brecht illustrates this fanatical devotion to satanic-like qualities of silliness, or herd them into compartmental refuges, such as academic ivory towers, outside what is considered the mainstream of efficient political life.

The question thus posed by the comparison of the relative success under Franklin Roosevelt's leadership, and the disastrous trend in U.S. and world economic affairs since about 1964-1968, is, what is the nature and role of leadership in determining the fate of nations' economies? How was U.S. leadership lacking over the recent four decades, and what should be done about that? In part, we must blame the brainwashing of the relevant echelons of the "Baby Boomer" generation, who were indoctrinated, massively, by the influence of predatory institutions such as the Congress for Cultural Freedom which taught the Adorno-Arendt dogma of "the authoritarian personality."

The vitality of any nation, and of its physical economy in particular, depends largely upon the role of a certain quality of leadership, a leadership expressed in an indispensable manner and degree by the outstanding role of individual leaders, who are leaders in many aspects of national cultural and economic life. This quality of leadership, in whatever costume it is guised, is defined by the same principle of creativity which is expressed by the example of Archytas' solution for the Delian paradox. This is the essence of leadership in Classical artistic performance, in all facets of the practice of successful progress in physical science, and in the creative innovations such as those in the machine-tool sector of production, in creative management of enterprises' dedication to the products of scientific creativity, by the modern progressive farmer we have done so much to eliminate since the late 1970s, and often simply in the contents of the industrial factory suggestion-box.

Leadership is leading others to achievement through ideas which have the distinctly human quality of creativity which I have addressed in the two opening chapters of this report.

It is that element of creativity which has been eliminated to a very large degree by the social trends in behavior, and in education, and in novel parodies of ancient Greek sophism, called today "democracy," from its first set of victims, the so-called "Baby Boomers," on.

For example.

Back during the early 1960s, during one of my assignments

as a consultant to a public corporation, an energetic sales manager gave way to an outburst in the course of sharing confidences personally with me, “Where are the tycoons?” That choice of term was inappropriate, because the U.S.A. had not yet run out of competent leaders in corporate and other business management, but, his feeling about the matter which prompted his outburst was fully justified, and the type of problem to which he was reacting, in what I knew was his immediate situation, was already widespread and increasingly so at that time.

The bane of my experience, and of the existence of otherwise healthy enterprises I met, during those days of consulting, was the accountants and finance departments, especially those who saw themselves in the role of Wall Street’s assigned supercargo. The function which they should have been assigned to perform was necessary; but, they went much too far when their cultivated, often disgustingly pompous arrogance, went so far as to make the totally unjustified assumption, that submission to accounting and related financial functions were the only way to generate, or ensure, economic progress. The needed competence, which tended to be focussed in the production management and related executive functions, was expressed in the efforts of such leaders to prevent the Wall Street representatives in the board room from ruining everything. What Mrs. Joan Robinson once denounced as the silliness of that refugee from accounting school, Milton Friedman’s, *post hoc ergo propter hoc* alleged view of the future, typifies my encounters with the Wall Street types and their would-be lackeys. The opposition from the Wall Street-influenced accounting and financial management gang, was the biggest single cause of frustration, and the ever-looming threat of impending financial corporate disaster.

The lack of competence these trends express, is dominated by a loss of the capacity for truly human thinking—creative thinking of the type which the Archytas case illustrates, in more and more of those positions which function as institutional leadership. The substitution of trick accounting methods for actually thinking, is typical of the devastating loss of creativity in our business enterprises today. After that, for some people, “stealing,” or other forms of cheating are considered



EIRNS/Neil Martin



EIRNS/Philip Ulanowsky

“Education in science and Classical art, for fostering creativity more than mere learning, in that generation, is the hope of the world for the future.” Left: Lyndon LaRouche talks with LaRouche Youth Movement members at Washington, D.C. conference. Above: A LYM cadre school explores the Platonic solids in Toledo, Ohio.

popular styles in substituting for a lack of actually human qualities of personal creativity. Enron, for example.

The present rampage of hedge funds is essentially a mere amplification of the tendency which was already in gestation during the 1950s and early 1960s. Hedge funds, disguised as the knight errants of “shareholder’s values,” move in on a more or less viable corporation, slash programs for the purpose of accumulating cash in the short term, then dump that cash from asset-stripping of the firm down the memory hole of enhanced distributions to officers and stockholders, and then abandon the looted firm to ruin, while the Jolly Rogers of those hedge funds scamper away, looted cash in pocket, to practice the same act of sheer piracy on a next choice of victim of the day. In some circles, this sheer piracy is considered legal! It is considered the merry practice of “shareholder value”!

Currently, the challenge of saving the U.S. economy from a virtual breakdown caused by looting and closing down of key elements of the automotive industry, compels us to look back to certain “crash programs” of the past, such as the mobi-

lization leading from the outbreak of the Civil War through the 1876 Centennial celebration, the mobilization for oncoming World War I, the mobilizations headed by Harry Hopkins and Harold Ickes back during the 1930s, and the economically brilliantly successful Kennedy manned Moon-landing project. To understand how those mobilizations succeeded in accomplishing seeming miracles, as they did, we have to look back to the roots of our national economic character in the pre-1688 Massachusetts Bay Colony, the role of Benjamin Franklin as an economics leader in the industrial development of England and in the U.S.A., and the Reports to the U.S. Congress by Treasury Secretary Alexander Hamilton.

Generally, although the Wall Street-controlled public stock company turned out to be an absolute, or relative disaster for our nation, sooner or later, some public corporations did succeed in performance for the national interest for a time, but, usually, these were enterprises which had begun their existence as relatively closely held entrepreneurs, or were compelled to act to that effect under law by governments which tended to tolerate no nonsense of the sort for which the Bush-Cheney Administration has been so monstrously notorious of late. "Entrepreneur" in that sense of the term was that toward which my interlocutor's intention was pointing in his use of "tycoon."

The use of the term "leadership" ought to be limited to one of several varieties of a certain common type of personality, the type of personality which the Frankfurt School's and Congress for Cultural Freedom's Theodor Adorno and Hannah Arendt hated and denounced as the type of the "authoritarian personality."

That was that pair's own leading contribution to the destruction of our United States, and also that of civilization for as far as their influence might possibly reach. What that pair was denouncing in that way, was the principle of leadership on which the success of any society and its economy depends absolutely. That perverse notion, as echoed in the perverted Samuel P. Huntington's notion of "democracy," is the essence of the influence which has led the United States virtually to destroy itself, economically and otherwise, over the course of approximately four recent decades. That goes to the justified outburst of my acquaintance the sales manager on the subject of "tycoons."

Apart from her relationship to her Nazi intimate Martin Heidegger, Arendt's leading contribution to the generality of intellectual depravity emitted by the "Frankfurt School" as a whole, was her association with fellow-existentialist Karl Jaspers in a convoluted argument against the existence of truth, which she premised on the *Critiques* of Immanuel Kant. Essentially, what Arendt and Adorno denounced as "the authoritarian personality," is simply a person who is both knowledgeable in relevant ways, and also truthful, as Arendt and Adorno were, most sincerely, not.

The opposite of such truthfulness, is called sophistry, an

emulation of the same quality of sophistry by which ancient Athens was led to destroy itself in the Peloponnesian War. It has been that quality of sophistry inherent in the "authoritarian personality" dogma of the wretches Arendt, Adorno, Bertolt Brecht, et al., which has been the induced leading characteristic of the upper twenty percentile of the income brackets of our so-called "Baby Boomer" generation, and has become the general characteristic of our leading "yellow" and other press, and also the entertainment media.

How To Build Leaders

There are three things which need to be done, to mobilize the present population of the U.S.A., and also Europe, for example, up and out of the prevalent morbid state of passion and intellect into which most have been dumped.

First, mobilize society, especially its economy, around the kind of mission-orientations in every useful field of activity which compel people to define achievement as improvements realized through cooperation in achieving goals which are clearly fruits of creativity as I have defined creativity here. Structure the institutions of which society is composed to prefer activities which are explicitly demands for creativity, as opposed to other goals-orientations.

Second, focus on needed reforms in the education of the young, with great emphasis on the critical segment of the population in the 18-25 young-adult age-interval which is associated with the idea of a professional trained in a university, as I have prescribed for the pioneering LaRouche Youth Movement, in the Americas, and within Europe. Education in science and Classical art, for fostering creativity more than mere learning, in that generation, is the hope of the world for the future.

Organize the economy as a whole around a great project-orientation, such as the integration of global scientific programs around the idea of space-exploration. Every branch of economy, and of learning, is brought together by thinking of mankind as creative beings presently dwelling on one planet of a Solar System over which our species must achieve, phase by phase, management-control for survival and progress over the generations to come.

We must change the image of man from the relatively poor conception prevalent today, to a notion of man in the image of the Creator, mankind with a mission in the universe, a mission in which persons should enjoy the right of a sense of participation in this great, universal mission. We require sovereign states, because that is the only way in which the effective cultural development of the new individual can occur; but we are otherwise one species with one unifying mission for all time to come. We must reflect that imparted sense of personal identity in each sovereign individual person. We must look upward to space, so that we are impelled, even within our daily missions, to see ourselves and one another in a better way than mankind generally has seen mankind in the past.

Cheney Is the Albatross Around George Bush's Neck

by Jeffrey Steinberg

Vice President Dick Cheney lost a decisive White House policy battle on Dec. 15, when President George W. Bush staged a photo opportunity with Republican Senators John McCain (Ariz.) and John Warner (Va.)—two of Cheney's biggest Republican Party critics—to announce Administration capitulation to bipartisan, bicameral Congressional demands that the United States repudiate torture. The White House session, where it was announced that the President supported the McCain amendment banning any American violation of anti-torture conventions, came just hours after the U.S. House of Representatives, by a veto-proof 308-112 vote, passed a resolution, instructing House conferees, hammering out a final defense budget, to support the McCain language.

Cheney ally and House Armed Services Committee chair Rep. Duncan Hunter (R-Calif.) denounced the Bush-McCain deal and said he would seek to block it, but the message coming from the White House was clear.

Adding insult to Cheney's injury, the House resolution was sponsored by Rep. John Murtha (D-Pa.), whose Nov. 17 call for a U.S. military withdrawal from Iraq on a six-month timetable, triggered a national debate on a viable exit strategy. Murtha became the target of a Cheney-orchestrated smear campaign, which backfired against the Bush White House, and in effect, broke the Administration's nearly five-year vise-grip on the lower house. A core group of moderate Senate Republicans has already broken with the Cheney-led White House, after the failed "nuclear option" showdown in May.

The flight-forward against Representative Murtha also put Cheney in the unenviable position of being at war with the entire uniformed U.S. military command, which moved preemptively, through the Congressman-war hero, to force an end to the Iraq quagmire, while the U.S. Armed Forces are still barely intact.

According to well-placed Washington sources, the Bush decision to cave in to McCain, Warner, and other Congressional leaders aligned with the uniformed military, marked the fourth time in the last six months, that the President has broken with Cheney on a substantive policy issue, and sided with other Cabinet officials.

However, senior Washington policymakers cautioned that so long as Cheney is still in office, the United States is in serious trouble. The President and the Vice President still hold weekly private lunches, through which Cheney exerts extraordinary power over the malleable Mr. Bush.

It's Not Only Torture

Some leading Republicans, however, are trying to convince the President, and his closest confidants, that Cheney has finally become such a liability that he has to be dumped. Developments over the U.S.A. Patriot Act and the related issue of domestic spying by the National Security Agency, which broke dramatically immediately after the Administration agreement with McCain, drove that point home. Cheney was the individual who took the point, both on violating the Foreign Intelligence Surveillance Act (FISA), and on demanding the expanded police-state measures of the Patriot Act. On both issues, a bipartisan grouping in the Senate is refusing to kowtow, with the Patriot Act now put in limbo, and investigations into the President's violation of the FISA law being put on the table.

It's not hard to see that removing Cheney would remove a good number of the President's problems.

Adding to the complex White House picture, former President George H.W. Bush has let it be known to GOP intimates that he wishes to "contain" Cheney's influence over his son, rather than force the Vice President's ouster, and pave the

way for a new policy team to guide G.W. through the final three years of his Presidency. This is the same senior Bush whose own egotistical blunder led him to allow Cheney and George Shultz to mold the entire “Bush 43” Presidency, with disastrous consequences.

Cheney spent the better part of the last month twisting arms and pitching fits over the McCain amendment, which, he argued, would undermine U.S. efforts in the war on terrorism. Cheney argued for a loophole, exempting the CIA from the torture ban.

Cheney’s efforts only triggered a new revolt by a group of 33 leading intelligence community veterans, led by former CIA Director Adm. Stansfield Turner (ret.), who explicitly opposed the CIA exemption.

Firestorm Over ‘Rendition’

When Secretary of State Condoleezza Rice travelled to Europe for a series of meetings in early December, she was ambushed at every stop, over the issue of secret U.S. torture prisons in secret locations in Poland and other eastern European countries. The *Washington Post* had triggered a firestorm in the European Union by leaking details about the secret torture prisons last month, as well as several hundred unauthorized CIA and military flights, carrying suspected “terrorists” who had been captured through “extraordinary renditions”—Cheney-speak for kidnappings.

During her meeting with the new German Chancellor, Angela Merkel, Rice, in effect, changed Bush Administration policy, by vowing that there would be no more U.S. violations of international conventions and treaties banning torture. Merkel infuriated Bush Administration officials, particularly Cheney, when she publicly reported that Rice had “admitted” that the U.S. policy had been wrong. Rice reportedly had authorization from President Bush to alter the policy, in the event of a diplomatic fiasco, but her action caught Cheney and his top staffers by surprise.

Cheney’s new chief of staff and general counsel, David Addington, was the principal author of the White House memos arguing that the events of 9/11 justified violating the Geneva Conventions, other international agreements, and U.S. laws barring torture.

Even before Rice’s plane touched down on U.S. soil, following the disastrous European trip, the “Cheney-Rumsfeld Cabal” launched an information-warfare campaign against the European governments, leaking a story to London’s *Sunday Telegraph*, claiming that a January 2003 meeting of American and European Justice and Interior Ministry officials had agreed to cooperate on “extraordinary renditions.”

The real question, however, was what would happen back in Washington when Rice returned. Would Bush side with Cheney and buck Congressional Republicans and world opinion, or would he slap down the “Vice President for Torture”? The Dec. 15 White House Bush-McCain photo-op signalled that Bush was forced to break with Cheney’s tortured logic.

Further adding to the fiasco was a story, published in the British weekly *The Observer* on Dec. 11, detailing another case of “extraordinary rendition” and torture. Binyam Mohammed, a 27-year-old Ethiopian living in England, was kidnapped while visiting Pakistan in April 2002, and held in several U.S. and British secret prisons, including in Morocco. Under torture, he “confessed” to being part of the al-Qaeda cell that was plotting to smuggle a “dirty bomb” into the United States, in league with Jose Padilla, another alleged al-Qaeda terrorist arrested in the United States shortly after 9/11.

Mohammed later told his lawyer that he never heard of Padilla, had no al-Qaeda ties, and did not even speak Arabic, but had succumbed to the torture and signed the prefab “confession” provided by his interrogators. When the Mohammed case came to light, the Padilla case blew up. Nevertheless, Mohammed was “rendered” to Guantanamo Bay, where he is currently being held, and is scheduled to be tried by a military tribunal as a member of al-Qaeda.

The *Observer* story quoted senior CIA sources that the Agency is in “deep crisis” over the torture/kidnapping policy, and many senior case officers are quitting, rather than stand trial later for serious crimes.

Rumsfeld Out?

The Washington rumor mill has been buzzing with talk about the breakup of the “Cheney-Rumsfeld Cabal,” a term coined by Col. Lawrence Wilkerson (ret.), former chief of staff to former Secretary of State Powell. Several senior intelligence-community sources have stated that Defense Secretary Donald Rumsfeld will be leaving next year—by no later than the Summer.

One sure signal that the “vacancy” sign is being prepared at the Pentagon is the manic behavior of nominal Democrat, Sen. Joseph Lieberman (Conn.), who raced off to Iraq on a “fact-finding” mission. His findings: Bush’s policy is succeeding, and “mission accomplished.” All that was missing was the jump-suit and the *USS Lincoln*.

While Lieberman’s name has been floated as a replacement for Rumsfeld, more attention has been focussed on a replacement for Cheney himself.

Senior Republican Party sources have confirmed that a group of anti-Cheney GOP “bigwigs” are touting Senator McCain as the “clean-hands war hero” to replace Cheney as Vice President and reinvent the Bush Presidency. While the McCain fever has not yet hit the White House, the fight inside the Republican Party is intensifying by the hour, as GOP members of the House and Senate contemplate a midterm election earthquake if Cheney remains in office.

Meanwhile, Cheney’s impolitic decision to stage a high-visibility fundraiser in Houston on Dec. 5 for the embattled Rep. Tom DeLay (R-Texas), has suddenly put the spotlight on the Vice President himself, in the scandal surrounding Jack Abramoff, the indicted lobbyist-moneybags for the DeLay, Inc. political-thug machine.

Breaking Developments

LaRouche Blasts Rohatyn: 'A Tale of Two Bozos'

In a statement issued Dec. 13, Lyndon LaRouche exposed synarchist banker Felix Rohatyn's latest ploy, as a "silly swindle" intended to counter the positive motion of the Democratic Party Congressional leadership toward adopting a serious economic recovery program. LaRouche's statement, entitled "How Not to Build a Recovery: A Tale of Two Bozos," ripped the facade off the opinion column signed by Lazard Frères investment banker Rohatyn, and former Senator Warren Rudman, in the Dec. 13 *Washington Post*.

LaRouche identified the Rohatyn-Rudman piece as a "product of their delayed reaction to Nancy Pelosi's address" of Dec. 2, where the House Minority Leader enunciated the Democratic Party's intention to pursue a NASA-style recovery program, to save the U.S. economy.

"The Rohatyn-Rudman scheme is pure swindle," LaRouche wrote. "They have no intention that anything like their proposed NIC [National Investment Corporation—ed.] would work. They are hoping to dupe a sufficient number of suckers into believing that it might work, to prevent the U.S. Federal Government from doing the only thing, Franklin-Roosevelt style, which is, in fact, the only possible means for preventing the U.S. from collapsing soon into the worst and deepest depression ever, and that soon.

"The first line of defense of the U.S. economy against a deep and early depression is the willingness of the U.S. government, under the clear provisions of our Federal Constitution, to take the bankrupt Federal Reserve system into receivership by government, to keep the bank doors open and the banks functioning, and to reorganize a credit-system which will launch the large-scale investments in infrastructure and private industry sufficient to repeat the miracle which Franklin Roosevelt's Administration accomplished during the 1930s.

"Once the U.S. government begins to play that role, it will be sovereign governments which rule the world, not predatory loan-sharks like Rohatyn and his accomplices. . . ."

LaRouche's full statement, which was immediately circulated on Capitol Hill, can be found, along with relevant Rohatyn excerpts, at www.larouchepub.com.

Deutsche Bank Is Shaken By Real-Estate Crisis

For the first time ever in post-war Germany, a so-called "open-ended property fund" was closed on the night of Dec. 13 due to an imminent liquidity crisis, the financial daily *Handelsblatt* reported Dec. 15. The Grundbesitz Invest fund counts 300,000 investors and belongs to DB Real Estate, Deutsche Bank's real-estate subsidiary. Its total capital amounts to 6.7 billion euros, invested mostly in office buildings, of which two-thirds are located in Germany.

On Dec. 9, DB Real Estate announced that due to the need for an overall re-evaluation of the real estate owned by Grundbesitz Invest, the fund would no longer accept any new investors. By the end of the day Dec. 13, the fund was running out of cash.

The Deutsche Bank crisis reflects the situation of banks internationally, which have been propping up their books and the system with hyperinflated real-estate "investments."

Argentina Fights Against IMF Dictates

On Dec. 15, Argentine President Néstor Kirchner announced his decision to pay off the entirety of Argentina's debt to the International Monetary Fund. Kirchner brought together provincial governors, mayors, labor leaders, legislators, the heads of the Armed Forces, and business leaders at the Presidential palace, to be present for his announcement that Argentina would pay the \$9.8 billion owed to the Fund, using reserves, and explained his decision.

The debt to be paid to the Fund, Kirchner said, "has been a constant vehicle for interference, because it is subject to periodic review and is a source of demands and more demands. . . . The International Monetary Fund has acted toward our country as a pro-

motor of, and vehicle for, policies which caused poverty and pain among the Argentine people." The relationship with the IMF has led to a "real addiction to indebtedness, in which our creditors increasingly raised interest rates, toughened their auditing, control, and demands." With this \$9.8 billion payment, President Kirchner emphasized, "we are burying a good portion of the ominous past, that of infinite indebtedness and eternal adjustment."

Not surprisingly, Kirchner's decision has made the international bankers nervous, since they anticipate he will now feel even more emboldened to challenge the IMF's diktats.

Standard and Poor's Acting for Kerkorian?

The rating agency Standard and Poor's has been caught red-handed, playing the game of thieves—in this case, the thief being Kirk Kerkorian, the asset-stripper who has his sights set on the cadaver of General Motors. On Dec. 12, S&P downgraded GM bonds, once again, to far, far below junk grade. This came just days after the GM board, in the first sign of sanity in a long while, refused to allow a Kerkorian flunky to be placed on the GM board (Kerkorian has a 9.9% stake in GM), on the grounds that he would be privy to inside information that Kerkorian would be likely to use to profiteer from a GM collapse. Lyndon LaRouche asked the obvious question: Is "Standard & Whores" working on behalf of Kerkorian?

More of the behind-the-scenes manipulation by Standard and Poor's came out Dec. 13, in Bloomberg's London columnist's story, "GM, GMAC Derivatives Bet May Unravel." He pointed out that, with no buyer for GMAC on the horizon—all those who came near fell out—the cost to GMAC to buy "insurance," i.e., the purchase of credit-default derivatives to hedge against losses, at \$200,000 in October, is now back up to \$500,000. The rise in GM's "premium" payments occurred, in part, because there were no buyers for GMAC, so traders stretched out the odds against loss or default.

Revive Civilization

When we measure the physical changes in standard of living and productivity of the populations of the Americas and Europe over the interval from the close of World War II until today, we see three successive patterns. We see, thus: a.) a long wave of continued growth in the Americas, and economic recovery in Europe, from the end of that war, until the assassination of U.S. President John F. Kennedy; b.) a clearly defined slowing of growth, despite the brilliant successes of the Kennedy space program, spreading from Harold Wilson's Britain, during the latter half of the 1960s; and, c.) a long wave of decline and collapse over the thirty-five-year period since the 1970s plunge into a "floating-exchange-rate" monetary system and shift into emphasis on substituting a "services economy" for productive economies.

If we measure things in monetary terms, rather than physical realities, we have a contrary picture, a picture of soaring monetary expansion. In late 1995 and early 1996, I illustrated this seemingly paradoxical situation in what I named my "Triple Curve" function, showing soaring numbers for monetary and financial aggregates, but an accelerated rate of decline in net physical output per capita and per square kilometer (**Figure 1**). In 1999-2000, I showed a modified situation, in which accelerating physical collapse in the economies of the Americas and Europe, was matched by the absolutely dominant role of financial derivatives (**Figure 2**). Now, we have entered the general breakdown-phase of the process of

economic corruption which began with the globally radiating, 1964-68 effects of the first Harold Wilson government of the United Kingdom.

Clearly, the Bush-Cheney Administration—or, should we not say, "the Cheney-Bush Administration"—did not cause this forty-year collapse of the economies of the Americas and Europe. What they have done, amounts, in effect, to an attempt to drain the sinking economic ship by detonating a hole in its bottom.

Generational trend-changes in economy are a common fact of history. The trend of raging hatred of the "68ers" against "blue collar" industrial and agricultural operatives, was the political driver used by the Nixon Administration and Brzezinski's Trilateral Commission to push through that shift from productive to "service" economy, which provided the social mass-base for the policies of practice which have ruined the American and European economies over the recent forty years. It is the generation of young adults, as only typified by the LaRouche Youth Movement (LYM), which must now supply the energy needed to free the world from forty years of failure.

Members of the older generation represented within the ranks of the elected officials and staffs of the U.S. Congress, must now lead in putting the nation's policies back onto the road of economic recovery; but, it is that passionate desire to create a better future for humanity which the young-adult generation supplies, on which the Congress will rely for the mass-based impetus on which the success of the Congress's bipartisan collaboration will depend.

The combination, in this issue of *EIR*, of my featured presentation of the science-driver principles of economic recovery and the accompanying contributions of the LYM, lend needed substance to the virtual "New Tennis Court Oath" heralded by Representative Nancy Pelosi in her celebrated recent Harvard address, and in Bill Ford's letter on the challenge to today's automobile industry.

—Lyndon H. LaRouche, Jr.
December 17, 2005

FIGURE 1

LaRouche's Typical Collapse Function

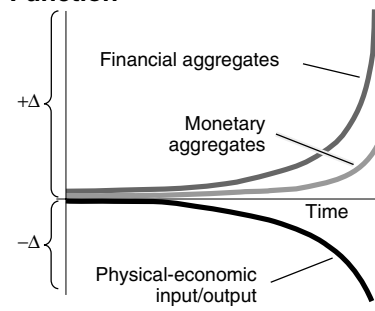
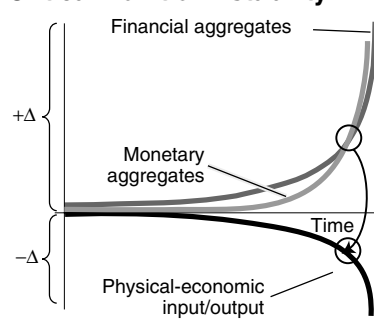


FIGURE 2

The Collapse Reaches a Critical Point of Instability



SEE LAROCHE ON CABLE TV

All programs are *The LaRouche Connection* unless otherwise noted. (*) Call station for times.

INTERNET

- ACCESSPHOENIX.ORG
Click *Live Webcast*
Fri: 6 pm
(Pacific Time only)
- BCAT.TV
Click *BCAT Live Stream for Ch. 35/68*
Mon: 9 pm
(Eastern Time only)
- DCTV.ORG
Click *Stream Video*
Sat: 11 am
(Mountain Time only)
- LAROCHEPUB.COM
Click *LaRouche Writings*
(Available 24/7)
- SCANTV.ORG
Click *Scan Web*
Wed: 4 pm
(Pacific Time only)
- WUWF.TV
Click *Public Access*
Click *Watch Ch.4*
Last Sat. Monthly
4:30 - 5 pm
(Eastern Time only)

ALABAMA

- BIRMINGHAM Ch.4
Wed: 11-11:30 pm
- UNIONTOWN Ch.2
Mon-Fri: every 4 hrs.
Sun: Afternoons

ALASKA

- ANCHORAGE Ch.44
Thu: 10 pm

ARIZONA

- PHOENIX Ch.98
Fri: 6 pm
- PHOENIX VALLEY
Quest Ch.24
Fri: 6 pm

ARKANSAS

- CABOT Ch.15
Daily: 8 pm

CALIFORNIA

- BEVERLY HILLS
Adelphia Ch.37
Wed: 4 pm
- BREA Ch.98
Thu: 6:30, 10:30 pm
- CARLSBAD
Adelphia Ch.3
1st/3rd Wed: 10 pm
- CLAY/CONCORD
Comcast Ch.26
2nd Tue: 7 pm
Astound Ch.31
Tue: 7:30 pm
- CONTRA COSTA
Comcast Ch.26
2nd Tue: 7 pm
- COSTAMESA
Comcast Ch.35
Wed: 10 pm
- E.LOS ANGELES
Adelphia Ch. 6
Mon: 2:30 pm
- HOLLYWOOD
Comcast Ch.24
Thu/Fri: 4-4:30 pm
- LANCASTER
- PALMDALE
Adelphia Ch.36
Sun: 1 pm
- LAVERNE Ch.3
2nd Mon: 8 pm
- LONG BEACH
Analog Ch.65/69
Digital Ch.95
4th Tue: 1-1:30 pm
- LOS ANGELES
Adelphia Ch. 98
Wed: 3-3:30 PM

- MARINA DEL REY
Adelphia Ch.98
Wed: 3-3:30 pm
Comcast Ch.24
Thu & Fri: 4 pm
- MIDWILSHIRE
Comcast Ch.24
Thu/Fri: 4-4:30 pm
- N.ORANGE COUNTY
Adelphia Ch.95/97/98
Fri: 3:30-4 pm
- N.SANDIEGO CTY
TimeWarner Ch.19
Wed: 6 pm
- NE SAN.FDO.VLY.
Comcast Ch.20
Tue: 4 pm
- OJAI
Adelphia Ch.10
Mon: 12:30 pm
- STA.CLAR.VLY.
T/W & Comcast Ch.20
Fri: 1:30 pm
- SANTA MONICA
Adelphia Ch.77
Wed: 3-3:30 pm
- TUJUNGA Ch.19
Mondays: 8 pm
- VENTURA CITY
Adelphia Ch.6
Mon: 7 am
Fri: 10 am
- VENTURA COUNTY
Adelphia/Comcast
Channels 8/16/25
Mon: 1 pm
- WALNUT CREEK
Comcast Ch.6
2nd Tue: 7 pm
Astound Ch.31
Tue: 7:30 pm
- W.HOLLYWOOD
Adelphia Ch.3
Wed: 4 pm
- W.SAN FDO.VLY.
TimeWarner Ch.34
Wed: 5:30 pm

COLORADO

- DENVER
Comcast Ch.57
Sat: 11 am

CONNECTICUT

- GROTON—Ch.12
Mon: 5 pm
- MANCHESTER Ch.15
Mon: 10 pm
- MIDDLETOWN Ch.3
Thu: 5 pm
- NEW HAVEN Ch.29
Sun: 4 pm
Wed: 7 pm
- NEWTOWN
Cablevision Ch.21
Mon: 9:30 pm
Thu: 11:30 am

FLORIDA

- ESCAMBIA
Cox Ch.4
Last Sat Monthly
4:30-5 pm

IDAHO

- MOSCOW Ch.11
Mon: 7 pm

ILLINOIS

- CHICAGO Ch.21
Comcast/RCN/WOW*
- PEORIA COUNTY
Insight Ch.22
Sun: 7:30 pm
- QUAD CITIES
Mediacom Ch.19
Thu: 11 pm

IOWA

- QUAD CITIES
Mediacom Ch.19
Thu: 11 pm

KENTUCKY

- BOONE/KENTON
Insight Ch.21
Sun: 1 am
Fri: Midnight
- JEFFERSON
Insight Ch.98
Fri: 2-2:30 pm

MAINE

- PORTLAND
TimeWarner Ch.42
Tue: 1 & 6 pm

MARYLAND

- ANNE ARUNDEL
Annapolis Ch.76
Milleneum Ch.99
Sat: 12:30 am
Sun: 12:30 pm
Tue: 6:30 pm
- MONTGOMERY
Comcast Ch.21
Mon: 11 pm
Fri: 3:30 pm
- P.G. COUNTY
Comcast Ch.76
Tue: 3 pm

MASSACHUSETTS

- BRAintree
Comcast Ch.31
BELD Ch.16
Tue: 8 pm
- CAMBRIDGE
Comcast Ch.10
Thu: 4 pm

MICHIGAN

- BYRON CENTER
Comcast Ch.25
Mon: 2 & 7 pm
- CALHOON
Comcast Ch.11
Mon: 4 pm
- DEARBORN
Comcast Ch.16
Zajak Presents
Mon: 6-8 pm
- DEARBORN HTS.
Comcast Ch.18
Zajak Presents
Mon: 6-8 pm
- KALAMAZOO
Charter Ch. 20
Thu: 11 pm
- KENT COUNTY
Comcast Ch.25
Fri: 1:30 pm
- N.KENT COUNTY
Charter Ch.22
Wed: 3:30 & 11 pm
- LAKE ORION
Comcast Ch.65
Mon/Tue: 2 & 9 pm
- LIVONIA
BrightHouse Ch.12
Thu: 4:30 pm
- MT.PLEASANT
Charter Ch. 3
Tue: 5:30 pm
Wed: 7 am
- SHELBY TWP.
Comcast Ch.20
WOW Ch.18
Mon/Wed: 6:30 pm
- WAYNE COUNTY
Comcast Ch.68
Unscheduled pop-ins
- WYOMING
Comcast Ch 25
Wed: 9:30 am

MINNESOTA

- ANOKA
Comcast Ch.15
Thu: 3 & 9 pm
- CAMBRIDGE
US Cable Ch.10
Wed: 2 pm
- COLD SPRING
US Cable Ch.10
Wed: 6 pm
- COLUMBIA HTS.
Comcast Ch.15
Wed: 8 pm
- DULUTH Ch.20
Mon: 9 pm
Wed: 12 pm
Fri: 1 pm
- MINNEAPOLIS
TimeWarner Ch.16
Tue: 11 pm
- NEW ULM Ch.14
Fri: 5 pm
- PROCTOR Ch.12
Tue: 5 pm to 1 am
- ST.CLOUD AREA
Charter Ch.12
Mon: 9:30 pm
- ST.CROIX VLY.
Comcast Ch.14
Thu: 1 & 7 pm
Fridays—9 am
- ST.LOUIS PARK
TimeWarner Ch.15
Wed & Fri:
12 am, 8 am, 4 pm
- ST.PAUL
(city only)
Comcast Ch.15
Fri: 11 pm
- ST.PAUL
(North suburbs)
Comcast Ch.14
Mon: 7 pm
Tue: 3 & 11 am
- St.PAUL
(S&W suburbs)
Comcast Ch.15
Wed: 10:30 am
Fri: 7:30 pm
- S. WASHINGTON
Comcast Ch.14
Thu: 1:30 pm

MISSOURI

- ST.LOUIS
Charter Ch.22
Wed: 5 pm
Thu: 12 Noon

NEVADA

- WASHOE
Charter Ch.16
Thu: 2 pm

NEW HAMPSHIRE

- WALPOLE
Comcast Ch.8
Tue: 1-1:30 pm

NEW JERSEY

- MERCER COUNTY
Comcast*
TRENTON Ch.26
3,4 Fri: 6-6:30 pm
WINDSORS Ch.27
Mon: 5:30-6 pm
- MONTVALE/MAHWAH
Cablevision Ch.76
Mon: 5 pm
- PISCATAWAY
Cablevision Ch.22
Thu: 11:30 pm

NEW MEXICO

- ALBUQUERQUE
Comcast Ch.27
Thu: 4 pm

ANTHONY/SUNLAND

- TimeWarner Ch.15
Wed: 5:05 pm
- LOS ALAMOS
Comcast Ch.8
Wed: 10 pm
- SANTA FE
Comcast—Ch.8
Thu: 9 pm
Sat: 6:30 pm
- SILVER CITY
Conley Productions
Daily: 8-10 pm
- TAOS Ch.2
Thu: 7 pm

NEW YORK

- BRONX
Cablevision Ch.70
Fri: 4:30 pm
- BROOKLYN
TimeWarner Ch.35
Cablevision Ch.68
Mon: 9-9:30 pm
- CHEMUNG
TimeWarner Ch.1/99
Tue: 7:30 pm
- ERIE COUNTY
Adelphia Ch.20
Thu: 10:35 pm
- IRONDEQUOIT
TimeWarner Ch.15
Mon/Thu: 7 pm
- JEFFERSON
LEWIS
TimeWarner Ch.99
Unscheduled pop-ins
- NIAGARA COUNTY
Adelphia Ch.20
Thu: 10:35 pm
- ONEIDA
TimeWarner Ch.99
Thu: 8 or 9 pm
- PENFIELD Ch.15
Penfield Comm. TV*
- QUEENSBURY Ch.71
Mon: 7 pm
- RIVERHEAD Ch.20
Thu: 12 Midnight
- ROCHESTER Ch.15
Sat: 4 pm; Wed: 9 pm
- ROCKLAND Ch.76
Mon: 5 pm
- STATEN ISL.
TimeWarner
Thu: 11 pm (Ch.35)
Sat: 8 am (Ch.34)
- TOMPKINS COUNTY
TimeWarner Ch.13
Alt Sun: 10 am & 4 pm
- TRI-LAKES
Adelphia Ch.2
Sun: 7 am, 1 pm, 8 pm
- WEBSTER Ch.12
Wed: 9 pm

NORTH CAROLINA

- HICKORY
Charter Ch.3
Tue: 10 pm
- OHIO
• CUYAHOGA
Adelphia Ch.21
Wed: 3:30 pm
- OBERLIN Ch.9
Tue: 7 pm

OREGON

- LINN/BENTON
Comcast Ch.29
Tue: 1 pm
- PORTLAND
Tue: 6 pm (Ch.22)
Thu: 3 pm (Ch.23)

RHODE ISLAND

- E.PROV. Ch.18
Tue: 6:30 pm
- STATEWIDE
RI Interconnect
Cox Ch.13
Tue: 10:10:30 am

TEXAS

- DALLAS
AT&T Ch.13-B
Tue: 10:30 pm
- EL PASO COUNTY
TimeWarner Ch.15
Wed: 5:05 pm
- HOUSTON
TimeWarner Ch.17
TV Max Ch.95
Wed: 6 pm
Sat: 9 am
12/21: 8 pm
12/23: 3-5 pm
- KINGWOOD
Cebridge Ch.98
Wed: 9 pm
Sat: 9 am
12/21: 8 pm
12/23: 3-5 pm

UTAH

- SEVIERE
- SANPETE
Centracom Ch.10
Sun/Mon: 6 & 9 pm

VERMONT

- GREATER FALLS
Adelphia Ch.10
Mon.Wed.Fri: 1 pm
- MONTPELIER
Adelphia Ch.15
Tue: 9 pm
Wed: 3 pm

VIRGINIA

- ALBERMARLE
Adelphia Ch.13
Fri: 3 pm
- ARLINGTON
Comcast Ch.33
Mon: 1 pm
Tue: 9 am
- CHESTERFIELD
Comcast Ch.6
Tue: 5 pm
- FAIRFAX Ch.10
1st Wed: 1 pm
- LOUDOUN
Adelphia Ch.23
Wed: 6 pm
- ROANOKE Ch.19
Tue: 7 pm
Thu: 2 pm

WASHINGTON

- KING COUNTY
Comcast Ch.29/77
Wed: 4 pm
- TRI CITIES
Ch.12/13/99
Mon: 12 Noon
Thu: 8:30 pm

WISCONSIN

- MADISON Ch.4
Tue: 1 pm monthly

WYOMING

- GILLETTE
Bresnan Ch.31
Tue: 7 pm

If you would like to get *The LaRouche Connection* on your local cable TV system, please call Charles Notley at 703-777-9451, Ext. 322. For more information, visit our Website at <http://www.larouchepub.com/tv>

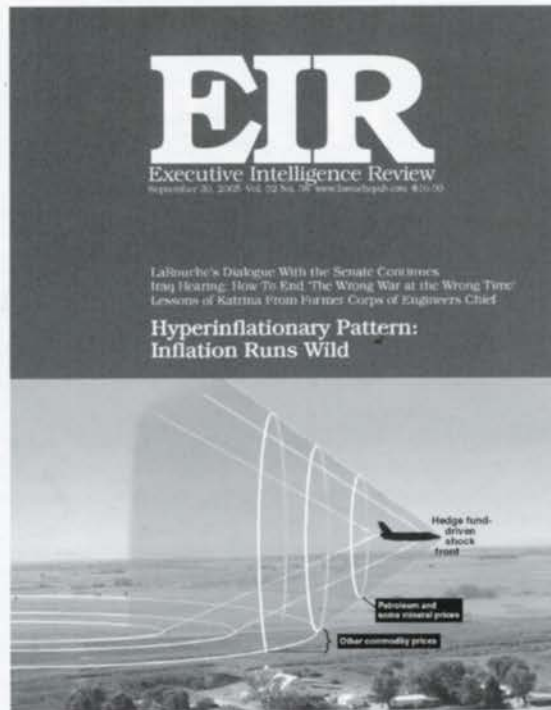
SUBSCRIBE TO

EIR

Executive Intelligence Review
EIR Online

EIR

gives subscribers one of the most valued publications for policymakers—the weekly journal that has established Lyndon LaRouche as the most authoritative economic forecaster in the world today.



EIR Online

issued every Monday, includes early access to most of the print magazine, as well as fast-breaking communications from LaRouche, up-to-the-minute world news, and a special historical feature.

I would like to subscribe to **Executive Intelligence Review**

U.S.A. and Canada:

- \$396** for one year
- \$225** for six months
- \$125** for three months

SPECIAL OFFER

- \$446** for one year
EIR Print plus EIR Online*

Outside U.S.A. and Canada:

- \$490** for one year
- \$265** for six months
- \$145** for three months

SPECIAL OFFER

- \$540** for one year
EIR Print plus EIR Online*

Standard Class shipping. Please call for First Class rates.

I would like to subscribe to **EIR Online***

- \$360** for one year
- \$60** for two months

EIR Online can be reached at:

www.larouchepub.com/eiw

Call **1-888-347-3258** (toll-free)

Name _____

Company _____

Address _____

City _____ State _____ Zip _____ Country _____

Phone (_____) _____ E-mail address* _____

* E-mail address required for EIR Online subscriptions

I enclose \$ _____ check or money order

Make checks payable to

EIR News Service Inc.

P.O. Box 17390, Washington, D.C. 20041-0390

Please charge my MasterCard Visa

Card Number _____

Signature _____

Expiration Date _____