

EIR

Executive Intelligence Review

September 22, 2006 Vol. 33 No. 38 www.larouchepub.com \$10.00

LaRouche Demands Impeachment of Bush, Cheney
Behind ABC's 9/11 Docudrama: The Axis of YWAM
Mexican Youth Say, 'The Republic Requires a Renaissance'

Eurasian Development: A Dialogue With LaRouche

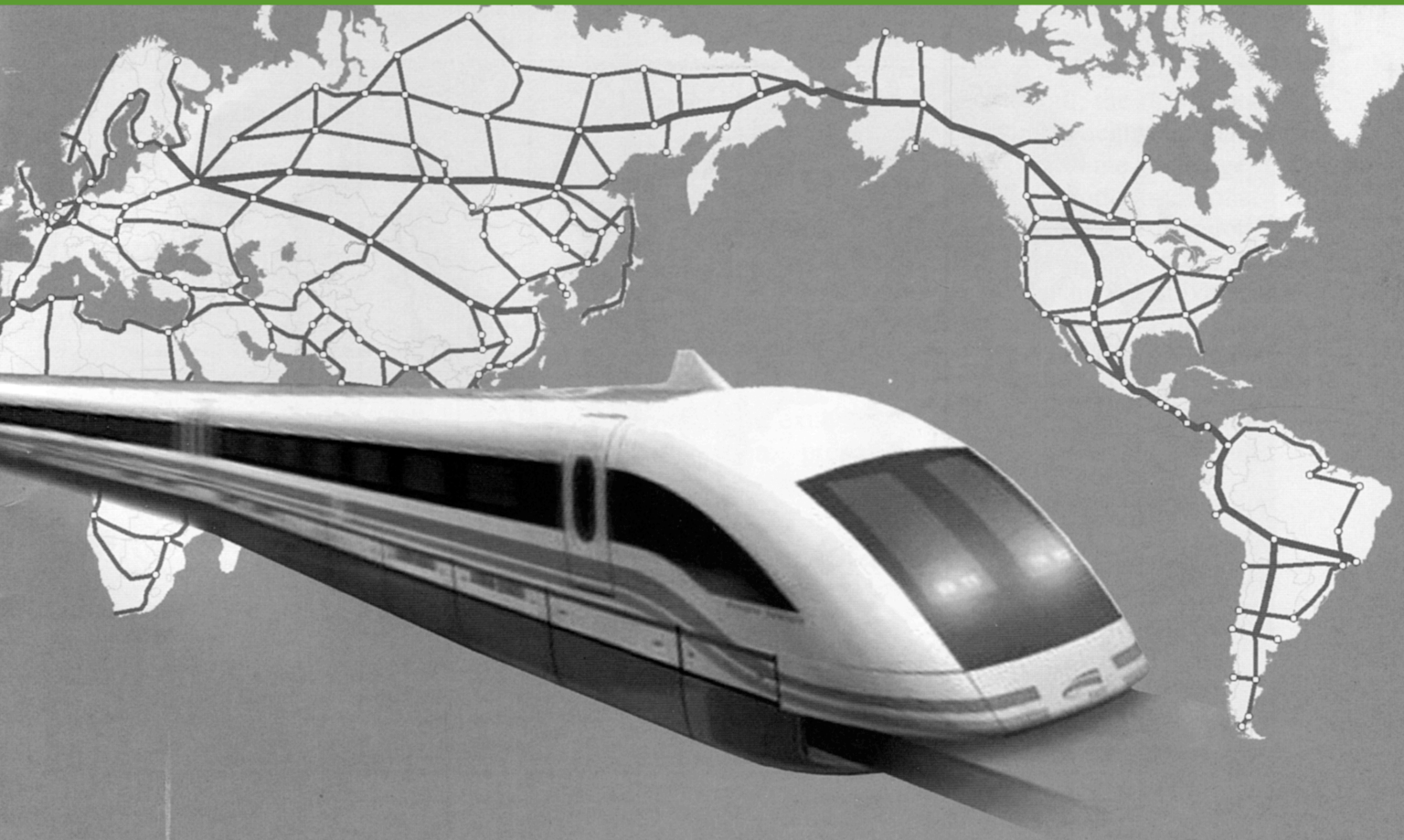

No to the 'Clash of Civilizations'!

The Anglo-American financier oligarchy is trying to unleash a "Clash of Civilizations," to block the vast potential for Eurasian development. Instead, the Western powers should join in the great project of the new millennium, the Eurasian Land-Bridge.

The Eurasian Land-Bridge

The 'New Silk Road'—locomotive for
worldwide economic development

including studies of:

- High-technology infrastructure development corridors
- China and Europe as Eurasia's development poles
- Crucial infrastructure projects in China
- The Eurasian Land-Bridge and development around the great ocean basins
- Financing an economic miracle: Hamiltonian credit generation
- The Eurasian Land-Bridge and the economic reconstruction of the United States



EIRNS

Helga Zepp-LaRouche (right), known as "the Silk Road Lady," has played a major role in organizing worldwide support for the Eurasian Land-Bridge. She is shown here with Schiller Institute associates at Lianyungang Port in China, October 1998.



A special report
from
**Executive
Intelligence
Review**

260 pages **\$200**

EIR News Service

P.O. Box 17390 Washington, D.C. 20041-0390 Phone (toll-free): 1 888 EIR-3258

ORDER ONLINE at www.larouchepub.com

Founder and Contributing Editor:

Lyndon H. LaRouche, Jr.

Editorial Board: *Lyndon H. LaRouche, Jr.,
Muriel Mirak-Weissbach, Antony Papert, Gerald
Rose, Dennis Small, Edward Spannaus, Nancy
Spannaus, Jeffrey Steinberg, William Wertz*

Editor: *Nancy Spannaus*

Associate Editors: *Ronald Kokinda, Susan Welsh*

Managing Editor: *John Sigerson*

Science Editor: *Marjorie Mazel Hecht*

Technology Editor: *Marsha Freeman*

Book Editor: *Katherine Notley*

Photo Editor: *Stuart Lewis*

Circulation Manager: *Stanley Ezrol*

INTELLIGENCE DIRECTORS:

Counterintelligence: *Jeffrey Steinberg,*

Michele Steinberg

Economics: *Marcia Merry Baker,*

Lothar Komp

History: *Anton Chaitkin*

Ibero-America: *Dennis Small*

Law: *Edward Spannaus*

Russia and Eastern Europe:

Rachel Douglas

United States: *Debra Freeman*

INTERNATIONAL BUREAUS:

Bogotá: *Javier Almaro*

Berlin: *Rainer Apel*

Caracas: *David Ramonet*

Copenhagen: *Poul Rasmussen*

Houston: *Harley Schlanger*

Lima: *Sara Madueño*

Melbourne: *Robert Barwick*

Mexico City: *Rubén Cota Meza*

New Delhi: *Ramtanu Maitra*

Paris: *Christine Bierre*

Rome: *Paolo Raimondi*

United Nations, N.Y.C.: *Leni Rubinstein*

Washington, D.C.: *William Jones*

Wiesbaden: *Göran Haglund*

*EIR (ISSN 0273-6314) is published weekly (50 issues),
by EIR News Service Inc., 912 Pennsylvania Ave., S.E.,
Washington, DC 20003.*

(703) 777-9451, or toll-free, 888-EIR-3258.

World Wide Web site: <http://www.larouchepub.com>

e-mail: eirms@larouchepub.com

European Headquarters: Executive Intelligence Review

Nachrichtenagentur GmbH, Postfach 2308,

D-65013 Wiesbaden, Bahnstrasse 9-A, D-65205,

Wiesbaden, Federal Republic of Germany

Tel: 49-611-73650.

Homepage: <http://www.eirna.com>

E-mail: eirna@eirna.com

Executive Directors: Anno Hellenbroich, Michael Liebig

In Montreal, Canada: 514-855-1699

In Denmark: EIR I/S, Sankt Knuds Vej 11, basement left,

DK-1903 Frederiksberg, Denmark. Tel.: +45 35 43 60 40,

Fax: +45 35 43 87 57. e-mail: eirdk@hotmail.com

In Mexico: EIR, Manuel Ma. Contreras #100, Despacho 8,

Col. San Rafael, CP 06470, Mexico, DF. Tel.: 2453-2852,

2453-2853.

*Copyright © 2006 EIR News Service. All rights reserved.
Reproduction in whole or in part without permission strictly
prohibited.*

Canada Post Publication Sales Agreement #40683579

Postmaster: Send all address changes to *EIR*, P.O. Box
17390, Washington, D.C. 20041-0390.

From the Associate Editor

The Sept. 6 Berlin-Washington webcast by Lyndon LaRouche, featured in last week's issue, sparked an intensive debate on both sides of the Atlantic. LaRouche has a backlog of hundreds of e-mails from people who have raised questions on foreign policy, the economic crisis, the future of the Democratic Party—you name it. This week, we publish a selection of those from international figures, along with LaRouche's replies. We also present the written contributions by a number of scientific and economic experts on matters of Eurasian economic and scientific development, which were submitted to the conference for LaRouche's evaluation. They provide a vivid idea of how closely LaRouche's words and actions are being studied in Russia, eastern Europe, and China, in particular.

We shall continue to publish more of this ongoing of dialogue, leading up to the next Berlin-Washington webcast, in late October.

In his remarks to the Sept. 6 event, LaRouche emphasized the necessity of impeaching both Bush and Cheney—a theme which he accentuates in a statement in this issue, and which is expanded in the *Editorial*. Some Democrats are worrying that they don't have their legal arguments lined up yet; they argue that it would be best to concentrate on gaining control of Congress in the elections, and then—if they succeed—moving toward impeachment. But leadership is required *now*. The Bush-Cheney team have committed scores of impeachable offenses! With the neo-cons beating the drums for war against Iran; the U.S. auto industry in free-fall; the real estate bubble deflating rapidly, there is no time to lose in replacing “the gang that can't shoot straight” with leadership adequate to the challenges facing us. It is clear that a growing number of patriotic, traditional Republicans will get on board with a bipartisan effort in this direction.

With the November elections looming, ABC television ran its Bush League docudrama “The Path to 9/11.” Our investigative reporter Anton Chaitkin has discovered who was behind it: the networks spawned by the late, explicitly pro-Nazi, Frank Buchman. See *National*.

Finally, don't miss the exuberant program for Mexico's National Democratic Convention, prepared by the LaRouche Youth Movement.

Susan Welsh

EIR Contents

Cover This Week

A proposal for the Eurasian Land-Bridge to cross the Bering Straits, extending rail transport into the Americas.



EIRNS and Hal Cooper

- 4 A Eurasian Dialogue with LaRouche on Economic Progress**
We continue our coverage of Lyndon LaRouche's Sept. 6 Berlin-Washington webcast, with written contributions submitted from Russia and China, and e-mail exchanges with international leaders following the conference.
- 6 Dialogue Continues by E-Mail After Berlin**
LaRouche responds to questions from Russia (Yuri Krupnov, Prof. Yelena Borisova, Sergei Usoltsev), Belarus (Yuri Tsarik), Armenia (Hrant Khachatryan), and an editor from China.
- 9 Global and Regional Dimensions of the SCO**
By Prof. S.G. Luzyanin, Far East Institute of the Russian Academy of Sciences.
- 11 The SCO and 50-Year Development Prospects**
By R.G. Tomberg, Center for External Economic Research, Russian Academy of Sciences.
- 12 Primakov Issues Book on Mideast Prospects**
Vladimir B. Isakov, an associate of former Russian Prime Minister Yevgeni Primakov, sent this statement made by Primakov at a press conference launching his new book, *Confidential: The Middle East in the Spotlight, and Behind the Scenes*.
- 14 Support for LaRouche's Long-Term Perspective**
By Prof. O.L. Kuznetsov and Prof. B. Ye. Bolshakov, Dubna University of Nature, Society, and Man, Russia.
- 15 Nuclear Energy and Sustained Development**
By Dr. Stanislav Subbotin, Kurchatov Institute, Moscow.
- 18 Can We Establish a New Bretton Woods?**
By Prof. Dai Lunzhang, China International Economic Relations Society.

National

20 **LaRouche Demands Immediate Impeachment of Bush, Cheney**

“We see a pattern of habitual lying on the part of the President and Vice President. This constitutes more than sufficient grounds for impeachment,” LaRouche said on Sept. 11.

21 **Committee Finds No Saddam-al-Qaeda Link**

From a Senate Select Committee on Intelligence report dealing with allegations of Iraqi links to al-Qaeda.

22 **Documentation: ‘A Devastating Indictment’**

Excerpts from statements to the U.S. Senate by Sen. Carl Levin (D-Mich.) and Sen. Jay Rockefeller (D-W.Va.)

25 **Behind the ABC 9/11 Docudrama: The Axis of YWAM**

An investigation of “Youth With A Mission,” the religious cult that cooked up ABC television’s “The Path to 9/11,” a docudrama filled with lies. YWAM’s origins—though they don’t admit it—are with the late pro-Nazi Frank Buchman and the Moral Rearmament crusade.

29 **YWAM Celebrates Founder Frank Buchman**

30 **Congressional Closeup**

International

32 **Iran: Turning the Tables on the War Party**

Both the Iranian government and the International Atomic Energy Agency (IAEA) are rebuffing and refuting the belligerence of the neo-cons.

Economics

36 **Ford Is Repeating Delphi’s Destruction As Auto Sales Fall**

Congress will have to act to stop the destruction of America’s vital machine-tool sector.

38 **U.S. Electric Grid Is Reaching the End Game**

43 **Drive Your Car and Starve! U.S. Corn Belt Shifts to Ethanol**

45 **One Year After Katrina, Huge Rebuilding Task Remains**

50 **China’s ‘Western Development’ Spurs Growth of the Eurasian Land-Bridge**

53 **Superconductivity Conference: Seattle LYM Conduct Between the Notes**

Members of the LaRouche Youth Movement attended the Applied Superconductivity Conference in Seattle, Washington, Aug. 27-Sept. 1.

Youth Movement

56 **The Mexican Republic Requires a Renaissance**

A conceptual proposal for the National Democratic Convention presented by the LaRouche Youth Movement in Mexico.

Editorial

72 **Throw the Bums Out**

A Eurasian Dialogue with LaRouche on Economic Progress

Sept. 6, 2006 marked the beginning of a new phase of public international dialogue between American economist and statesman Lyndon LaRouche, and leading political and scientific personalities in the countries of Eurasia, in particular, on the crucial questions of international economic development over the next 50 years. This in-depth discussion began with LaRouche's webcast presentation from Berlin, Germany, and continued for approximately two and a half hours in that medium (see last week's *EIR*, and the webcast video at larouche.pac.com). The webcast was transmitted by videoconference to an audience gathered in Washington, D.C., and was watched over the Internet by people around the world.

But the process did not stop there. Many of the participants had studied a discussion paper issued by LaRouche three weeks earlier, entitled "Dynamics & Economy" (*EIR*, Aug. 25) along with other of his works on the impending international economic-financial breakdown crisis, and the alternatives available to overcome it, with special emphasis on the role of Eurasia. They submitted papers and comments in numbers too great to be encompassed in the Sept. 6 proceedings. In addition, many leading citizens who watched the webcast responded by sending in substantial questions and comments to LaRouche, some of which he has begun to answer as part of the public debate.

It is no exaggeration to say that this debate over the perspective to bring the world back from the brink of a New Dark Age, and into a new era of cooperation among sovereign nation-states for global economic development, is at the center of determining international politics today. There will be no derailing the current drive for chaos through war and economic disintegration, without a fundamental shift toward a new global system, based on proposals like the Eurasian Land-Bridge and the Peace of Westphalia, which LaRouche has championed. The dialogue which occurred around the Sept. 6 webcast already reflects discussion in some government circles, but it must be broadened and deepened so that it dominates international politics.

For this reason, Mr. LaRouche has announced that he will be holding another international webcast from Berlin in late October, with the aim of bringing in many more Eurasian participants. Once global agreement on a 50-year development perspective, such as that which he has put together, has been reached, LaRouche said, one of the first tasks that will

Participants in Berlin Dialogue

Contributions were received from many nations which could not be mentioned at the Berlin event for lack of time, including: Czech Republic, Croatia, Macedonia, Bosnia-Herzegovina, Belarus, Poland, Spain, Great Britain, Argentina, and Iran.

A greeting was sent from **Dr. Mahathir Mohamad**, former Prime Minister of Malaysia.

Questions and comments from U.S. institutional figures, which appeared in last week's *EIR*, were not identified by name.

The following are in order of mention during the proceedings:

Prof. Sergei G. Luzyanin, Institute of the Far East, Russian Academy of Sciences, president of the Foundation for Eastern Studies at the Moscow State Institute for International Relations, a specialist on the Shanghai Cooperation Organization and Central Asian security.

Prof. R.G. Tomberg, Center for External Economic Research, Institute of Economics, Russian Academy of Sciences, Moscow.

Prof. Ma Jiali, research professor at the China Institute of Contemporary International Relations, a leading

have to be taken up is the development of Africa, as a joint project of Eurasia and the Americas.

In the meantime, *EIR* will be circulating the products of this dialogue, and some of the ongoing correspondence between LaRouche and his interlocutors. We begin in this issue, by publishing some of the papers and comments received, in some cases with Mr. LaRouche's responses. We anticipate that the reproduction of this dialogue will be an ongoing feature of our weekly coverage.

What About the United States?

Many of our readers will naturally respond to this discussion with the question: What about the United States? LaRouche, of course, sees the organization of the Americas around a development perspective, as an urgent and necessary complement to the organizing of Eurasian development. But while the maintenance of Bush-Cheney control over the White House represents a mortal danger to both the United States', and the world's survival, there can be no successful replacement of this gang without the establishment of an institutional policy commitment, within leading circles in the U.S. and around the world, to a perspective of economic development such as was discussed on Sept. 6, and in its aftermath.



EIRNS/Helene Möller

Lyndon LaRouche addresses the Berlin-Washington webcast on Sept. 6. He emphasized a 50-year development perspective for Eurasia—with advanced technology and physical infrastructure—not money! “Forget the illusion that money has any intrinsic value. . . . Money is simply an agreement.”

In October 1988, LaRouche's press conference in Berlin, where he forecast the collapse of the Soviet economy and the re-emergence of Berlin as the capital of a reunified Germany, was proved historic in hindsight—when events fulfilled his forecast over the next few years. LaRouche's webcast of Sept. 6, 2006 is already historic in its implications, given the caliber and quality of the deliberations there carried out. And so, on to the dialogue.

expert in China on India and Indian-Chinese relations (the CICIR is a Chinese government strategic think-tank).

Dr. Phillip Jenninger, former president of the German Parliament.

Prof. Dai Lunzhang, former chief economist of the Central Bank of China, first vice president of the China International Economic Relations Society. One of China's leading experts in banking and finance. Coauthors of his paper were **Dr. Zhang Yun** and **Dai Jun**, MA in international relations.

Dr. Su Jingxiang, director of the Center for Globalization Studies at the China Institute of Contemporary International Relations.

Vladimir B. Isakov, vice president of the Chamber of Commerce and Industry of the Russian Federation, with greeting to conference and submission of text of a speech by former Russian Prime Minister **Yevgeny Primakov**, president of the Chamber.

Prof. Seyyed Mohammed Selim, professor of Political Science, Cairo University, Egypt.

Dr. Mahmood Khallaf, retired general, Nasser Military Academy, Egypt

Gen. Mirza Anam Beg, former Chief of Staff of Army of Pakistan.

Dr. Stanislav Subbotin, nuclear energy expert at Russia's Kurchatov Institute, coauthor together with Kurchatov Institute President Yevgeny Velikhov of a book on the

future of world nuclear energy.

Academician Dmitri V. Rundqvist, president of Russian Society of Mineralogy, director of the Vernadsky State Geological Museum of the Russian Academy of Sciences, Moscow.

Col. Chaman Datta, Foreign Policy Association (U.S.A.), president of the Indian Veterans Officers Association of America.

Prof. Oleg L. Kuznetsov, president of the Russian Academy of Natural Sciences and rector of Dubna University, together with **Prof. Boris E. Bolshakov**, of Dubna University.

Yuri V. Krupnov, chairman of the Supervisory Council of the World Development Institute, chairman of Organizing Committee for a Constituent Congress of the Party of Development, rector of the Youth Nuclear Academy, Moscow.

Dr. Friedhelm Krueger-Sprengel, former Ministerial Director of German government, consultant of law and honorary president of the International Society for Military Law and the Law of War.

Nina V. Gromyko, Institute of Innovative Strategies for General Education, Department of Education, City of Moscow.

Daniel Buchmann, mayoral candidate of the Civil Rights Movement Solidarity (BüSo) in the Sept. 17 state elections in Berlin.

Dialogue Continues by E-Mail After Berlin

Of the many questions and comments that came in to the Berlin webcast both before and during the Sept. 6 event, from international scientists, political leaders, and others, the following were answered by Mr. LaRouche after the webcast, by e-mail, as of Sept. 12.

Russia

Yuri Krupnov, chairman of the Organizing Committee to Prepare, Convoke, and Conduct a Constituent Congress of the Party of Development; chairman of the Supervisory Council of the World Development Institute Moscow, Sept. 5 (translated by *EIR*):

Dear Mr. LaRouche,

First of all, allow me to express my gratitude for your tireless work in the interest of all humanity, on organizing world development. Today Russia knows you well, as an outstanding economist and political figure of our day, a genuine leader for mankind. We wish you strong health; in Russia we often talk about a "Siberian constitution" and the longevity of the Caucasus.

We fully share your concern over global deindustrialization, and we believe that it is necessary to organize a world coalition for industrial development, right away. Only through the decisive development of advanced industry, together with the development of education and science, will it be possible to save the world from a fatal global monetary and financial crisis, and from permanent world war, and provide a decent life for the peoples of the world.

The Party of Development, which is currently being created in Russia, has begun to organize a Russian coalition for industrial development. What would you think about our organizations, yours and ours, jointly undertaking to create a world coalition for industrial development?

Respectfully yours,

Yuri V. Krupnov

LaRouche: I welcome your suggestion of cooperation. I illustrate my view of that matter by the following observations.

The mission, as I see it presently, has the following principal parameters.

1. National sovereignty as the cultural foundation of the development of the creative mental powers of a people through use of the shared ironies of their cultural legacy.

2. Understanding of the functional distinctions of, and interconnections among the abiotic, Biosphere, and Noösphere domains of physical action.

3. The related present division of labor defined by the

uneven and unequal developments among various sections of the planet, up to the present time.

4. The understanding of the role of, and need to foster, the development of those potentials of the human individual which are lacking in the lower forms of life. The role of cultures and their development in seeking a state of parity among cultures of differing prior histories of experience and related development. The promotion of the sense of an immortality unique to the members of the human species, as the motivating impulse for progress in mankind's role in the universe.

5. The mission of increasing the physical well-being and productivity of successive generations of populations, as measurable per capita and per square kilometer of area.

6. The presently urgent necessity of seeing man in his emerging creative role in the Solar System and beyond as the destiny of our species.

7. The mastery of the theoretical and practical function of the conception of dynamic processes in life in general and in the appropriate management of economies and their development.

8. The clarification of the respective, interdependent roles of capital improvements in basic economic infrastructure and of production of particular goods, in the management of the boundary conditions within both national economies and life on our planet as a whole.

When those and related considerations are taken into account, it appears to me that the proper orientation for relations among nations and peoples of our planet is, at least approximately, the following.

There are three principal zones of close cooperation among sovereign nation-states of the planet. These are, principally, the obvious, functional categories of Eurasia, the Americas, and Africa.

The pivotal feature of mission-orientation among the regions within those continental systems is very long-term physical-capital investment in essential basic economic infrastructure. This provides the stimulant and basis for development of industries around the realization of the needed development of infrastructure. These two considerations provide the platform on which the increase of the physical productive powers of labor through scientific and technological progress may be organized efficiently.

The cooperation of the developing continents of Eurasia and the Americas in providing necessary assistance for the equitable development of the presently raped continent of Africa, affords mankind in general a sense of both a moral and a practical goal for the participating role of development within all of the continents and comparable smaller regions.

The essential moral issue posed to statecraft today, is the need to rise above negative definitions of rival self-interests, to the Westphalian Principle: the urgency of satisfying the meeting of the interests of the other. It is not relief from pain which motivates the human personality, but the joy of participating in promoting a better quality of the outlook and conduct of future generations within our species at large.



Courtesy of Yuri Krupnov

Yuri Krupnov proposes that the LaRouche movement join with his Party of Development "to undertake a world coalition for industrial development."

We have come to the end of a time when warfare was considered a standard for crafting strategy. Today, when the sheer destructive effect of asymmetric warfare destroys so-called conventional warfare practices, prevention of avoidable warfare is the obvious priority. Better than preventive action of such obvious forms, is changing the physical-economic and cultural environment through intended effects upon the passions of high rates of scientific-technological progress, especially fundamental scientific progress: a complementary way of expressing the "Westphalian Principle."

The points so arrayed are intended to suggest the needed rich opportunities for change in the prevalent strategies of our planet.

—Lyndon

Prof. Yelena Borisova, Moscow, coordinator of the Anti-Globalist Resistance, Sept. 6 (translated by *EIR*):

The Second All-Russian Forum of Anti-Globalists adopted the Leningrad Charter, "An Answer to the Challenges of the 21st Century." It includes a call, based on the works of Mr. LaRouche, to restrict the sale of financial derivatives and change the world monetary system. Also included are points on the need to ban advertising (except in specialized publications), and several others. How realistic do you think it is for your and our proposals to be implemented, under current conditions? How can this be accomplished?

LaRouche: The excitement of the creative potentials of the generation which must carry the mission of the coming two generations—of the coming fifty years—is crucial.

Since the death of U.S. President Franklin Roosevelt, the dominant trend in the Americas and Europe, in particular, has been a post-1945 cult of Sophistry akin to that which led the Greece of Pericles into its self-destruction, through its crimes against the people of Melos, into the full spread of the Peloponnesian War. We must reverse that kind of effect which

has ruined the hopes we had at the close of the defeat of Hitler's forces.

Presently, I am pushing for the immediate reproduction of the Sept. 6th event, including a DVD. The point is to promote the discussion of that event and its preparations, in preparing for a new Berlin-Washington, D.C. event for very late October, or very early November. I hope to foster the growth of the discussion process to the degree needed to make this useful for discussions within and among governments.

—Lyndon

Sergei Usoltsev, Moscow Ye.L. Shiffers Institute for Advanced Studies, Sept. 6 (translated by *EIR*):

Dear Mr. LaRouche,

A key point of your program for a way out of the systemic world crisis is the world infrastructure development project, known as the Eurasian Land-Bridge. John Perkins' popular book, *Confessions of an Economic Hit Man*, however, makes clear that infrastructure projects may act not only as a means of developing a country, but sometimes rather as a way to loot and enslave a country. In this connection, I would like you to explain your position on the following questions:

1. Do you think that the strategic partnership between the U.S.A. and Saudi Arabia ought to be taken as a model for international cooperation?

- If yes, what are the benefits that will accrue to each side in the long term (25-50 years)? Won't the result be, that a country entering into partnership with the U.S.A. will end up with no means to pay for maintaining its infrastructure, such that it will be forced to bargain, using its long-term capabilities (i.e., to make decisions favorable for the U.S.A., though they harm the partner country's ability to develop)?

- If no, then what are the fundamental flaws in the "U.S.A.-Saudi Arabia" model of international cooperation and in the infrastructure projects that have been built within the framework of this model? How does your alternative propose to eliminate any shortcomings that you would identify?

2. Does your long-term economic development program necessarily presume the continuation (for natural reasons, or political ones) of U.S. and Western European technological leadership (i.e., that these countries will possess the most advanced technologies, in the historical long term) and technological domination by these countries (i.e., that these will be the countries that determine the rules and procedures for other countries to have access to various technological packages)? Or do you, rather, allow for the possibility that other countries will achieve technological leadership positions? If so, then what do they need to do, to make this happen? How do you propose to solve the problem of the uncontrolled emergence of superpowers (like the U.S.S.R., thanks to American aid in the 1920s and 1930s, or China, thanks to Soviet assistance in the 1940s and 1950s)? Or do you not see this as a problem?

LaRouche: Thank you for the questions.

1. I am treating the entire region affected by the legacy of

the Sykes-Picot arrangements (Southwest Asia) as a single phase-space now being plunged into a spreading form of escalating asymmetric warfare. No ordinary diplomatic negotiations, nation by nation, will accomplish much of durable value. There must be an approach to the entirety of the region; but, that must be situated within the global realities of the present threat of a mixture of terrible warfare and a general economic-breakdown-crisis planet-wide.

2. The emergence of modern European civilization, which occurred during the first half of the Fifteenth Century, produced both the commonwealth notion of the sovereign nation typified in practice by France's Louis XI and England's Henry VII, but also the forces of the reactionary Venetian financier-oligarchy that launched the Grand Inquisitor Tomás de Torquemada, and a virtually global form of anti-Semitism and killing of Muslims like that which Venice and the Norman chivalry had launched in the effort to uproot the civilizing legacy of Charlemagne's system.

However, the included net result was the eruption of modern experimental science by Nicholas of Cusa and such of his professed followers as Luca Pacioli, Leonardo da Vinci, and Johannes Kepler. Since the religious wars of 1492-1648, European civilization has been internally divided between, chiefly, the neo-Venetian followers of Venice's Paolo Sarpi on the one side, and the legacy of Kepler, Leibniz, and the American Revolution on the opposing side. Nonetheless, despite that awful division within European culture, the progress of science and technology in the Cusa-Kepler-Leibniz-Gauss-Riemann tradition, as coupled with relics of the anti-oligarchical commonwealth conception of the sovereign nation-state, has given European culture a superior capacity for scientific and technological progress, a capacity which must be reawakened and harvested today.

On this account, Russia's development as a Eurasian culture with the attributes of the scientific development from Peter the Great's visits to Freiberg Academy through the role exemplified by Vernadsky, qualifies Russia to play the role of a Eurasian link between East and West. This link's development now, is crucial for the survival of civilized life on this planet today.

—Lyndon

Belarus

Yuri Tsarik, Minsk, chairman of the "Arks" Intellectual Club at Belarus State University, and an associate of the World Development Institute in Moscow, Sept. 5 (translated by *EIR*):

Since LaRouche's ideas, and especially the key questions of this conference, are of critical importance for Belarus, we decided to organize a Round Table on "New Opportunities for Russia's World Policy: the View from Berlin, Moscow, and Minsk."

Here is a question from conference participants in Belarus, where a round table is taking place at this time, on problems related to building a just world order, and a new



EIRNS/Muriel Mirak-Weissbach

Tun Dr. Mahathir Mohamad, former Prime Minister of Malaysia, sent the conference a message, via his aide, regretting that he could not attend due to other commitments. "He sends his apologies and regards to Mr. LaRouche."

world policy for Russia:

Mr. LaRouche, in the context of the discussion of how to get out of the economic and financial crisis, and how to preserve military and political stability, what economic, social, and political development perspectives could and should be proposed by Russia, as a potential Eurasian leader, as well as by Germany and other leading powers in the region, for the countries of Central and Eastern Europe: that is, Belarus, Ukraine, Poland, Slovakia, the Baltic countries, etc.? Thank you.

LaRouche: Let us explore practical ways for accomplishing those objectives in a preliminary way. I have three short-term objectives for movement in that direction.

1. We shall be processing the product of the Berlin conference of Sept. 6th during the present week. This will result in a DVD production, in which the audio-visual product from the Berlin meeting will be supplemented by my response to questions which did not get into the three-hour limit on the Berlin-Washington, D.C. webcast event. That is intended to serve as discussion material for the next event.

2. We are planning a next Berlin event for either later October or very early November.

3. I presume that there will be discussion by mail and otherwise during the month and a half preceding the next Berlin webcast.

4. Also, there are politically tectonic ruptures to be expected planet-wide during this approximate interval.

Therefore, the U.S. participation, in that way, in discussion centered on relevant places in Eurasia, should draw in sufficient participation from various places and institutions, to provide governments with a fresh view of strategic options for this planet during the immediate months and years ahead.

I am most concerned with the development of a generation of young adults, now in the 18-25 and 26-30-year intervals, as the generation to lead over the duration of the coming fifty years. The self-development of leading representatives from that generation should be a focal point of reference. After all,

the purpose is to build the future; this suggests that the people who will be working over that interval are the generation to which the immediate goals, and self-development are assigned.

—Lyndon

Another question from **Yuri Tsarik**, Minsk, e-mailed during the webcast, Sept. 6:

A question from a group of students in Belarus. Mr. LaRouche, what perspectives and projects do you think should be proposed to the youth of European countries, so that the young people, out of a factor of social and political instability, could become a moving force of development of their countries and of world development? And what are the plans of the LaRouche Youth Movement in that connection? Thank you.

LaRouche: An actual solution for the presently escalating world crisis depends upon the degree we develop the needed qualities of leadership for the future, now, among the 18-30-year-old generation of young adults. I place special emphasis on a particular approach to mastery of the most crucial of the valid steps of progress in physical science since the ancient Pythagoreans (such as Archytas) and Plato, and approach the continuation of that history as modern science as typified by the span from Kepler through Riemann.

The present world crisis must take into account the deadly threat from the poverty of approximately three-quarters of the people of our planet. This requires a very high rate of increase of emphasis on basic economic infrastructure and production technology. This means that the limited number of qualified scientists working today is a great problem for mankind as a whole. We must build a generation of future leaders in progress from among a large part of the young adults in the age-interval between 18 and 30.

This must be done by placing emphasis on national sovereignty and national cultures, since the culture of a people is the basis on which the development of the creative powers of the great part of the entire population depends. Therefore, the approach must be based upon cooperation in common world goals through the promotion of the development of sovereign nationalities.

—Lyndon

Armenia

Hrant Khachatryan, Member of the Armenian Parliament:

Dear Mr. LaRouche,

Our best greetings to you from Constitutional Rights Union party of Armenia. Regional problems are becoming more dangerous with respect to the war in Lebanon. Your opinion please about future development around problems in the U.S., Europe, Russia, Iran, Syria, and Lebanon in this World-Historical Moment.

Best wishes,

Hrant Khachatryan

LaRouche: Thank you for the message. I would hope we

have the opportunity to meet again soon. There is much to discuss in the pursuit of a clearer understanding of the way in which to bring national cultures into the needed forms of cooperation.

—Lyndon

China

A Chinese editor: Since globalization goes so fast and most governments of the world are not fully prepared, would there be a global government in the near future? As I am going to Helsinki for the 6th Asia Europe Summit, I think of the possibility that influential world organizations such as ASEM and APEC would gradually emerge and form a kind of global government. Is it possible? Thank you.

LaRouche: It is not possible. “Globalization” is a recent name for what used to be called “imperialism”: the elimination of the sovereignty of the people, and the attempted establishment of a form of oligarchical society under whose rule most of the population is degraded to the life of an ignorant lower form of animal life, as under the ancient Babylonian, Roman, Byzantine, and medieval *ultramontane* forms of a pro-bestial oligarchical culture—in which the sovereignty of a people is outlawed by an empire, an empire such as the Anglo-Dutch Liberal system which came into being as the world-leading imperialist/oligarchical trend with the February 1763 Treaty of Paris.

—Lyndon

Russia

Global and Regional Dimensions of the SCO

by Prof. S.G. Luzyanin

Prof. S.G. Luzyanin is a senior scientific researcher from the Far East Institute of the Russian Academy of Sciences, working on current questions of the Shanghai Cooperation Organization (SCO) and security in Central Asia. He sent this paper, titled “The Shanghai Cooperation Organization (SCO); Its Development During 2006; Global and Regional Dimensions” (Aug. 24, 2006) to the Berlin conference, and it was summarized during the question period. For Mr. LaRouche’s comments on this and related questions, see last week’s EIR. Professor Luzyanin’s paper was preceded by an introductory note of greeting to the conference. Both have been translated here by EIR.

As for Mr. LaRouche’s proposals for large-scale infrastructure projects in Eurasia, I believe that his evalua-

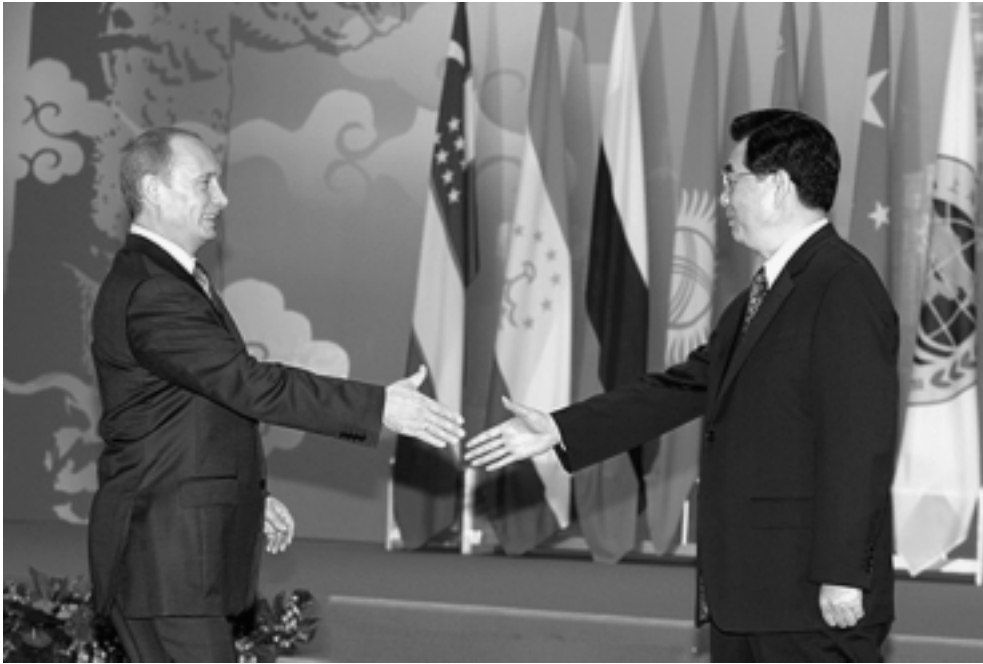

Press Service of the President of Russia

Russian President Vladimir Putin and Chinese President Hu Jintao meet at the Shanghai Cooperation Organization summit on Sept. 14, 2006.

tion and analysis of Eurasian matters are extremely important and timely at present. Essentially LaRouche's concept gives new approaches to the integration of the Eurasian space. The idea of the Eurasian Bridge precisely fits with traditional Russian approaches and is well suited to the current reality in the world: the formation of a new institution for organized cooperation among peoples and states. I believe that Mr. LaRouche, in developing the concept of the Eurasian Bridge, has found the optimal ratios of geopolitical, physical-geographical, and geo-economic methods. The result is a very promising theory of the fusion of various sciences. This is very important, since most studies are premised exclusively on political science methods. I fully support this approach that Mr. LaRouche takes, and his basic conclusions.

Respectfully, and with very best wishes,

Prof. S.G. Luzyanin

The Overall Story

The 5th anniversary summit of the Shanghai Cooperation Organization (SCO) (July 5-17, 2006, Shanghai, P.R.C.) confirmed that the organization is attractive and of interest for many countries of the East, which would like to live in a multipolar world, a world free of American dictates. The organization's prestige in the world is rising rapidly. An impressive line has already formed of applicants for membership in the SCO, including major countries such as India, Pakistan, Iran, and Mongolia, which have observer status. There is a special contact group working with Afghanistan. It is also known that Belarus and a number of other countries would

like to become observers. Many authoritative international organizations have already established cooperation with the SCO, or would like to do so. The Shanghai summit declared a moratorium on the further expansion of the organization. It appears that a status called "dialogue partner" will soon be established, as a position between observer and permanent member. The SCO leadership decided to call a halt to the headlong rush of new members to join, in order to allow for political and ideological "digestion" of what has already been established.

The SCO and the Problem of Detering the U.S.A.

The SCO's growing strength is pivoted on the Russian-Chinese strategic partnership, which is extrapolated to the organization as a whole. In addition to its basic objectives of fighting extremism, terrorism, and separatism, and developing economic and humanitarian cooperation in Central Asia, the SCO is objectively becoming an important factor for "detering" U.S. extremism. The Iraq adventure, the Lebanon-Israel war, and the hysteria around Iran have demonstrated once again the adventurism of U.S. policy and the need for politically building up alternative political organizations, like the SCO, in the world. Locally, the SCO today already represents a serious political counterweight to the U.S.A. in Eurasia.

Regional Specifics of the SCO

The SCO's internal structure, while noting that the consensus of all member states is required, can be thought of provisionally as "three (China, Russia, Kazakstan) plus three

(Uzbekistan, Kyrgyzstan, Tajikistan).” The first troika represents the clear leaders of the organization, which initiate various questions and decisions to be adopted by the organization as a whole. The creation of an “axis of democracy” from the Baltic to Georgia, and the “Greater Central Asia” (GCA) and other American projects, are prompting actions in response, by Moscow and Beijing, and will continue to do so. Vladimir Putin and Hu Jintao have been able, in the framework of the unified SCO project, to offer the Central Asia region their agenda of security, development, and modernization. This agenda is attractive for the local elites, because it does not propose a radical “democratization” of the existing regimes, according to the well-known American scenario. Rather, it fully supports them and provides an opportunity for the more underdeveloped countries (Tajikistan, Kyrgyzstan, Uzbekistan) to enjoy economic development, based on the resources of the more developed ones: China, Russia, and Kazakstan. Modernization, security, and stability in the region are the main points on the SCO’s agenda today.

Beijing’s contribution to the SCO is of great economic significance. At a certain point, Beijing succeeded in convincing Moscow and the Central Asian Republics, that the organization’s range of activity should encompass as many areas as possible, including economic, humanitarian, and integration matters, not merely security alone. Accordingly, in 2005 the P.R.C. offered \$900 million for the development of economic projects. Procedures for operation of this “second wheel,” economic cooperation, were set in motion, so that the organization’s activity became truly more comprehensive. Humanitarian activity and the “second road” also took shape, in the form of the SCO Forum, etc. China’s long-term and well-conceived policy of “harmonizing the SCO” met full support from the other five members at the summit. It is quite likely that the SCO project is only one aspect of China’s longer-term strategic design for Central Asia.

Thus, despite its discussions being internal, the SCO has outgrown its “regional suit” and is trying on larger “geopolitical clothes.” The organization’s sphere of interests today encompasses Central and Northeast Asia. In the medium term, this will extend to South Asia and the Middle East. At the same time, the organization has, in effect, institutionalized the famous Russia-India-China “triangle,” in a certain way, considering that India is an observer. It is planned to hold SCO military exercises in Russia during 2007, with units from all six member countries taking part. The Russian-Chinese exercises, Peace Mission-2005, already took place in the P.R.C., while there were a series of Russian-Indian ground and naval maneuvers during 2004-05.

Prospects and Prognoses for 2006-08

If India and Pakistan join as full members, this could be a major geopolitical factor in the strengthening of the SCO. Russia’s priority partner in that pair is India, while for China, despite the radical improvements in relations between Beijing

and New Delhi, it remains Pakistan. Besides the moratorium on enlarging the number of SCO members, the Kashmir problem and the non-adherence of India and Pakistan to the NPT are obstacles to their joining. The latter violates the other SCO members’ formal commitment to strictly following non-proliferation procedures. Equally difficult is the situation with Iran. Participation in the SCO gives the leadership of the Islamic Republic of Iran the possibility of obtaining an additional political resource in its stand-off with the U.S.A. and its allies. Iran’s energy potential is attractive for the SCO, since it is a major oil and gas producer, providing resources that India and China would like to use. As is well known, a major Iranian-Indian gas project, involving the supply of gas to India, is already under implementation. Pakistan, which wants to hook in to Iranian gas, has an objective interest in this project. Russia is interested, because of the deepening Russian-Iranian cooperation in the area of peaceful nuclear power (construction of the Bushehr nuclear power plant) and the development of north-south transport “corridors,” which are beneficial for Moscow.

At the same time, the SCO’s rapprochement with Iran brings with it the danger of a worsening of the organization’s relations with the U.S.A. This concerns India, Russia, and Pakistan, first and foremost. Understandably the SCO, as an organization that represents an alternative to American projects, has some interest in political rapprochement with Iran, but within certain limits. There are concerns in Moscow, Beijing, and New Delhi, that Iran might at some point break away from any influence, not only of the SCO, but of the entire world community.

The SCO and 50-Year Development Prospects

by R.G. Tomberg

Professor Tomberg is a scholar at the Center for External Economic Research, Institute of Economics, Russian Academy of Sciences (RAS), Moscow. He sent this letter to the Berlin conference on Sept. 4.

Dr. [Dmitri] Sorokin [of the Institute of Economics, RAS] was kind enough to inform the Center for External Economic Research, which since 2005 has been an integral part of the RAS Institute of Economic Studies, about the forthcoming international web conference in Berlin on the strategic perspectives of mankind for the next 50 years, with a special emphasis on the Eurasian role in world development. . . .

As you mentioned the eventual role of the Shanghai Organization for Cooperation as “one of the key parts of the

emerging world system of economic cooperation between sovereign nation states,” I venture to make some brief comments on this issue.

Evidently, this organization was established by very dynamic nations of Central and East Asia, including Russia, and its role in regional and world policy is steadily increasing. But up til 2005-06, the economic cooperation between member states was not more than a declaration and a desire for the future. Furthermore, the experience of establishing feasible economic cooperation and corresponding structures between CIS [Community of Independent States] members is still limited, and very decisive actions are needed to bring to life the economic agenda proclaimed at the last summit of the organization. This is a real challenge for SOC.

Another challenge is the problem of poverty—global, in the developing world—and in SOC countries, even in Russia and China. The resolution of this problem is one of the critical issues for solving today’s strategic crisis and “economic recovery of the Earth,” as Mr. L. LaRouche mentioned.

May I wish all success to the conference in Berlin.

R.G. Tomberg

Primakov Issues Book On Mideast Prospects

Vladimir B. Isakov, the vice president of the Chamber of Commerce and Industry of the Russian Federation, who works directly under the president of the Chamber of Commerce, Yevgeni M. Primakov, former Prime Minister of Russia, sent this contribution to the Berlin conference. Dr. Isakov regretted that he would be travelling during the conference, but conveyed his best wishes for its success, and submitted the text of this statement, which was delivered by Primakov on Sept. 4 in Moscow at a press conference to launch his book, Confidential: The Middle East in the Spotlight, and Behind the Scenes. The translation was done by EIR, and subheads have been added.

For Lyndon LaRouche’s comment on Primakov’s thesis, as the latter was summarized at the Berlin meeting, see last week’s EIR.

This book is about one of the main aspects of what I have experienced in my life. I have been dealing with the Middle East for over half a century, as a journalist, a scholar, and a politician. As Yesenin wrote, “What we cannot see, face to face/ Big things are seen from a distance.” The book reflects this, to a certain degree. This is not only because certain documents, which were previously not generally accessible, have been published here for the first time. For the first time in many years, I opened my diaries, some of which have yel-



DoD/R.D. Ward

Yevgeni Primakov. In his press conference statement, relayed to the Berlin meeting by his associate V.B. Isakov, Primakov called for an international conference to work out a peace settlement plan for Israel and the Palestinians.

lowed pages, and read them over again. The book includes a reconsideration of certain events, certain processes.

Naturally, the book will be criticized. In any event, for one thing, there are many established notions, with which it does not coincide. At the same time, however, it does not share nihilistic evaluations of everything from Soviet times. I have tried to write an objective book.

Now it goes before the court of the readers, as they say. . . .

Two Nationalisms

I would like to take the opportunity of our meeting today, to share with you some thoughts about problems, related to a settlement of the Middle East conflict—a chronic, bloody, and dangerous conflict, which touches the interests of practically the entire world community, in one way or another. This conflict is not, and I would like to emphasize this, either religious or social in character; whether or not we recognize the fact, it is a clash between two nationalisms. So, is it possible to reach a settlement of this conflict?

Henry Kissinger, who is one of the most experienced and intelligent politicians of the 20th Century, concluded that regional conflicts are more susceptible of being settled, when they are in a “hot phase.” In principle, I agree with this way of posing the question, although, of course, that does not mean that conflicts ought to be “heated up,” in order to settle them. I am grateful to Kissinger for writing the preface to my book, *The World After September 11 and the Invasion of Iraq*, which was published in English in the U.S.A., but my opinion of him as an analyst is by no means predetermined by the fact that he wrote it, nor by some assumption that I would share all of his approaches to the Middle East and related matters.

But, let us turn to the facts.

The 1967 war. After it ended, efforts to achieve a settlement failed. Israel did not want to vacate the occupied territories for anything. And the Arab leaders, motivated by their



Vladimir Isakov (center), vice president of Russia's Chamber of Commerce and Industry, conveyed his greetings to the Berlin conference.

UNESCO

emotions, gave thumbs down to the Latin American UN General Assembly resolution, which would have linked Israeli force withdrawals to the positions of June 4, 1967, with an end to the state of war with Israel. This position of refusing to negotiate with Israel was also affirmed at the Arab summit in Khartoum. And yet some chances of finding a pathway to a settlement did exist. The Arab position evolved somewhat, in which the influence of the U.S.S.R. played a role. That is borne out by the fact that, after the Khartoum meeting, the main Arab countries agreed to UN Security Council Resolution 242. But the U.S.A. made no steps towards a settlement. The Soviet Union also failed to take advantage of the situation. During [Soviet Prime Minister] Alexei Nikolayevich Kosygin's meeting with President Johnson in the U.S.A., the Americans threw out the idea that they might be interested in Soviet help in getting out of the "Vietnam dead end." Kosygin could have tied this in to a coordination of the positions of the two superpowers on a Middle East settlement. But the Cold War was under way; and, in addition, the U.S.S.R.'s head of government lacked the authority to act in this way. Overall, his meeting with Johnson was viewed as an interim event, of little significance. The established practice in that period was that all real summits had to involve Brezhnev. I write about this in my book.

The 1973 war. The Geneva Conference was convened, after it ended. It would seem that the situation was now more favorable for a settlement. The first phase of that war had stunned Israel. Not even their eventual military victory could erase the true state of affairs, which had been revealed to the Israelis: that the Arab countries were beginning to draw even

with Israel, militarily. But the pathway to peace was blocked, because the U.S.A. departed from the line that led towards a comprehensive settlement, emphasizing rather the preparations for a separate agreement between Israel and Egypt.

What is happening in the Middle East today is also a real war, which Israel is waging on three fronts: in Lebanon, Gaza, and the West Bank. It can be said that the conflict has "heated up" again, bringing out certain realities, which ought to be used in order to achieve a settlement.

The Realities Today

First reality. Events have shown that Israel cannot achieve its objectives militarily. The agreement to exchange the seized Israeli soldiers, for Palestinian and Lebanese prisoners in Israeli prisons, is quite telling in this regard. Israel's efforts to defend its citizens should be given their due, but they had wanted to obtain the soldiers' release by using force on a large scale, and it didn't work.

Second reality. Events have shown that it is impossible for Israel to establish its borders unilaterally, without negotiations. That was Sharon's goal, and it has been Olmert's. The annexation of the occupied territories is also precluded, as an alternative to that unilateral approach to the establishment of borders, because then Israel would cease to be a Jewish state, since the Arab part of the population would, with time, become larger than the rest of the population.

Third reality. Events have shown that it is impossible for Israel to ensure its security, without an overall settlement of the conflict. That means the necessity of moving forward not only on the Palestinian track, but also, and most importantly,

on the Syrian. After the failed attempt to reopen the wounds in the internal Lebanese situation, it has become even clearer than before, that there must be negotiations with Syria on returning the Golan Heights. It is good that even a member of the Israeli government is talking aloud about this. That has never happened before.

Fourth reality. Unless the Middle East conflict is settled, it will become more dangerous, taking into account the Iran factor, not only for its immediate participants, but also for the main players in the international arena, including the U.S.A.

Fifth reality. It can be presumed that the United States, and not for the above-cited reason alone, will be more interested in a Middle East settlement; and such a settlement is practically impossible, without the United States. Despite the upcoming elections, which do, of course, reduce Washington's room for action to influence Israel towards compromise, there is such an interest, based on the fact that the U.S.A. has gotten bogged down in Iraq, and is rapidly losing its authority in the Arab world. A settlement of the Middle East conflict could compensate for many U.S. losses in the Middle East.

Sixth reality. In the multipolar world that is taking shape, Europe, China, India, and some others, which are clearly inclined to favor a Middle East settlement, are acquiring ever greater possibilities for influencing the world situation.

Lastly, I do not see any insurmountable obstacles to finding solutions for the problems that would represent the basis of a settlement.

Borders. They could be defined, including through a certain adjustment of the cease-fire lines, and even some small territorial exchanges.

Refugees. The right of return does not mean that they all will want to return. A majority may prefer financial compensation, which will enable them, finally, to stop living in the Palestinian camps, and to settle either in the Palestinian state, or in some other Arab country. Incidentally, my book mentions that Gamal Abdel Nasser, already, wrote to Israeli Prime Minister Sharett about such compensation, in one of his secret letters. The topic of separating the right of return, in principle, from the mechanism—including compensation—was discussed fairly recently during informal talks between former Israeli minister [Yossi] Beilin and member of the PLO leadership Yasser Abd Rabbo. The conversation partners agreed.

Jerusalem. We should remember, at the very least, that none other than American President Clinton, in his settlement plan, proposed the division of Jerusalem into two parts: an Israeli and a Palestinian.

Of course, these are all difficult problems. Nonetheless, I still advocate, first, that the Quartet [Russia, United States, European Union, United Nations], bringing in other participants, work out a compromise settlement plan; and, secondly,

demand that it be accepted by the parties to the conflict. After all, we have the precedents that Israel came into existence, and Palestine was partitioned, not as the result of Jewish-Arab negotiations. The convocation of an international conference, with the active participation of Russia, the U.S.A., Europe, and the UN, could be a way to implement the ideas I have indicated. . . .

Support for LaRouche's Long-Term Perspective

by Prof. O.L. Kuznetsov and Prof. B.Ye. Bolshakov

Professor Kuznetsov is the Rector and Professor Bolshakov is a professor, at the Dubna University of Nature, Society, and Man, in Dubna, Russia. They were long-time collaborators of the late Dr. Pobisk G. Kuznetsov (see a commemoration in EIR, Dec. 28, 2001). Dr. O.L. Kuznetsov is also president of the Russian Academy of Natural Sciences. They sent this paper to the Berlin conference (translated from Russian by EIR). Mr. LaRouche's comments on this and related contributions were published in last week's issue.

Lyndon LaRouche is well known in Russia as a major scientist, an outstanding economist, and a distinguished American political figure, one of the most important and prominent partisans of the idea of cooperation between the U.S.A. and other countries on the economic development of Eurasia, in the spirit of Franklin Roosevelt.



Russian Academy of Natural Sciences

Prof. O.L. Kuznetsov hailed LaRouche's ideas as the basis for analyzing man's strategic perspectives for the next 50 years.

The fundamental ideas of L. LaRouche's physical economy are consonant with the ideas of such scientific luminaries as G. Leibniz, V.I. Vernadsky, and P.G. Kuznetsov. They are the basis for a profound analysis of the global monetary and financial system, and the strategic perspectives for mankind's next 50 years.

In the past half-century, a yawning gap has been steadily growing between the real value of the total world product, and its nominal (speculative) value, which is not backed up by any real power. During that period of time, the gap has grown from U.S.\$2 trillion, to \$450 trillion, threatening to cause a global catastrophe. One of the consequences is hyperinflation, and the inappropriate policy of spreading asymmetrical warfare throughout the world.

All of this goes to confirm L. LaRouche's conclusions concerning the crisis of the global monetary and financial system, and the necessity of adopting positive measures to avert catastrophe and create a new system.

In our view, a new monetary and financial system should include key elements of the original Bretton Woods system, as well as kilowatt-hours as a universal measure of value.

We share L. LaRouche's position, that work to develop a new system must rely on the principle of "the benefit of the other," formulated in the spirit of the 1648 Treaty of Westphalia.

Respectfully,
Prof. O.L. Kuznetsov
Prof. B.Ye. Bolshakov

Nuclear Energy and Sustained Development

by Dr. Stanislav Subbotin

Dr. Subbotin is from the Kurchatov Institute in Moscow, an associate of Academician Ye.P. Velikhov. The full title of his paper, submitted to the Berlin conference, is "Nuclear Energy As the Basis for Transition to a Sustainable Development Trajectory" (excerpted here and translated from Russian by EIR). His remarks were summarized at the conference, and Lyndon LaRouche's comments appeared in last week's issue.

In the 21st Century, mankind will be faced with practically all of the consequences of that large-scale experiment in increasing "one's own" wealth, by utilizing "cheap" sources of energy, namely extracted organic fuels.

It should be realized clearly, that we currently have a civilization, whose viability is based on non-renewable processes, and cannot be separated from the rising production

and consumption of electricity and various types of fuel for various possible means of transport. The raw materials resources from which these are derived (oil, gas, and coal), no matter how great they might now seem, can provide for the existence of this civilization for no more than 20-50 years, without serious political and economic disturbances; not to mention unpredictable changes in the functioning of the biosphere as a whole, local ecological disasters, and climate change.

No political and economic reforms will solve the oncoming problems, unless they have at their disposal a functioning power industry, which is a kind of core of any economy. It is necessary to develop and implement new principles and methods of obtaining energy, without large-scale intervention into the cycles of the biosphere. There must be a change of values, in order to stop taking resources from the Earth and from future generations, virtually without payment, for the sake of enriching individual countries and people.

Based on the unrestrained consumption of "cheap" energy resources, the modern economy is ignoring the laws of development of the biosphere, leading to the degradation of humanity as a biological species.

It is evident that the efforts of science to find new fuel resources ought to be accompanied by efforts to limit the use of them, at least by forecasting the consequences of these processes. It is necessary to expand the resource base, not so much for the sake of expanding the production of all sorts of "goods," as to increase the depth of reliable forecasting and planning for the further development of mankind. "Use, but do not abuse: Such is the law of wisdom. Neither abstinence nor excess bring happiness."—Voltaire.

The various energy technologies that use renewable energy resources, organic, and nuclear fuel, and thermonuclear fusion, should be seen not as competing, but as complementary in the creation of a harmonious structure of power production, capable of satisfying all of society's needs for different types and qualities of energy. Only if the composition of power production is harmonious, multifunctional, and multi-component, will it be possible to spare society the effects of inefficient energy use, premature exhaustion of energy resources, and the need to use expensive energy resources, and thus to prevent the unjustified increase of the cost of producing energy and the attendant decline in social prosperity.

The definition of a society's sustainability is based upon its attitude toward resources. A society can be sustainable, if the rates of consumption of renewable resources do not exceed the rates at which they are replaced.

Of course, the utilization of renewable energy sources will develop during the 21st Century: wind, rivers, and tides, as well as non-renewable, non-traditional energy sources such as geothermal energy, etc. But it should be kept in mind, that there is nothing superfluous or unharmonious in the biosphere. These sources are renewable, only if the functioning



insp.pnl.gov

“The only source of energy, capable of supplying humanity with high-quality energy on a large scale, for a long period of time, reliably and safely, is nuclear fission energy from heavy elements: uranium and thorium,” writes Dr. Subbotin. Here, the Kalinin nuclear plant in Russia.

of the biosphere is not disrupted, i.e., only if there are merely minor perturbations; and it remains to be scientifically determined, what constitutes a minor, tolerable disturbance.

There are great enough renewable energy resources, to allow the solution of some tasks. But for renewable resources really to become available to mankind, in the forms in which humans have grown accustomed to using energy—where it is wanted, when it is wanted, in adequate quantities, and of the needed quality—requires the investment of enormous intellectual resources (which potentially are capable of sustained growth) and material resources (chiefly non-renewable).

The only source of energy, capable of supplying humanity with high-quality energy on a large scale, for a long period of time, reliably and safely, is nuclear fission energy from heavy elements: uranium and thorium.

A developed nuclear power industry will make it possible to free up organic resources to meet mankind’s needs for chemical energy, clothing, food, construction materials, etc. The reserves of nuclear fuels, which so far are not used for any other purpose than generating power, are quite sufficient for solving the problems of harmonizing human society and the biosphere, on its pathway to becoming the noösphere, without trouble or political tension. Furthermore, nuclear fuel does not burn; rather, it turns into the products of fission, among which are extremely useful nuclides for technogenic civilization, from alkaline metals, to the noble metals and gases.

The use of nuclear power opens up a new evolutionary process, which implies a new technological revolution.

It should be noted that nuclear power is currently beginning more and more to be seen as a quasi-renewable energy technology. This is because a properly organized nuclear power industry, with a complete fuel cycle for the actinides (thorium, uranium, plutonium, etc.) can maintain, or even increase, to the extent needed, the neutron potential of the system. The fuel resources for nuclear power (uranium and thorium), in that case, are practically unlimited; and it is possible for the nuclear power sector to include high-temperature nuclear reactors, which are capable of producing hydrogen from water at fairly high rates of efficiency.

In a new power generation system, acceptable for long-term and large-scale use, nuclear power will be not only an efficient power source, but will also perform the control function of keeping CO₂ emissions into the atmosphere, as well as radiation, at proper levels. And some of the funds, economized in the organic-fuel power sector through measures to prolong its existence and make it more efficient, should be used for creation of a nuclear power sector, adequate to the requirements of sustainable development.

The Structure of the Nuclear Power Sector, Necessary for Its Sustained Development

...Work on nuclear and thermonuclear power not only provides an example of how to organize scientific research, experimental design, and international cooperation on the large-scale use of hydrogen and renewable resources, but it also helps in achieving a better understanding of processes taking place in nature. It becomes clear that just as much of an intellectual and material investment needs to be made

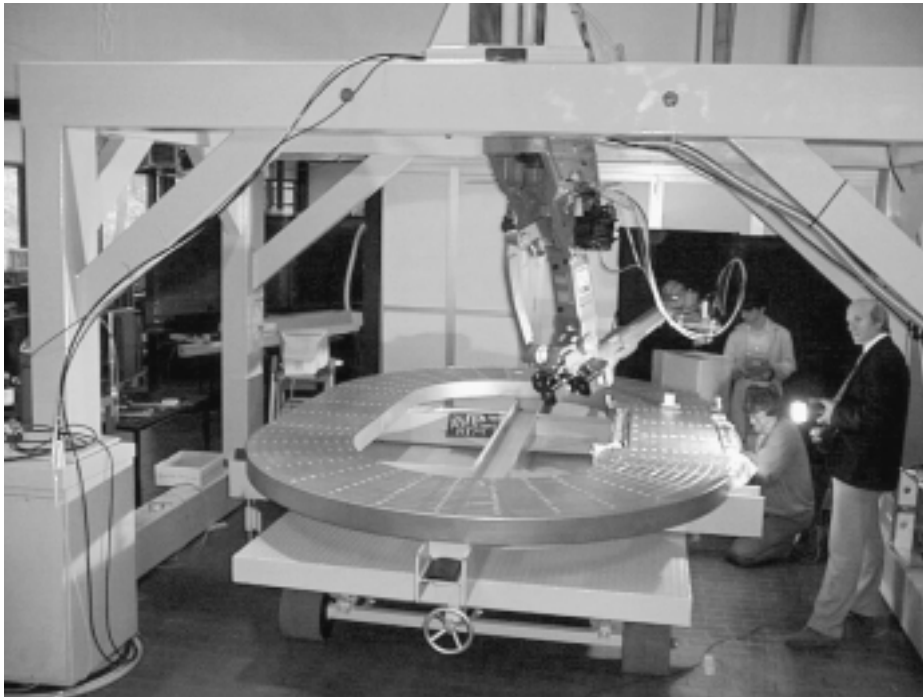

ITER.org

Construction on a research module for the International Thermonuclear Experimental Reactor. "Work on nuclear and thermonuclear power not only provides an example of how to organize scientific research, experimental design, and international cooperation on the large-scale use of hydrogen and renewable resources, but it also helps in achieving a better understanding of processes taking place in nature."

in the large-scale utilization of natural processes (so-called renewable resources), as is done in the area of nuclear power and controlled thermonuclear fusion. Therefore, in a global, liberalized financial market, conditions cannot be created for conducting the needed profound and extensive R&D work, without the relevant studies being done in the nuclear power area, and without political steps at the government and international level; nor will there emerge serious interest in nuclear energy as the basis for sustainable development, in hydrogen as an ecologically clear fuel, capable of substantially helping mankind to move onto a path of sustainable development.

The world economy is now in a transitional period, and the future of civilization, whose main wealth is people and natural resources, depends on shifting into a new technological and economic phase. . . .

Although it has been termed global, and pretends to be a mechanism for sustainable development, the economy has really not become global, never mind guaranteeing the possibility of following the principles of sustainable development. In the form in which it currently functions in the advanced countries, the economy cannot become global and sustainable. In a global and sustainable economy, the various regions where the participants in this economic process live should be equally important, and the interests of all participants should be equally satisfied, at least potentially. So far, only one of the parties to the economic mechanism is becoming global. All of mankind is of necessity being drawn farther and farther into the process of providing steady development for

the "developed" countries. This process cannot be a prolonged one, either for the developed, or, most assuredly, for the "developing" countries. . . .

It is not entirely clear, how, in what direction, and on what scale the gas, oil, and coal industries will be transformed. There are many views, ideas, proposals, hypotheses, theories, strategies, and conceptions about this. But, however we might improve them, they are insufficient, particularly due to limited resources and ecological impact. These technologies have to be supplemented by "renewable" energy sources and nuclear power sources. . . .

It should be noted that small-scale nuclear power has its own very important task in the world: It can be the basis for activating growth points, in a global economy with sustainable development, in places where economically efficient activity would otherwise be impossible. It serves as a kind of "emergency" source of energy, being an energy source for making economic breakthroughs, achieving growth along a front of modern economic acceptability and efficiency (i.e., to expand the areas in which people can live normally and pursue normal economic interests).

The Components of a Mechanism for Sustainable Development of the Power Industry

The development of the power industry in the 21st Century depends on the economy, and on politics, science, and education. These parts may be seen as separate today, but in the future they will be closely interwoven. Science and

education must plant now, what will be reaped in 20-30 years through the economic mechanism. And in order to satisfy those requirements that can be anticipated now, political decisions must be made already today, both at the government level and internationally—to organize the kind of science and education that can provide for both the expected, and the not-yet-anticipated needs of mankind in the 21st Century, with respect to the quantity, reliability, and safety of power generation and energy consumption, taking into account the need to mitigate and eliminate both the expected and the unexpected effects of our large-scale intervention, which we still only poorly understand, into the living organism of the biosphere, with our mechanical devices and “prostheses.” In all of this, the economy ought not to be an end in itself, but a mechanism, which can adapt to new opportunities, new resources, and new requirements, and address not only the immediate tasks of existence and survival, but also the long-term objectives of sustainable development.

The Inevitable Incorporation of Russian and CIS Resources Into the World Economy

Russia possesses huge reserves of extractable hydrocarbons and other mineral resources.

Currently Russia is viewed as a source of fossil fuels and an energy bridge between Europe and Asia. It is clear that Russia should and will export gas, oil, and in the future also coal, as well as electricity, but it is important to determine what the scale of such exports should be, and what Russia should receive in exchange.

It is forecast that Russia will export hundreds of billions of cubic meters of natural gas to Europe and Asia during the coming century; pipelines will be built, as well as transport infrastructure for LNG deliveries; high-tension power lines will be laid to Europe and to Asia. But the world as a whole will lose, as will Russia, if Russia is used only as a supplier of organic and mineral resources.

Russia possesses one extraordinarily valuable renewable resource, without which it would be impossible to survive the great array of crisis situations, expected in the 21st Century. That unique resource is Russia’s intellectual, and scientific and technological potential, which came into existence as the result of the historical, geographical, and linguistic conditions of life in this multinational state, which has synthesized in its culture the achievements of science, technology, thought, and spirit, of both the West and the East. Without such a synthesis of cultures, without the intellectual conceptualization of the past, without a shift in the development paradigm, including changes in the perception of spiritual and material values, all the technical or economic measures, and all the organic and mineral resources in the world will not suffice to create a sustainable society, or even to survive the 21st Century without big upheavals, since practically all crises are fundamentally intellectual in nature.

China

Can We Establish a New Bretton Woods?

by Prof. Dai Lunzhang

The following comments and questions were posed by Prof. Dai Lunzhang, former chief economist of the Central Bank of China, first vice president of the China International Economic Relations Society, and one of China’s leading experts in banking and finance, presently manager of an investment company in Shanghai. He was joined in his remarks by Dr. Zhang Yun and Mr. Dai Jun, MA in International Relations. Their comments and questions were summarized at the Sept. 6 webcast in Berlin by moderator Jonathan Tennenbaum. In responding, Lyndon LaRouche noted that these, and other similar remarks, all “converge on the same point. . . . Money has no intrinsic value,” and advised that economic questions had to be viewed “in terms of generations.”

Comments

1. The world we live in today is undergoing complex and profound changes. Steady economic growth, rapid progress in science and technology, the accelerated relocation of industries and the movement of production factors worldwide, have created a dynamic international market. However, such processes, widening the gap between rich and poor, underscore the increasing imbalance in global development, and therefore, incur two dangers; as Mr. LaRouche has stated, *they are: 1) the danger of uncontrolled conflicts and wars; 2) the danger of a general breakdown of the world financial and monetary system.* Those two dangers are the biggest threats to human society. So, I believe his point of view is accurate and significant.

2. Thanks to its exploration and practice, the international community has arrived at a deeper understanding that it must secure peace and promote development through cooperation, which is the tendency of world growth. As for China, Foreign Minister Mr. Li Zhaoxing stated last year: *“China’s period of strategic opportunities that we talk about is nothing but an international environment and evolutionary process where world peace is maintained and common development promoted. It is only under this strategic premise that we can achieve the grand goal of building a moderately prosperous society in an all-around way.”*

Peace and development conform to the human being’s wish. Wars and armed conflicts are contradictory to the main-

stream, disturbing and undermining these basic values.

3. Therefore, human beings should utilize their wisdom to restrain wars and economic crises to maintain the tendency of peace and development. From my view, disputes among countries should be resolved through diplomatic methods such as contact and negotiation. At the same time, we should distinguish the resolution of bilateral disputes from the fight against terrorism. As we can see, terrorism is the most destructive factor in the 21st Century, and it should be eliminated to the core.

However, the disputes between countries could not be resolved simply by means of war. For example, Palestine and Israel have not reached a peace agreement through four rounds of the Middle East war. So I believe the only way to settle the conflicts is diplomatic means, which requires the disputing parties to take calm and reasonable positions.

4. Nowadays, the ongoing economic globalization has increased the level of economic interdependence on the one hand, and aggravated by the unevenness of development on the other hand. So, it's time to reform the timeworn international economic systems, and members of the international society should fully cooperate to correct the unreasonable parts of the current system. As Mr. LaRouche has mentioned many times, a new round of the Bretton Woods Meeting should be held, and a new international economic system should be established.

As a saying goes, "Reducing pressure could avoid a crash," so the best way to prevent a particular currency from collapse is to avoid its being an internationally core currency.

Questions

1. Mr. LaRouche has mentioned many times on various occasions, that a new round of the Bretton Woods Meeting should be held to establish a fresh international currency system. In my opinion, going back to a fixed-rate system is surely not a feasible solution. We may enhance the function of IMF special drawing rights, which could finally be a dominant currency at the international monetary market.

So my question is: What is your concrete thought of this "New Bretton Woods System"? And how could a new international economic system be established?

2. It is well known that the political bases for the Bretton Woods system are to be found in the confluence of several key conditions: the shared experiences of the Great Depression, the concentration of power in a small number of states, and the presence of a dominant power willing and able to assume a leadership role. Unfortunately, these conditions are hardly true in today's world.

Do you think a new international economic system could be founded on different political bases than those of the Bretton Woods system?

3. Eurasian cooperation includes Western and Central Europe, Russia, China, India, and other nations. It is a good

proposal, but I think this new cooperation should not exclude the U.S.A., the only superpower today and in the future, and the U.S.A should play a critical role in the reform of international politics, economics, and currency system.

What do you think of this view? Would you please give some comments on it? If your comments are positive, then how could the U.S.A. play a constructive role in this regard?

4. Mr. LaRouche mentioned the necessity for the United States to change its present destructive policies, and to support such a development perspective. We know the upcoming mid-term election in the U.S.A. in November is an important one.

So, my question is: How much will it [the election] affect the prospect for a political change in the U.S.A.? And furthermore, what impact will the 2008 Presidential election have on the political landscape of the U.S.A.?

5. Mr. LaRouche has talked about the role of the Shanghai Cooperation Organization (SCO) in Eurasian cooperation. The SCO just celebrated its fifth anniversary in Shanghai this year. I believe its role and influence will continue to grow.

How to handle the relationship between SCO and the U.S.A. remains very delicate and essential to further cooperation. So, what is your suggestion? Would you comment on this topic?

If You Thought Adam Smith Was The Founding Father of America's Economic Strength—

Think Again.

READ

*Friedrich List: Outlines of
American Political Economy*

"I confine my exertions solely to the refutation of the theory of Adam Smith and Co. the fundamental errors of which have not yet been understood so clearly as they ought to be. It is this theory, sir, which furnishes to the opponents of the American System the intellectual means of their opposition."

—Friedrich List

\$19.20

ORDER FROM

EIR News Service, Inc.

P.O. Box 17390 Washington, D.C. 20041-0390

Order by phone, toll-free: **888-EIR-3258**

OR order online at www.larouchepub.com

Shipping and handling: Add \$4 for the first book and \$1.00 for each additional book. Virginia residents add 4.5% sales tax. We accept MasterCard and Visa.



LaRouche Demands Immediate Impeachment of Bush, Cheney

Lyndon LaRouche has called on all patriotic Americans to join him in pressing for the immediate impeachment of President George W. Bush and Vice President Dick Cheney. LaRouche issued the call Sept. 11, in the immediate aftermath of three developments:

1. The release on Sept. 7 of two additional chapters from the Senate Select Committee on Intelligence report on the pre-Iraq war intelligence failures, which Senators Jay Rockefeller (D-W.V.) and Carl Levin (D-Mich.) correctly identified as a stinging indictment of the President and Vice President for lying to the Congress and the American people into a needless and disastrous Iraq war;

2. The airing on ABC-TV of the fraudulent mini-series, "The Path to 9/11," on the Sept. 11, 2001 attacks, which was part of a White House-directed propaganda assault against the American and European populations, to soften them up for new wars in Southwest Asia; and,

3. Vice President Dick Cheney's shameless lies, during an hour-long television interview Sept. 10, 2006, with Tim Russert on "Meet The Press."

LaRouche declared, "The administration has lied and lied and lied the United States into a senseless and disastrous war in Iraq. We see a pattern of habitual lying on the part of the President and Vice President. This constitutes more than sufficient grounds for impeachment. I consider," LaRouche continued, "that the impeachment of President Bush and Vice President Cheney is imperative at this time. They have violated their oath of office, and have brought nearly irreparable harm to the United States. The new evidence presented last week by the Senate intelligence panel serves to underscore just how seriously they lied the U.S. into war.

"Furthermore," LaRouche continued, "Vice President Cheney's shameless lying on nationwide television on Sunday, Sept. 10, and his continuing push for a new, even more devastating 'preventive' war against Iran, underscore the urgency of Congress acting now to prepare a long-overdue bill

of impeachment."

LaRouche added that he would hope that former President Bill Clinton would agree with his assessment about the urgency of a Bush-Cheney impeachment and take his own action. "After what has been done to the former President, particularly with the fraudulent ABC-TV disinformation mini-series, blaming the Clinton Administration for 9/11, I would think that he would see the ongoing onslaught against the country, from an ever-more desperate Bush-Cheney White House and its right-wing allies, as cause to issue a similar call. I must say that Hillary Clinton's warnings, as First Lady, about a 'vast right-wing conspiracy' against the Clinton Presidency, ring now in my ear, as I view the recent unfolding events."

Among the incidents that prompted LaRouche to issue his impeachment call was the release of the declassified versions of the two additional chapters from the Senate Select Intelligence Committee investigation into the pre-Iraq war intelligence process. These were accompanied by statements from Sen. Jay Rockefeller, co-chairman of the committee, and Sen. Carl Levin. The chapter refuting Administration claims on both Saddam's links to terrorism, and on Iraqi weapons of mass destruction, was adopted nearly unanimously, 14-1, by the committee. As to the chapter on the role of the Pentagon-linked Iraqi National Congress in shaping policy, Senators Olympia Snowe (R-Me.) and Chuck Hagel (R-Neb.) voted to issue the draft prepared by the Democratic Minority staff of the committee; Snowe said this was because it was closer to the truth.

The newly-issued chapters showed that top Administration officials, including the President, Vice President, then-National Security Advisor Condoleezza Rice, and Defense Secretary Donald Rumsfeld, repeatedly misrepresented intelligence community findings, to support the Iraq invasion with lies that Iraq was tied to al-Qaeda and the 9/11 attacks, and had advanced WMD programs.

Committee Finds No Saddam-al-Qaeda Link

Following are excerpts from the conclusions of the Senate Select Committee on Intelligence report dealing with allegations of Iraqi links to al-Qaeda. This section of the SSCI report was approved by a 14:1 vote in the Committee.

1. "Saddam Hussein was distrustful of al-Qa'ida, and viewed Islamic extremists as a threat to his regime, refusing all requests from al-Qa'ida to provide material or operational support."

2. "Postwar findings have identified only one meeting between representatives of al-Qa'ida and Saddam Hussein's regime. . . . Postwar findings have identified two occasions . . . in which Saddam Hussein rebuffed meeting requests from an al-Qa'ida operative. The Intelligence Community has not found evidence of any other meetings between al-Qa'ida and Iraq." The one meeting identified, was a 1995 meeting between an Iraqi Intelligence (IIS) officer and bin Laden in Sudan; the Iraqi officer was instructed to "only listen" and not to negotiate or promise anything to bin Laden, and Saddam Hussein immediately rejected all of bin Laden's requests.

3. Regarding allegations that Saddam Hussein provided CBW (chemical-biological weapons) training to al-Qaeda: "No postwar information has been found that indicated CBW training occurred and the detainee who provided key prewar reporting about this training recanted his claims after the war." The cited detainee was Ibn al-Shaykh al-Libi, who says he made up false claims under abusive treatment and threats of torture.

4. "Postwar findings support the April 2002 DIA assessment that there was no credible reporting on al-Qa'ida training at Salman Pak or anywhere else in Iraq. . . . [T]he DIA told the Committee that it has no 'credible reports that non-Iraqis were trained to conduct or support transnational terrorist operations at Salman Pak after 1991.' "

5. While post-war information supports the Intelligence Community's assessment that al-Zarqawi, using an alias, was in Baghdad in 2002, "Postwar information indicates that Saddam Hussein attempted, unsuccessfully, to locate and capture al-Zarqawi and that the regime did not have a relationship with, harbor, or turn a blind eye toward Zarqawi." Post-war information indicates that Saddam Hussein "considered al-Zarqawi an outlaw."

6. "Ansar al-Islam operated in Kurdish-controlled northeastern Iraq, an area that Baghdad had not controlled since 1991. . . . Postwar information reveals that Baghdad viewed Ansar al-Islam as a threat to the regime and that the IIS at-

tempted to collect intelligence on the group."

7. "Postwar information supports prewar Intelligence Community assessments that there was no credible information that Iraq was complicit in the September 11 attacks or any other al-Qa'ida strike." No meeting in Prague between Iraqi intelligence officer Ahmed al-Ani and Muhammed Atta occurred. "Postwar debriefings of al-Ani indicate he had never seen nor heard of Atta until after September 11, 2001, when Atta's face appeared in the news."

8. "No postwar information indicates that Iraq intended to use al-Qa'ida or any other terrorist group to strike the United States homeland before or during Operation Iraqi Freedom" (the U.S. invasion).

9. "While document exploitation continues, additional reviews of documents recovered in Iraq are unlikely to provide additional information that would contradict the Committee's finding or conclusions."

Documentation

'A Devastating Indictment'

Sen. Carl Levin (D-Mich.) told the U.S. Senate that the Senate Select Committee on Intelligence's partial "Phase II" report "is a devastating indictment of the Bush Administration's unrelenting, and deceptive attempts to convince the American people that Saddam Hussein was linked with al-Qaeda. . . ." Twice, during his 28-minute floor statement of Sept. 8, Levin used the term "indictment" when referring to the Bush Administration's misuse of intelligence. Levin took the floor after an opening statement by SSCI Ranking Member **Jay Rockefeller** (D-W.V.) who detailed how the Republican chairman of the committee, Sen. Pat Roberts (R-Kan.) had shut down the Intelligence Committee, rather than allow an investigation into the White House role in spreading, or organizing fabricated intelligence.

The SSCI report that was released to the public is unclassified, and was substantially *rewritten* to protect the White House. Levin charged that a massive "coverup" is underway, and that the public must see the full report:

"The intelligence assessments contained in the Intelligence Committee's unclassified report are an indictment of the administration's unrelenting and misleading attempts to link Saddam Hussein to 9/11. But portions of the report which the intelligence community leaders have determined to keep from public view provide some of the most damaging evidence of this administration's falsehoods and distortions.

". . . Among what remains classified, and therefore covered up, includes deeply disturbing information. Much of the information redacted from the public report does not jeopard-



rockefeller.senate.gov

Senators Jay Rockefeller (D-W.Va.) and Carl Levin (D-Mich.) denounced the Bush Administration's deceptive claims that Saddam Hussein was linked with al-Qaeda.

dize any intelligence source or method but serves effectively to cover up certain highly offensive activities.”

Levin continued: “While the battle is waged” to declassify the full report for the public, “every Senator should read the classified version of the report.”

The combined Rockefeller/Levin floor statement, releasing the report, has been poorly reported to the American public, with very few quotes. To get a flavor of what occurred on the Senate floor, we are providing some key excerpts.

The White House's 'Deceptive Strategy'

Senator Rockefeller opened the discussion with an announcement of the release of the SSCI's “Phase II” reports, and their purpose:

“Fundamentally, these reports are about accountability. They are about identifying the mistakes that led us to war and making sure those mistakes never happen again, so far as we can do so.

“Let me share some important excerpts from the report which reflect both my own views and the views of all of my Democratic colleagues on the committee.

“The committee's investigation into pre-war intelligence on Iraq has revealed that the Bush Administration's case for war in Iraq was fundamentally misleading. . . .

“Most disturbingly, the administration, in its zeal to promote public opinion in the United States before toppling Saddam Hussein, pursued a deceptive strategy prior to the war of using intelligence reporting that the intelligence community warned was uncorroborated, unreliable, and, in critical instances, fabricated. . . .

“Some of the false information used to support the invasion of Iraq was provided by the Iraqi National Congress, the

INC. . . .

“The committee also found the July 2002 decision by the National Security Council directing that the renewed funding of the INC contract—the Iraqi National Congress, the Chalabi operation—be put under Pentagon management was ill advised given the counterintelligence concerns of the CIA and warnings of financial mismanagement from the State Department. . . .

“The administration's—this is key—the administration's repeated allegations of the past, present, and future relationship between al-Qaeda and Iraq exploited the deep sense of insecurity among Americans in the immediate aftermath of the Sept. 11 attacks, leading a large majority of Americans to believe, contrary to the intelligence assessments at the time, that Iraq had a role in the 9/11 terrorist attacks [emphasis added].

“The administration sought and succeeded in creating the impression that al-Qaeda and Iraq worked in concert and presented a single unified threat to the United States of America. The committee's investigation revealed something completely different.

“The committee found that there was no credible information that Iraq was complicit or had foreknowledge of the Sept. 11 attacks or any other al-Qaeda strike anywhere. The committee also found that Iraq did not provide chemical or biological weapons training or any material or operational support to al-Qaeda prior to the war.

“Furthermore, no evidence was found of any meeting between al-Qaeda and the Iraq regime before the war, other than a single meeting that took place years earlier in 1995, in fact, in the Sudan. That meeting was at a fairly low level, and that meeting did not lead to any operational cooperation at all.

Osama was there, but the Iraqi representative was at a low level. . . .

“During the buildup to war, the intelligence community was placed under pressure to support the administration’s position that there was a link between Iraq and al-Qaeda. This is particularly distressing. This pressure took the form of policymakers repetitively tasking analysts to review, to reconsider, to revise their analytical judgments, or simply asking the same question again and again.

“The committee investigation revealed evidence that this pre-war pressure to conform to administration policy demands may have led to the co-option of the intelligence community.

“The committee’s two-phased investigation has been significantly limited, I must say, by the majority’s refusal to examine issues and documents relative to our inquiry when the issues and documents came close to the White House.

“While a quarter of the committee’s INC report is devoted to a lengthy examination of the CIA’s relationship with the INC in the early and mid-1990s, the committee majority voted down requests by the minority to investigate the flow of intelligence information from the INC that circumvented the intelligence community and went directly to the White House and to Pentagon policy officials in the lead-up to the war.

“Finally, the committee’s inquiry has been hampered by the decision to deal with five Phase II tasks as separate inquiries, which they are not, and complete the report on a piecemeal basis rather than a unified whole. This has been distressing to those of us in the minority. . . . It should not have taken nearly three years to reach the point where we are now. . . .”

‘Flat-Out False’

After the above remarks, Rockefeller turned the floor over to Levin (the next ranking Democrat), who then cited statements from Bush, Vice President Dick Cheney, Secretary of State Condoleezza Rice, Defense Secretary Donald Rumsfeld, former Deputy Defense Secretary Paul Wolfowitz, and former Secretary of State Colin Powell, in which they made public claims about Iraq’s WMD, and ties to al-Qaeda *long after* intelligence community reports had said the information was false. In fact, Levin charged, with great irony, the President is *still insisting* that Iraq and al-Qaeda were linked before 9/11.

After his opening statement that the SCCI report is a “devastating indictment” of the Bush Administration, Levin said: “The President said Wednesday, just this week, that, ‘One of the hardest parts of my job is to connect Iraq to the war on terror.’

“Well, that shouldn’t surprise anybody. The President’s decision to ignore intelligence community assessments prior to the Iraq war and to make repeated public statements that gave the misleading impression that Saddam Hussein’s regime was connected to the terrorists who attacked us on 9/11, cost him any credibility he may have had on this issue.

“President Bush said Saddam and al-Qaeda were ‘al-lies’—his words. And that: ‘You can’t distinguish between al-Qaeda and Saddam when you talk about the war on terror.’

“The bipartisan report released today directly contradicts that linkage which the President has consistently made in his effort to build public support for his Iraq policy. . . .

“Just two weeks ago, the President said in a press conference that Saddam Hussein ‘had relations with Zarqawi.’ Our Intelligence Committee report demonstrates that statement made two weeks ago by the President was false. The committee report discloses, for the first time, the CIA’s October 2005 assessment that Saddam’s regime: ‘Did not have a relationship, harbor, or turn a blind eye towards Zarqawi and his associates.’

“The President’s statement made just two weeks ago is flat-out false.

“The drumbeat of misleading administration statements alleging Saddam’s links to al-Qaeda was unrelenting in the lead-up to the Iraq war, which began in March 2003.

“On Sept. 25, 2002, the President said: “ ‘Al-Qaeda hides. Saddam doesn’t, but the danger is that they work in concert. The danger is that al-Qaeda becomes an extension of Saddam’s madness and his hatred and his capacity to extend weapons of mass destruction around the world.’

“On Oct. 14, 2002, the President said: ‘This is a man—Saddam is a man that we know has had connections with al-Qaeda. This is a man who, in my judgment, would like to use al-Qaeda as a forward army.’

“On Jan. 30, 2003, Vice President Cheney said: ‘Saddam’s regime aids and protects terrorists, including members of al-Qaeda. He could decide secretly to provide weapons of mass destruction to terrorists for use against us. And as the President said on Tuesday, it would just take one vial, one canister, one crate to bring a day of horror to our nation unlike any we have ever known.’

“On Feb. 6, 2003, Deputy Secretary of Defense Wolfowitz said: ‘And, worst of all, his connections with terrorists which go back decades and which started some ten years ago with al-Qaeda are growing every day.’

“What . . . the President and other administration officials did not say was what the intelligence community was saying about this crucial issue because it would have undermined their march to war and it would have refuted their main argument for attacking Iraq: that Iraq was linked to the terrorists who attacked us on 9/11. . . .”

Cheney ‘Didn’t Stop There’

Levin provided the most damning evidence against Cheney:

“The misleading statements by administration officials didn’t stop there. The Intelligence Committee report recounts the story of the alleged meeting between Mohammed Atta and the Iraqi intelligence officer in Prague. In the Fall of 2001, the Czech intelligence service provided the CIA with

reporting based on a single source who stated that Atta met with an Iraqi intelligence officer in Prague in April of 2001.

“On Dec. 9, 2001, Vice President Cheney was asked about the report on ‘Meet the Press.’ The Vice President said: ‘It has been pretty well confirmed that he—the 9/11 hijacker Mohammed Atta—did go to Prague and he did meet with a senior official with the Iraqi intelligence service in Czechoslovakia [the Czech Republic—ed.] last April, several months before the attack.’

“On March 24, 2002, the Vice President told ‘Meet the Press’: ‘We discovered, and it has since been public, the allegation that one of the lead hijackers, Mohammed Atta, had, in fact, met with Iraqi intelligence in Prague.’

“But the Intelligence Committee report released today cites a June 2002 CIA paper that said: ‘Reporting is contradictory on hijacker Mohammed Atta’s alleged trip to Prague and meeting with an Iraqi intelligence officer and we have not verified his travels.’

“The Intelligence Committee report released today declassifies, for the first time, a July 2002 Defense Intelligence Agency paper that said: ‘Mohammed Atta reportedly was identified by an asset, not an officer, of a Czech service, only after Atta’s picture was widely circulated in the media after the attacks, approximately five months after the alleged meeting occurred.’

“And that: ‘There is no photographic, immigration, or other documentary evidence indicating that Atta was in the Czech Republic during the time frame of the meeting.’

“Two months later, in September 2002, the CIA published its assessment that ‘evidence casts doubt’ on the possibility that the meeting had occurred and that: ‘The CIA and FBI have reviewed the reporting available so far and they are unable to confirm that Atta met al-Ani in Prague.’

“None of those assessments stopped the Vice President from continuing to suggest that the report of the meeting was evidence that Saddam’s regime was linked to the 9/11 attack.

“On Sept. 8, 2002, in a ‘Meet the Press’ interview, the Vice President said that the CIA considered the report of the meeting credible, although again, that same month, the CIA said there was evidence that cast doubt on it having occurred.

“In January 2003, the CIA published an assessment stating that: ‘A CIA and FBI review of intelligence and open-source reporting *leads us to question* the information provided by the Czech service source who claimed that Atta met al-Ani’ [emphasis added].

“The January 2003 paper stated that the CIA was ‘increasingly skeptical’—increasingly skeptical—‘that Atta travelled to Prague in 2001 or met with the IIS officer al-Ani,’ and that, ‘the most reliable reporting to date casts doubt on this possibility.’

“But the Vice President was undeterred by the CIA’s skepticism. On Sept. 14, 2003, eight months after the CIA said

that the most reliable reporting cast doubt on the possibility of a meeting between Atta and the Iraqi intelligence officer, Vice President Cheney was still citing as this having possibly occurred.

“On Jan. 14, 2004, a full year after the CIA expressed serious doubts about the meeting and the fact that not a shred of evidence had been found to support the claim of a meeting, the Vice President told the *Rocky Mountain News* that the Atta meeting was ‘the one that possibly tied the two together to 9/11.’

“Six months later, on June 17, 2004, the Vice President was asked whether Iraq was involved in 9/11. The Vice President said, ‘We don’t know. . . . We had one report, this was the famous report on the Czech intelligence service, and we’ve never been able to confirm it or knock it down. We just don’t know.’

“The Vice President may not have ‘known,’ but the intelligence community sure as heck did not believe, and did not believe for a long time before the Vice President’s statement, that the meeting took place [emphasis added].

“The intelligence assessments contained in the Intelligence Committee’s unclassified report are an indictment of the administration’s unrelenting and misleading attempts to link Saddam Hussein to 9/11. But portions of the report which the intelligence community leaders have determined to keep from public view provide some of the most damaging evidence of this administration’s falsehoods and distortions.”

LaRouche: The Evidence Is There

Senator Levin concludes with the revelation that, in an interview with the SSCI on July 26, 2006, former CIA director George Tenet confessed that “it was wrong” for him to succumb to White House pressure to issue a statement—which he did on Oct. 8, 2002—backing up Bush’s lunatic statement of Oct. 7, 2002 asserting an al-Qaeda-Saddam Hussein link.

Thus, the SSCI report is able to establish that deliberate manipulation—including soliciting (if not ordering) a false statement by Tenet—was used just before the Congressional vote authorizing force in Iraq.

As LaRouche said at his Sept. 6 webcast—just days before the SSCI report came out—the evidence is *already there* to impeach Cheney and Bush. It should be done now.

WEEKLY INTERNET
AUDIO TALK SHOW
The LaRouche Show
EVERY SATURDAY
3:00-4:00 p.m. Eastern Time
<http://www.larouchepub.com/radio>

Investigation

Behind the ABC 9/11 Docudrama

The Axis of YWAM

by Anton Chaitkin

“Youth With A Mission,” the global religious group that cooked up the hoax “The Path to 9/11,” a docudrama aired on ABC Sept. 10-11, is, underneath its public cover, the organization created in the 1920s-1930s by the notorious pro-Nazi Frank Buchman. Above cover, it was known during and after World War II as Moral Rearmament, and also as the National Prayer Breakfast Movement or “The Fellowship” or “The Family.”¹

This imperial agency was crafted by the British and Dutch royal and financier faction that backed fascism and sought a world government in tandem with Hitler. After the death of President Franklin Roosevelt, the Buchman initiative was based at Caux, Switzerland, on Lake Geneva, and was inserted into Washington in aid of its sponsors’ drive for power over U.S. policy.

The Youth With A Mission (YWAM—pronounced “why-wham”) arm of this movement was set up in the 1960s and 1970s by a sort of carnival snake-charmer named Loren Cunningham. His son David Cunningham led a YWAM subunit (The Film Institute) for a rightist “revolution” in Hollywood, and was the director of ABC’s “Path to 9/11.”

Founder Frank Buchman described his agenda in an interview with a New York newspaper, the *World Telegram*, published on Aug. 26, 1936 under the headline, “Hitler Or Any Fascist Leader Controlled By God Could Cure All Ills Of World, Buchman Believes”:

“I thank Heaven for a man like Adolf Hitler, who built a front line of defense against the anti-Christ of Communism,” [Buchman] said today in his book-lined office in the annex of Calvary Church, Fourth Ave. and 21st St.

“My barber in London told me Hitler saved Europe from Communism. That’s how he felt. Of course, I don’t condone everything the Nazis do. Anti-Semitism? Bad, naturally. I suppose Hitler sees a Karl Marx in every Jew.

1. For more on Buchman and the Moral Rearmament movement, See Laurence Hecht, “H.G. Wells and Bertrand Russell: The ‘No-Soul’ Gang Behind Reverend Moon’s Gnostic Sex Cult,” *EIR*, Dec. 20, 2002. For “The Fellowship,” see also Tony Papert, “Mannikin: The Making of Tom DeLay,” in *Children of Satan II: The Beast-Men* (LaRouche in 2004, January 2004).

“But think what it would mean to the world if Hitler surrendered to the control of God. Or Mussolini. Or any dictator. Through such a man God could control a nation overnight and solve every last, bewildering problem.”

Buchman gave the New York interview having just returned from meetings of his “Oxford Group” in England; and from the 1936 Olympic Games in Berlin, where he had been the guest of SS leader Heinrich Himmler. (Buchman had gone to Nazi rallies at Nuremberg with Himmler, whom Buchman claimed to be training in religion.)

“Dr. Buchman,” wrote the *World Telegram* reporter, “listens quietly to ‘God’s plans’ for a half hour or so every day, usually before breakfast. . . .

“The world needs the dictatorship of the living spirit of God. . . . God is a perpetual broadcasting station. . . . What we need is a supernatural network of live wires across the world to every last man, in every last place, in every last situation. . . .

“Human problems aren’t economic. . . . They could be



The late Frank Buchman, Hitler-lover and founder of the movement which spawned Youth With A Mission.

Hitler or Any Fascist Leader Controlled by God Could Cure All Ills of World, Buchman Believes

By WILLIAM A. H. BIRNIE,
World-Telegram Staff Writer.

To Dr. Frank Nathan Daniel Buchman, vigorous, outspoken, 53-year-old leader of the revivalist Oxford Group, the Fascist dictatorships of Europe suggest infinite possibilities for remaking the world and putting it under "God control."

"I thank heaven for a man like Adolf Hitler, who built a front line of defense against the anti-Christ of Communism," he said today in his book-lined office in the annex to Calvary Church, Fourth Ave. and 21st St.

"My barber in London told me Hitler saved all Europe from Communism. That's how he felt. Of course, I don't condone everything

the Nazis do. Anti-Semitism? Bad, naturally. I suppose Hitler sees a Karl Marx in every Jew.

"But think what it would mean to the world if Hitler surrendered to the control of God. Or Mussolini. Or any dictator. Through such a man God could control a nation overnight and solve every last, bewildering problem."

Dr. Buchman, who is directing an Oxford house party tonight at the Lenox, Mass., estate of Mrs. Harriet Putnam Schermerhorn, returned from Europe aboard the Queen Mary, after attending Oxford meetings in England and the Olympic games in Berlin.

A small, portly man, who doesn't smoke or drink and listens quietly to "God's plans" for a half hour or

so every day, usually before breakfast, Dr. Buchman talked easily about world affairs while eight or nine Oxfordites—good-looking young fellows in tweeds—sat on the floor and listened.

"The world needs the dictatorship of the living spirit of God," he said and smiled, adjusting his rimless glasses and smoothing the graying hair on the back of his head. "I like to put it this way. God is a perpetual broadcasting station and all you need to do is tune in. What we need is a supernatural network of live wires across the world to every last man, in every last place, in every last situation."

"The world won't listen to God, but God has a plan for every person, for every nation, ~~Human~~ humanity

is not enough. That is why the lamps are piled against each other and blood falls.

"Spain has taught us what godless Communism will bring. Who would have dreamed that nugs would be running naked in the streets? Human problems aren't economic. They're moral, and they can't be solved by immoral measures. They could be solved within a God-controlled democracy, or perhaps I should say a theocracy, and they could be solved through a God-controlled Fascist dictatorship."

He looked around the room at the eight or nine young men drinking in his words, and straightened the crimson rose in his button hole.

"Suppose we here were all God-

(Continued on Page Six.)

Buchman "lets it all hang out" in this article in the New York World Telegram of Aug. 26, 1936.

solved within a God-controlled democracy, or perhaps I should say a theocracy, and they could be solved through a God-controlled Fascist dictatorship."

The Delphic Oracle As Cheap Comedy

Loren Cunningham and other Youth With A Mission leaders, like the Buchman followers running The Fellowship/National Prayer Breakfast, and such Buchmanite-trained charlatans as televangelist Pat Robertson, shamelessly say that their schemes come from God. The daily "quiet time" is a Buchman-signature boast. Buchman would supposedly sit with paper and pencil, mind empty, to take God's dictation.

For example, in his 1984 book, *Is That Really You, God?*, Loren Cunningham wrote that in 1967, while "I was in bed in California . . . a thought came into my mind: 'You are to have a . . . School of Evangelism.' I wondered if this were from God. . . . Then another thought suddenly cut through, 'Your school is to be in Switzerland.' Switzerland! 'Is this you, God?' I asked in my mind." A few days later, a family friend met him for breakfast and said, "Loren, I have a message for you. The Lord has been planting the idea in my mind that someone should start a school in Switzerland. Last night He told me *you* are to be the one. . . ." He continued "that the school was to have an international student body and visiting teachers. . . . 'Loren, I'm just a channel to pass this message on to you.' . . . We landed in Geneva in April [1967] . . . We made arrangements for a facility in a town outside Lausanne and returned to the States. . . ."

Thus, allegedly, was born YWAM's "Discipleship Training School" world headquarters in Lausanne, Switzerland.

From the Swiss base, YWAM moved across the border into Bavaria, Germany. YWAM bought a castle at Hurlach,

formerly owned by the Fuggers, a feudal-nobility banking family whose undead 20th-Century members sponsored Frank Buchman's Swiss and German intrigues.² Youth With A Mission stuffed 1,000 young followers into this Hurlach castle operational base, for a recruiting assault on the 1972 Munich Olympics, a rerun of Buchman's 1936 glory days in Berlin.

The New Order Makes Breakfast

The National Prayer Breakfast, immediate predecessor of Youth With A Mission within the Buchman initiative, had its origin in the same Manhattan building, Calvary Church, where Frank Buchman gave his notorious 1936 newspaper interview.

That Episcopal church was the American headquarters for Buchman's "Oxford Group" as it was then known, and the Calvary rector, Rev. Sam Shoemaker, was the national spokesman for Buchman. When Buchman was hit with increasing criticism for his praise of fascism as God's instrument, he changed the name of the movement to Moral Rearmament, and his nervous American representatives rushed to get a Buchmanite para-church agency attached to the government in Washington.

The principal agents in this venture³ were:

Longtime Buchman spokesman **Rev. Sam Shoemaker;**

2. See, in the Frank Buchman papers at the Library of Congress, late 1950s letters from Buchman to the fascist U.S. general Edwin A. Walker.

3. See the Buchman/Moral Rearmament papers, Library of Congress; the Fellowship Foundation papers, Billy Graham Center archives, Wheaton College, Wheaton, Illinois; Norman Grubb, *Modern Viking: The Story of Abraham Vereide, Pioneer in Christian Leadership* (Zondervan, 1961).



Buchman hobnobbed with the Oxford Group in England, and with SS leader Heinrich Himmler in Germany.

Mrs. Marian Johnson, a high-society American and fanatical Anglophile, intimate on a family basis with the British Ambassador to Washington (1938-40), Lord Lothian, head of the financiers' "Round Table" faction promoting Hitler; Mrs. Johnson oversaw much of the fundraising for the Buchman movement;

Abraham Vereide, a Norwegian immigrant and Buchman apostle specializing in capturing the minds of the wealthy and the powerful. He claimed to have converted the former Nazi SS officer, Netherlands' Prince Bernhard, to Christ, and he and Frank Buchman together secured official Dutch Royal Family sponsorship for the Prayer Breakfast movement;

Col. Sir Vivian Gabriel, a British intelligence officer serving as Air Attaché with the British Embassy, who opened doors for Vereide and the others inside Washington;

H. Alexander Smith, the main American lieutenant of Frank Buchman, and father-in-law of Reverend Shoemaker. Smith later represented New Jersey in the U.S. Senate, and cemented the Prayer Breakfast, under covert "Fellowship" leadership, into place as a private institution in the U.S. Congress. On June 2, 1941, a year after the Nazi conquest of France, Smith drafted for the Foreign Policy Association a proposal that Hitler should be allowed to rule over and reform Europe—the so-called New Order—while the United States and Britain should jointly rule the rest of the world.

The Hitler-Haunted House on C Street

The existence of a covert Hitlerite organization (called simply "The Fellowship," or "The Family") wielding considerable power through the 1980s' Conservative Revolution,



The house at 133 C Street S.E., the 1980s YWAM headquarters in Washington, was then and is now the residence for Congressmen hosted by the Nazi Buchmanite movement known as The Fellowship.

was brought before the public in the March 2003 issue of *Harper's* magazine (article entitled "Jesus Plus Nothing").

Reporter Jeffrey Sharlet infiltrated The Fellowship. He quoted the leader, Vereide's successor Douglas Coe, and the group's private memos: "Coe listed other men who had changed the world through the strength of the covenants they had forged with their brothers: Look at Hitler, he said. Lenin, Ho Chi Minh, Bin Laden. . . . A document called Thoughts



FEMA News Photo/Andrea Booher

Ground Zero on Sept. 13, 2001. The ABC TV “docudrama” was a fraudulent portrayal of the events leading up to 9/11, directed by YWAM activist David Cunningham.

on a Core Group explains that Communists use cells as their basic structure. The mafia operates like this, and the basic unit of the Marine Corps is the four man squad. Hitler, Lenin, and many others understood the power of a small core of people. . . . [Coe called for] ‘total unity. Two, or three, become one. . . . It’s called a covenant. Two, or three, agree? They can do anything. A covenant is . . . powerful. Can you think of anyone who made a covenant with his friends? . . . Hitler. Yes,’ Doug said. ‘Yes, Hitler made a covenant. The Mafia makes a covenant. It is such a very powerful thing. Two, or three, agree.’ ”

The repeated message, that barbaric and evil power becomes good when Jesus controls it, was delivered to the residents, a captive audience of the cult, “at the Family’s four-story, red brick Washington town house, . . . at 133 C Street S.E.,” just around the corner from the Congressional office buildings. At the time of the *Harper’s* article, “Eight congressmen, including Senator Ensign and seven representatives lived there. . . .”

In 1985, Congressman Tom DeLay (R-Tex.), then in his first term, was a terrible drunk, his life crashing. The Fellowship/Prayer Breakfast organization took him under its protection and brainwashing regime, as it did with key personnel in the military and elsewhere, a network of far-right intrigue throughout government.

But in the 1980s, the Fellowship was unknown to the public. What then was the official name of the organization running this nightmare on C Street? It was Youth With A Mission.

EIR’s interviews with former YWAM staff members have allowed us a glimpse at the internal operation of the group. The 133 C Street house, the Washington headquarters for

Youth With A Mission, was headed by Ron Boehme (pronounced “Bay-mie”). The program in the 1980s was precisely that described in the 2003 *Harper’s* article, capturing control of Congress and government, using Buchman’s pagan-oracle “talks with God,” etc.

As it happens, this same Ron Boehme, now a YWAM leader in Washington State, is as of the time of this writing, a candidate for state legislature (26th District, Kitsap County) in the Republican primary to be held Sept. 19.

Interviewed by a local publication, candidate Boehme, boasting of his former importance, spoke somewhat openly about the arrangements over the past quarter century at 133 C Street S.E., Washington.

Speaking of himself in the third person, he said “Ron joined Youth

With A Mission—one of the world’s largest youth/service organizations. YWAM has 11,000 full-time staff and 25,000 short-term workers that serve in 140 nations around the world. . . . Ron has founded Youth With A Mission centers in Washington D.C., Virginia, and the state of Washington. . . . He served in Washington, D.C. during the Reagan Revolution, and started a center on Capitol Hill in 1980 that continues to this day and houses 2% of the U.S. Congress (its first resident being Congressman Steve Largent).”⁴

Reporting to London

The international chairman of Youth With A Mission is now Lynn Green, who is also the head of YWAM in England. On Aug. 7, as the group’s hoax 9/11 docudrama was getting set to air on ABC, director David Cunningham spoke about the project at a meeting at YWAM’s International Chairman’s headquarters in Harpenden, England.

Now that the blow has been struck, and 13 million Americans saw the Clinton Administration portrayed on the program as responsible for the 9/11 attack, jubilant YWAM Chairman Lynn Green is preparing his own report. On Oct. 5, Green will be the featured speaker at the 2006 “City Prayer Breakfast.” This is the inner core of the Buchman/Fellowship/Prayer Breakfast initiative: leading private bankers from the City of London financial district, and their allies within the British government and military establishment, a faction using theocratic intrigues for fascism, permanent war, and world empire.

Next week: “The Ugly Truth About John Train.”

4. www.pajamajihad.org/2006/06/personality-project-ron-boehme.html

YWAM Celebrates Founder Frank Buchman

In 1990, Youth With A Mission created an organizational sub-entity called the International Reconciliation Coalition, a psychological profiling initiative aimed mostly at “indigenous people” in the former colonial sector, an initiative modelled on Frank Buchman’s operations in Caux, Switzerland.

The article excerpted below was written May 12, 2003, and is posted on the Youth With A Mission website. It is a story with wildly inflated claims of the importance of Buchman, the notorious pro-Nazi religious faker, in the creation of what became the European Union.

‘Something To Celebrate’

As everybody knows, last Friday (May 9) was Europe Day, occasioning wild celebrations all across the European Union with bonfires, fireworks and all-night dancing.

Well, hardly. I doubt if even a couple of civil servants in their Brussels offices lit sparklers during their lunch-hour. There hasn’t been a lot of celebrating in Brussels since Europe’s “shock and awe” united-front performance during Gulf War Two. (Did you miss that too?)

So what exactly then does Europe Day commemorate?

As a matter of fact, there *is* a wonderful story of forgiveness and reconciliation behind Europe Day, one that we do well to pause and reflect on. Perhaps you’ve heard me tell this before, but it’s worth telling annually around May 9.

We pick up the story towards the end of the Second World War, when ninety-five Swiss Christian families pooled their life-savings to purchase a derelict hotel high in the mountains above Montreux overlooking Lake Geneva. Their vision was to open a Centre for the Reconciliation of the Nations, a refuge of hope. Over the next few years, thousands of politicians and other leaders from across Europe and the world would come through its doors.

Behind this vision, and the movement known as Moral Re-Armament (MRA), was a man named Frank Buchman. An evangelist with global impact, Buchman was acutely aware of the need of reconciliation between the nations of Europe, and indeed the whole world. He knew that if Germany was not embraced by Christian forgiveness and reconciliation, godless forces of anarchy or communism would fill the post-war vacuum.

To one of the summer conferences immediately after the war, he had invited . . . French [resistance fighters] . . . [and] Germans . . . [who were] among the first of over 3,000 leading citizens given special permission by the

Allied authorities to travel to Switzerland to meet their opposite numbers from Europe and other continents. The message of forgiveness and reconciliation taught by Buchman . . . affected them deeply. . . .

Among the visitors the next year was Dr. Konrad Adenauer, the future German chancellor, who invited MRA teams to bring the message of forgiveness to Germany through travelling musical shows. . . .

Meanwhile, the French Prime Minister, Robert Schuman, had heard that . . . remarkable changes of heart were taking place among industrial leaders in the north of his country, where tensions had led to talk of civil war. He traced the changes back to this Centre for the Reconciliation of the Nations. So in 1948 Schuman, who like Adenauer was a devout believer, arranged to meet with Buchman. The Frenchman confided in Buchman that he was discouraged, and was considering retirement. Yet, something told him his life task still lay ahead, that of reconciling France and Germany.

“But which Germans can I trust?” he asked his new friend. Buchman encouraged both Schuman and Adenauer (who had once called the Frenchman a “lying Alsatian”) to trust each other.

This trust culminated in a bold plan, proposed by Schuman, to integrate the coal and steel industries of France and Germany, and of any other European country who wished to join. Since these industries would be the motor of any potential military machine, future war between the nations would be rendered permanently impossible.

Adenauer interrupted a Federal cabinet meeting the same day to announce the plan: “All my life I have fought to reconcile France and Germany. Today Robert Schuman’s generous initiative fulfills all my hopes. This French proposal is in every way historic: it restores my country’s dignity and is the cornerstone for uniting Europe.”

A few weeks later, Schuman decorated Buchman as a Chevalier of the Legion of Honour, in recognition of his role in helping “to create the climate in which the new relationship between France and Germany had been rendered possible.”

This Schuman Plan, presented on May 9, 1950, gave birth to the European Coal and Steel Community, ECSC, the first major step toward the formation of the European Economic Community, which has grown to become today’s European Union. The anniversary of this event is now known as Europe Day, celebrated annually throughout the European Union.

Now, that’s something worth celebrating, don’t you think?

Till next week,
Jeff Fountain
YWAM Europe

Senate Panel Passes Specter Wiretap Bill

On Sept. 13, the Senate Judiciary Committee voted 10 to 8 along partisan lines for a bill sponsored by committee chairman Arlen Specter (R-Pa.) that would give the Foreign Intelligence Surveillance Act Court the jurisdiction to decide whether or not the National Security Agency domestic wiretapping program is Constitutional, but doesn't require the President to submit the program to the court for review. Specter went ahead with the bill, however, on the basis of a promise from President Bush that he would do that.

The committee otherwise rejected, along partisan lines, all Democratic amendments, all of which sought to increase Congressional oversight in other ways. As Sen. Russ Feingold (D-Wisc.) noted early during the committee debate, "None of us have enough information to legislate on this."

The committee also acted on three other bills related to the NSA surveillance program. The committee passed, on a 10-8 vote, a bill sponsored by Sen. Mike Dewine (R-Ohio) that would authorize the President to establish a terrorist surveillance program if it meets certain criteria. The committee rejected, on a split 9-9 vote, a bill by Sen. Charles Schumer (D-N.Y.) that would give standing to anybody who feared that his telephone calls were being monitored.

Finally, the committee passed, 10 to 8, a bill co-sponsored by Specter and Sen. Dianne Feinstein (D-Calif.) that reinforces FISA as the exclusive authority over NSA wiretapping, after rejecting, by an 8 to 10 vote, an amendment by Sen. Jon Kyl (R-Ariz.) that would've gutted that provision of Feinstein's bill.

A week earlier, Specter had pulled his bill from committee consideration

partly because of Feingold's opposition. Feingold had mocked the plan as equivalent to Bush saying: "I'll agree to let the court decide if I'm breaking the law if you pass a law first that says I'm not breaking the law." The main factor behind Specter's withdrawal of the bill was that three Republicans, Senators Larry Craig (Id.), John Sununu (N.H.), and Lisa Murkowski (Ak.), none of whom is a member of the committee, signed a letter with Sen. Patrick Leahy (D-Vt.) and other Democrats, demanding further hearings before a vote.

Bond, Leahy Warn Against Martial Law Provision

Senators Kit Bond (R-Mo.) and Patrick Leahy (D-Vt.), co-chairmen of the Senate National Guard Caucus, wrote to the chairmen and ranking members of the Armed Services Committees of both houses urging them to reject provisions in the defense authorization bill that would make it easier for the President to declare martial law. The provisions at issue amend current law so that the President can call up the National Guard or reserve forces to respond to a natural disaster.

Bond and Leahy said that adding such a specification makes it easier for the President to declare martial law, "which goes against one of the central tenets of our society." They write that the President already has authority to use the military to restore civil order under the Insurrection Act, an authority which has only been used sparingly in American history. The proposed legislation, however, "changes the presumption against invoking martial law to a presumption for the domestic use of the military in our states and communities."

Bond and Leahy also warn that the

provisions undermine the time-tested principle that the executive closest to the disaster, a mayor or governor, has responsibility to handle it, and other assets are deployed in support of that executive. However, the provisions in the House and Senate bills would make it more likely that the President would be in charge by virtue of his control of the military. They also note that no hearings have been held on either the House or Senate provisions. "It does not make sense to give the President more authority to invoke the Insurrection Act and to call martial law without understanding the consequences of any change."

Hearings Become Debate on Rumsfeld

Senate Democrats turned the debate on the defense appropriations bill, which the Senate had not completed prior to the Summer recess, into a debate on the competence of Secretary of Defense Donald Rumsfeld. On Sept. 6, Senate Minority Leader Harry Reid (D-Nev.) sponsored an amendment that called on President Bush "to change course in Iraq to provide a strategy for success." An indication of such a strategy would be the replacement of Rumsfeld as Secretary of Defense.

Reid said that the amendment was "bigger than Donald Rumsfeld": "This is about changing course in Iraq and the President demonstrating to the American people he understands America cannot stay the course when the present course is taking our country in the wrong direction."

The Democrats' determination to debate Rumsfeld's tenure followed a series of speeches he made in August, comparing those who disagree with the Bush Administration's policy to

the appeasers of Adolf Hitler and Nazism during World War II. "These assertions were offensive and indicative of a Secretary of Defense who has lost his way, who is not capable of overseeing America's defense or certainly a new direction in Iraq; who is more concerned, it seems, with the Bush Administration's political fortunes than the safety and security of the American people, and who must be replaced," Reid said.

Reid's amendment was ultimately ruled "non-germane" with respect to the appropriations bill, on a point of order made by Sen. Ted Stevens (R-Ak.), the chairman of the Defense Appropriations Subcommittee, but not before it touched off lengthy and often passionate statements from both sides of the aisle.

Pentagon Officials Grilled on Iraq

Rep. Chris Shays (R-Conn.), the chairman of the National Security Subcommittee of the House Government Reform Committee, began three days of hearings on security in Iraq, focussed on the question of when U.S. troops can be withdrawn. Both Shays, who, last month, began to call for a withdrawal timetable, and Rep. Dennis Kucinich (D-Ohio), the ranking Democrat on the panel, agreed, in their questioning of the witnesses, that conditions in Iraq have only been getting worse, and that U.S. policy in Iraq is part of the reason. Shays said he was in Iraq in April of 2003, and "If we had made progress at that point, I think we probably wouldn't be there in any great number, today." He cited, among other things, the disbanding of the Iraqi army and police after the fall of Baghdad, a decision which, he said, "to this day boggles my mind."

Kucinich seized on an article that appeared in the *Washington Post*, that morning, on a report by a Marine Corps intelligence officer who concluded that the prospects for securing Iraq's Anbar province "are dim and that there is almost nothing the U.S. military can do to improve the political and social situation there." Kucinich grilled Undersecretary of Defense Eric Edelman on the significance of the report, but grew increasingly frustrated because Edelman would not quote from the report because it is classified. "Wouldn't it be of interest to the parents of American soldiers who are being sent to fight that they would know that a report existed that said that a province was beyond repair and the thing couldn't be won militarily?" Kucinich demanded. Edelman replied that "We've taken it very seriously," but described it as a "snapshot in time" that does not represent the entire country.

Murtha Slams Rumsfeld On Military Readiness

On Sept. 13, Rep. John Murtha (D-Pa.) released a report documenting the collapse of Army readiness. Army brigades are turning around between deployments in less than a year, and are unable to fully retrain because they lack the equipment, especially armored vehicles and trucks, which have been worn out in Iraq and Afghanistan, causing them to be redeployed at less than full combat readiness. "In effect," Murtha says, "the Army has become a 'hand-to-mouth' organization. Its inability to get ahead of the deployment and training curves is rooted in the Administration's miscalculations and blind optimism about troop and industrial surge requirements for the U.S. occupation of Iraq."

Murtha also reported that while the Army is meeting its recruiting and retention goals, the measures it is taking to do so may be resulting in a lower quality force. He says that company commanders are reporting that disciplinary actions resulting from drug and alcohol abuse have skyrocketed in the past year. "To suggest that the Global War on Terror will last for years, yet fail to even acknowledge—let alone take steps to address—the Army's readiness, equipment, and personnel shortfalls, is viewed as short-sighted at best. At worst, the future security and deterrent power of the United States is dangerously at risk," Murtha concluded.

In conjunction with the report, Murtha also introduced a resolution in the House, calling for Rumsfeld's resignation "for the good of the country," and to "restore credibility both at home and abroad."

The resolution says: "The first step in restoring that credibility must be to demonstrate accountability for the mistakes that have been made in prosecuting the wars in Afghanistan and Iraq"; to "reconstitute our military readiness, and refocus on the threats to national security posed by diffuse and proliferating terrorist cells as well as belligerent states."

The resolution blames Rumsfeld for the failure to capture Osama bin Laden during the battle for Tora Bora in December 2001, by failing to commit sufficient troops; failure to ensure adequate body armor and protective gear for troops in Iraq; failure to anticipate the troop strength required; failure of training and supervision, which led to abuses at Abu Ghraib; failure to address flagging readiness of U.S. ground forces; and failure to ensure adequate accounting of billions of dollars of Coalition Provisional Authority expenditures.

Iran: Turning the Tables On the War Party

by Muriel Mirak-Weissbach

Those neo-cons in Washington who are itching to let the bombs fly on Iran, have been hit with two important documents, which effectively expose the campaign of lies and manipulation mounted to justify belligerent action against the Persian Gulf nation. The two documents are the reply, by the Iranian government, to the incentives offer, made by the so-called 5+1 group—the five permanent members of the UN Security Council, plus Germany—and a letter by the International Atomic Energy Agency (IAEA) to Congressman Peter Hoekstra, refuting claims made by a report of the House Permanent Select Committee on Intelligence, about Iran’s nuclear program. The two documents provide powerful ammunition for those seeking to prevent a new war in the region, and to settle the conflict over Iran’s nuclear program, through rational negotiations.

Iran issued its formal reply to the 5+1 incentives package on Aug. 22, but it was made public only on Sept. 12, on the *isis* website. It appeared on the Internet just days after Ali Larijani, head of Iran’s Supreme National Security Council and chief negotiator on the issue, had held meetings over two days with European Union (EU) foreign policy chief Javier Solana, representing the 5+1. The talks, in Vienna, focussed on the offer and the Iranians’ reply; although no details were released, both sides expressed their satisfaction with the talks, which clarified the “ambiguities” (Solana) and “misunderstandings” (Larijani) related to the issue.

At the same time, an unnamed EU diplomat was quoted saying that Larijani had offered a two-month suspension of uranium enrichment. The report was promptly denied in Tehran. Then the document appeared on the Internet, indeed showing that Iran would be ready to suspend uranium enrich-

ment, in the course of negotiations, but not as a precondition to the same.

The message coming out of the talks, was clear: The matter *can* and *should* be solved diplomatically, without recourse to violence. IAEA head Mohamed ElBaradei, who was briefed by Larijani on the talks, presented a report to the IAEA governors board on Sept. 11, in which he stressed that “negotiation is the best option to find a durable solution.” He expressed his hope that Larijani and Solana, in their next round of talks, would reach an “agreement to go back to the negotiation table.” The Iranian representative at the IAEA also reported to the board of governors meeting, stressing Iran’s willingness to open full negotiations, a position repeated by President Mahmoud Ahmadinejad.

Predictably, U.S. Ambassador to the IAEA Gregory Schulte pushed for referring the affair to the UN Security Council, where U.S. Ambassador John Bolton is ready to present a resolution for sanctions. But Solana put on the brakes, stating that as long as talks took place with Larijani, there was no perspective for sanctions. Russian Foreign Minister Sergei Lavrov declared, “It is irrational to talk to Iran in the language of ultimatums.” Days later, Lavrov said sanctions should be seen as a last resort—as should the use of the veto at the Security Council, hinting that Moscow might have recourse to its veto power. Lavrov emphasized that he hoped contacts between Solana and Larijani would “produce a result that will make it possible to resume negotiations.”

Tehran Replies

The document issued by Iran is sound, and undercuts the propaganda line that Iran is merely trying to “buy time,” or



Hesham Aramdeh

Ali Larijani, Iran's chief negotiator on the nuclear issue, met with European Union foreign policy chief Javier Solana Sept. 9-10, and both sides reported progress in negotiations. Shortly thereafter, Iran made public its formal reply to the proposals of the UN Permanent Five plus Germany.

hoodwink the West, etc. Given that the press coverage has reduced the document to a few points, deliberately excluding other crucial points, it is important to review the text in some detail. The main points made in the document are the following:

Iran has to be dealt with as an equal. Its membership in the IAEA and the Non-Proliferation Treaty (NPT) have to be taken seriously; "To deny rights and privileges is to defy reasons for membership. No government can assume rights to herself while depriving others of the same. And no government can presume responsibilities for others while relieving herself from the same." I.e., no double standards.

The document states that Iran opposes all weapons of mass destruction and has no intention to develop them. If funds allocated for these systems were allocated differently, the "causes of insecurity, instability and injustice" could be removed and replaced by "peace and security, justice, peaceful coexistence and welfare. . . ."

When presented the 5+1 offer, Iran took an "engagement approach," and deployed expert teams to work on it. Iran-EU contacts proceeded, and "No precondition or ultimatum was raised by either side during this period." Then, as things were moving ahead, the Security Council resolution was pushed through, which meant a resumption of the "confrontational and threatening approach . . . just as the region faced a crisis." This undermined confidence, and placed the entire NPT regime in jeopardy. "To resolve the issue at hand in a sustainable manner, there would be no alternative except to recognize and remove the underlying roots and causes that have led the two sides to the current complicated position. When right versus trust forms the basic approach in considering the nu-

clear program of a State, and this serves as pretext for denial, discreetness in the program would naturally ensue; as the other side may never be willing to concede its confidence and trust. Conversely, a legal and fair approach, entailing unimpeded access to peaceful nuclear technology, would prompt transparency and full monitoring."

Iran states that it has no intention of hindering inspections. It developed its program in "independence and self-reliance," at times discreetly, because of the hostile attitude of others.

The document reiterates the point that Iran has a right to develop the full nuclear fuel cycle. "Nuclear fuel is destined as a strategic commodity in the future of world energy. As major European countries continue production of this commodity through heavy investments and large subsidies, Iran too expects that its substantial investments will lead to production so that it would not have to depend on exclusive suppliers. . . . Self-reliance, however, does not exclude cooperation and partnership. Iran's nuclear program is entirely open to joint investment, operation, development, and production. As the President has declared, the Islamic Republic [I.R.] of Iran is prepared to implement its nuclear program through consortium with other countries."

Iran has a nuclear program for the next 20 years, of which details are given. Due to sanctions in the past, Iran demands the right to have the full cycle.

Regarding the June proposal of the 5+1, Iran reiterates its rights according to the NPT, and declares its readiness for "negotiations as a new beginning to reach a 'comprehensive agreement' with Iran." It sees the 5+1 proposals as having constructive ideas but also ambiguities. Iran is "prepared for removing concerns of the two sides through negotiations and receiving clarifications on the nature, extent, approach, level, duration, and depth of issues in the offer such as real and practical cooperation in development of Iran's peaceful nuclear program, including light and heavy water reactors, and exercise of Iran's right to achieve nuclear energy inclusive of the fuel cycle and continuation of research and development in uranium enrichment."

Offer of Regional Cooperation

The most important aspect of the document relates to what Iran could contribute to stabilizing the explosive Southwest Asia region, in the event that a reasonable agreement were found regarding its nuclear program. It states: Iran "is ready for long-term cooperation in security, economic and political and energy areas in order to achieve 'sustainable security in the region' and 'long-term energy security.'" The "region" referred to here includes Iraq, Afghanistan, Lebanon, Palestine, and Israel. The document reiterates the idea, saying, for example, that Iran sees in the proposal the possibility for solving everything through negotiations, and also "to promote peace and security in the region and scientific, technological and economic progress in Iran."

Iran “accepts the core idea of the proposal,” believing all problems can be solved through negotiations and mutual confidence. However, “Clear evidence and experience gives reason to Iran to remain seriously skeptical towards sincerity of at least some members of the 5+1 in their declared intention to establish comprehensive relations and cooperative exchanges. Iran believes, therefore, that these governments should come forward with assurances, commitments, and indications that demonstrate revision in past behavior and absence of intentions to contain Iran or seek a pretext for hostile actions in advance of the negotiations.” This means Iran wants security guarantees that it won’t be nuked or otherwise attacked.

For the negotiations to be fruitful, Iran says the “extent and limitations on the authority of each negotiator should be defined and declared formally” to be clear on what is being negotiated. Iran criticized the 5+1 proposal for the following: It “lacks any reference to irreversible and irrevocable guarantees which should be attached to the undertakings. Such guarantees are particularly essential on access to advanced nuclear technology and equipment, erection and commissioning of nuclear power reactors, nuclear fuel supply, and transfer of know-how and technology. For Iran, it should become clear that the undertakings of our counterparts would become permanent, with no right or possibility to their termination or limitation, in the context of export controls, NSG [Nuclear Suppliers Group], domestic laws and regulations, and the procedures of the IAEA and the United Nations.”

The two main processes involved are “Iran’s interaction and collaboration with the IAEA,” and “The process of negotiations between Iran and its counterparts.” Here, ambiguities have to be clarified.

Iran posits three fundamental principles for the talks: “First The Islamic Republic of Iran has the right to pursue its intended peaceful nuclear Program, including all its activities on the fuel cycle with peaceful purposes, within the framework of NPT and under Agency safeguards. Second: The Islamic Republic of Iran, as an NPT party and an IAEA member, is obligated to comply with all its commitments under its bilateral agreement with the Agency and to prepare conducive conditions for the IAEA to perform its responsibilities vis-à-vis Iran’s activities. Third: As an IAEA member, Iran has the right to receive active support in areas of science, technology, investment, and trade from developed countries in the nuclear field, in accordance with the NPT provisions and its regulations. Conversely, all interlocutors with capabilities in nuclear technology are obligated to remove all impediments in peaceful nuclear cooperation with Iran in implementation of their commitments.”

Regarding the issue of enrichment, Iran says: “The proposers of the package, having considered some commitments and measures to be undertaken by both sides before the

start of negotiations, ‘to create the right conditions for the negotiations.’ . . . The remaining issue is suspension of Iran’s dossier in the Security Council during the negotiation period by the other party, and suspension of enrichment activities by Iran through negotiations. I.R. Iran essentially agrees with consideration of some principles and conditions for further assurances of productive negotiations and considers that as a correct step.”

Iran says the issue must not be sent to the Security Council. “I.R. Iran fundamentally rejects the use of the Security Council resolution as a pressure tool to push forward the P5+1 proposal, and considers this practice as distortion and negation of the initial intent, and would not concede to it. Any progress in this course, would only be possible by separation of these two issues, namely disengagement of any negotiations from unjustified resolution of the Security Council.” Iran states it is ready to discuss the issue.

Iran wants the guarantees that are in the NPT, and in turn would consider implementing the additional protocol. Furthermore, “Iran is ready to illustrate its goodwill if it received responsible and logical behavior from the other party, to guarantee in an appropriate manner, that it would not abandon its membership in IAEA and NPT, and through this way, commits itself even to the future aspect of confidence building.”

Security is a key issue: confidence building for Iran means considering the following: “A) The other party’s commitment to seriously follow up the fulfillment of the nuclear free zone in the Middle East, particularly the commitment to disarm the Zionist regime from weapons of mass destruction (WMD) and in particular nuclear arms. B) The other party’s commitment to convince the countries of the region (Middle East) who are not yet signatories to NPT, or are not yet implementing the Additional Protocol, to accept NPT membership, and to implement the Additional Protocol. C) The commitment and guarantee of the negotiating partners to prevent and protest all hostile and restrictive acts against I.R. Iran including any scientific, technical, political, economic, and commercial embargo and any kind of military aggression or threat.”

A change in policies is required vis-à-vis Iran—i.e., embargoes and sanctions must be lifted. “Fortunately, Iran has active and extensive relations with China and Russia. There are also trade and diplomatic relations with major European countries which have experienced some restrictions in some cases. The available data indicates that the majority of the P5+1 do not have inclinations for political use of trade and economic means, and in their general policies, there is no priority set for deprivation or restriction policies against Iran. Although some states, not only unacceptably exploit restrictive policies against Iran, but also abuse their technical and trade leverage to force other governments and third country companies to participate in these

anti-trade practices despite their own national policies. Therefore at least the main part of the proposed issue in this section is not essentially a case between Iran and the other party, but it is a case for the other party to settle amongst themselves.”

Regional security is discussed in more detail: “The I.R. Iran is ready for a comprehensive and long-term cooperation agreement to achieve ‘sustainable development and security in the region,’ based on fair terms and conditions, attending to the rights of all countries, and *would contribute to the highest extent possible to participate in effective security arrangements in an all-inclusive model, with all its potential as a responsible state, an active member of the international community, having an effective regional role*” (emphasis added). “On this basis, I.R. Iran is ready to have an active role in a cooperation arrangement for ‘sustainable energy security’ to have extensive cooperation and partnership with the European countries and other countries of the region.”

IAEA Strikes Back

As the neo-con warmongers’ camp continued to harp on the need to rapidly refer the matter to the UN Security Council—i.e. to move for sanctions immediately, wise words of caution came from UN Secretary General Kofi Annan, who, following a tour of the turbulent region, reported that government leaders he had met, feared that the Iran crisis could escalate from sanctions to war, as the case of Iraq showed. Annan warned against this.

The case for imposing sanctions on Iran could only be made if Iran were violating the NPT and other IAEA regulations. Thus, putting the truth on the table is crucial. Herein lies the significance of the second document to be considered, which is the IAEA’s response to the Staff Report of the Subcommittee on Intelligence Policy, of the U.S. House Committee on Intelligence, dated Aug. 23, 2006. That the international agency issued a public response to a staff report of a Congressional subcommittee is unusual in itself. The IAEA letter, dated Sept. 12 (right after the Solana-Larijani talks, and the same day the Iranian reply was published), says that the Staff Report “contains some erroneous, misleading and unsubstantiated information.” And the specific cases of such lies are listed and systematically refuted.

First, the Staff Report states, in a caption under a picture of the Natanz nuclear site in Iran, “Iran is currently enriching uranium to weapons grade using a 164-machine centrifuge cascade.” The IAEA states that the work conducted there, “including the 3.6% enrichment level that had been achieved,” had been communicated to the IAEA in April. Furthermore, “The description of this enrichment level as ‘weapons grade’ is incorrect, since the term ‘weapons-grade’ is commonly used to refer to uranium enriched to the order of 90% or more in the isotope of uranium-235.”

Secondly, the Staff Report says that “Iran had covertly produced the short-lived radioactive element polonium-210 (Po-210), a substance with two known uses: a neutron source for a nuclear weapon and satellite batteries.” The IAEA retorts that the use of the word “covertly” is “misleading because the productions of Po-210 is not required to be reported by Iran to the IAEA.”

Thirdly, there is the outright lie, and vicious insinuation that the IAEA is complicit in covering up illegal nuclear work! The “IAEA Secretariat takes strong exception to the incorrect and misleading assertion in the Staff Report’s second full paragraph of page 13 that the Director General of the IAEA decided to ‘remove’ Mr. Charlier, a senior safeguards inspector of the IAEA, ‘for allegedly raising concerns about Iranian deception regarding its nuclear program and concluding that the purpose of Iran’s nuclear programme is to construct weapons.’ In addition, the report contains an outrageous and dishonest suggestion that such removal might have been for ‘not having adhered to an unstated IAEA policy barring IAEA officials from telling the whole truth about the Iranian nuclear program.’ ”

In point of fact, the IAEA explains, according to the safeguards agreement between states and the IAEA, member-states have “the right to object to the designation of any safeguards inspector, and to request the withdrawal of the designation of an inspector, at any time.” This is what happened. The IAEA goes on to note that Iran has accepted over 200 such inspectors, which is what most states also have done.

The last point made by the IAEA, is that it regrets that the Staff Report ignored a statement in a UN Security Council resolution (1696), which “commends and encourages the Director General of the IAEA and its secretariat for their ongoing professional and impartial efforts to resolve all remaining outstanding issues in Iran within the framework of the Agency.” The letter concludes that the IAEA remains “ready to assist your Committee in correcting the erroneous and misleading information contained in the report.”

No Iraq Replay

Clearly, forces in the UN, especially Russia and China, are fully aware of the danger that the attempt to produce fabricated “intelligence” or, more bluntly, lies, regarding Iran’s alleged nuclear weapons ambitions, could be used, as in the case of Iraq, to hoodwink political bodies to accept war. Other forces in the UN—to wit, the IAEA and its Director General ElBaradei—have learned the lessons of the Iraq War, and are committed to preventing a repeat of that crime. Thus the unusually strong response to the staff report.

It should come as no surprise that the person who drafted that report was Fredrick Fleitz, identified by the *Washington Post* on Sept. 14, as a former CIA officer who was a special assistant to John Bolton.

CONGRESS WILL HAVE TO ACT

Ford Is Repeating Delphi's Destruction As Auto Sales Fall

by Paul Gallagher

With the announcement by the United Auto Workers to its locals on Sept. 14, of a massive retirement buyout by Ford Motor Co. across its entire North American production workforce, and with a late-August plunge in U.S. auto sales across the board, the auto industry's collapse in the United States is picking up speed. If Ford's buyout washes out of the industry the now-targeted 30,000-35,000 of the company's 80,000 production employees, along with additional mass firings and plant closings announced Sept. 15, Ford will have done a "second Delphi Corp.," shrinking and globalizing itself to the point where it is a U.S.-headquartered firm with 85% of its workforce overseas. And the overall U.S. auto industrial sector would be shrinking by close to 15% a year by the end of 2006.

Up against elections with most of remaining U.S. industry "getting killed" by globalization, and with the auto industry and housing sector forming the leading edge of a rapidly sinking economy, Congress must be forced to act. This is an issue of the entire lower- and middle-income 80% of the U.S. population; as Lyndon LaRouche set out the Democrats' situation in his Sept. 6 broadcast, if they do not act in September and October on behalf of this "lower 80%," they will forfeit the economy and the elections. LaRouche's Economic Recovery Act of 2006, to retool the closed and closing auto plants for an economic infrastructure mission, is the effective Congressional intervention in the crisis.

Globalization In Extremis

Delphi, General Motors, and Ford—including its largely re-absorbed Visteon Corp. supplier—alone had already marked 60 plants in North America for closure or sell-off

before the mid-September announcements, and their retirement buyouts had already removed over 60,000 production workers from the industry this year. Ford may eliminate another 35,000 by this workforce-wide buyout, and is also going to fire 10,000 more salaried employees, including engineers and designers. It is triggering lay-off announcements and production cuts by Visteon and other suppliers, by its own announced production cuts of 11% in the third quarter and 21% in the fourth. GM has announced a 12% fourth-quarter production cut. Chrysler is next into the tank: It has a huge 93 days-worth national inventory of unsold cars and trucks.

The immediate cause of the drastic auto shrinkage—and the one which cuts off any way out *other than* the "new production mission" LaRouche proposes—is the global phenomenon of sinking sales. Although developing-country markets have rising sales, they do not begin to overcome the auto industry's international predicament: Japan auto sales down 9% so far in 2006; Europe auto sales down 3% for the year to date; United States auto sales down nearly 5% for the first eight months of the year. This is the marker of globalization in its extreme: falling real wages worldwide. And the fall is accelerating. In the United States, as even sharp-eyed industry predator Wilbur Ross has recently noted, the housing bubble collapse is directly cutting auto sales as well, taking the illusion of disposable income out of the household budget, cutting construction activity and therefore truck sales, etc.

The industrial analysis firm Global Insight, Inc., in an auto industry report and webcast on Sept. 7, said that the "U.S. auto sales market has downshifted in August," reaching a very poor and unexpected SAAR (annual sales rate) of 16 million, and bringing the SAAR for the year to date down to just

over 16 million. Furthermore, the firm's analysts reported in worried tones, "the pace of sales weakened considerably in the closing weeks of August," and "all [makers'] production schedules are in jeopardy."

Global Insight now estimates/forecasts a total production cut, by all automakers combined in North America, of 4.6% in the third quarter, and 6.5% in the fourth quarter. Total auto production (assembly and engine) in North America has fallen from 16 million units in 2003, in steps, down to 15.44 million projected this year, and that could fall further; of that falling North American production, assembly in Mexico and by foreign automakers in the United States, has risen from 4.1 million in 2003 to 5.1 million in 2006. Capacity utilization by the Big Three automakers has fallen in 2006 to 77% (in the third quarter, to 74%) despite closures of seven assembly, engine, and transmission plants in 2005 and 2006; that is, one-quarter of the remaining total capacity is still unused.

These analysts blame all this on oil/gas prices and "higher interest rates," and simply assume that production will start rising again after 2007. But their surprise at the rate of fall was palpable. And in fact, while auto sales were taking their nosedive in August, interest rates and gas prices were falling; they have continued to fall during September, but industry analysts and parts-industry sources now see total auto sales falling again in September. The fundamental problem is falling household real incomes, against huge burdens of household debt, as the housing and other bubbles collapse.

Ford's Shrinkage Planners

The sales plunge and the potential prospect of GM's linkup with Nissan and Renault in an international auto cartel, seemed to drive Ford's management into panic—although the much-touted GM/Nissan supercompany would, in fact, bring together three firms, all of whose sales are sliding.

As in the Delphi case of industrial self-destruction, an investment bank appears to be at the center of planning the rapid shrinkage of Ford in North America. With Delphi, it was synarchist banker Felix Rohatyn who designed the "globalization by bankruptcy" plan. With Ford, it is Treasury Secretary Henry Paulson's Goldman Sachs, which has had a powerful position on Ford's board ever since the death of founder Henry Ford.

As soon as it announced big second-quarter losses, Ford hired Goldman Sachs banker Kenneth Leet to work directly with Chairman and CEO Henry Ford III, to design a "restructuring." Then, according to several accounts, one of Goldman's two representatives on the Ford board, John Thornton, hooked up with former Congressman Dick Gephardt (who now consults for Goldman Sachs, among other things), to replace Bill Ford with a new CEO, Alan Mulally from Boeing—where he was no stranger to large-scale layoffs and outsourcing over the past five years.

It was Mulally who announced the firings, shutdowns and

mass buyout offer on Sept. 15. Ford had already announced in January 2006, the shutdown of seven plants by 2008, and has since named six of them, two of which have been shut down during this year. Now seven more plant closings, which were supposed to be out in the 2012 time-frame, have been made immediate. But only two of the new shutdowns were identified: the Ford metal-stamping plant in Maumee, Ohio, and the engine plant in Essex, Ontario. The shutdown of the Norfolk, Virginia truck plant, already announced, was moved up from 2008 to 2007.

Ford appears to be holding back naming the additional five shut-down plants—Ford truck assembly plants in Kentucky, Michigan, and Ontario, stamping plants in Michigan and elsewhere are rumored—to "whip-saw" the union locals at those plants into renegotiating their contracts to attempt to keep work. Two locals in Michigan have already done so during September.

For the UAW locals, seeing clearly that these plants are on the chopping block, the mass buyout plan became a desperation objective, an alternative to more than 30,000 layoffs. The buyouts provide workers near retirement with \$35,000 bonuses to quit now, and offer up to \$140,000 to less senior workers to leave the industry—losing retirement health benefits and giving up part of their pensions—just as in the Delphi case.

But the buyout plan just as surely means drastic shrinkage and shutdown. The only actual alternative, is the one LaRouche has put before Congress in the Economic Recovery Act of 2006. Before the U.S. auto collapse becomes irreversible, Congress will have to act.

Chrysler Lays Off 6,000 In Detroit—'Temporarily'

The layoff of nearly 6,000 United Auto Workers at Chrysler plants in metro Detroit is being billed as "temporary." Some layoffs will last through at least Oct. 19. Whether the workers are brought back, purportedly depends on demand for the vehicles.

Nearly 2,800 workers who produce the Jeep Grand Cherokee and Jeep Commander at Chrysler's Jefferson North Assembly Plant received layoff notices Sept. 14. "Whether it lasts longer [than Oct. 19] would depend on whether there is demand for more of the Jeeps made at the Conner Avenue plant," the *Detroit Free Press* reported Sept. 15.

The same day AP reported that DCX forecasts a \$1.52 billion loss for Chrysler Group in the third quarter.

The U.S. Electric Grid Is Reaching the End Game

by Marsha Freeman

This Summer, three decades of underinvestment and looting of the U.S. electrical industry grid system came home to roost. A week-long blackout in New York City, calls for “voluntary” conservation, the shutting off of power to large industrial enterprises, and lowering of voltages across the nation, were all evidence of the wreckage that has been made of this most critical infrastructure.

For the past three decades, financial warfare, and attacks by anti-technology fanatics and free-market ideologues, have created the “perfect storm” that has left the U.S. electric grid in a condition of increasing instability. The restructuring of the electric utility industry, begun during the mid-1970s Carter Administration, has changed the rules of the road that had created an electric generation and delivery system that was the envy of the world.

This wreckage was accomplished by changing the axioms. From the time of President Franklin Roosevelt’s regulation of the industry in 1935, the intention of the engineers who designed the electric grid was to deliver reliable, economical electricity, to every farm, family, and factory in the United States. Now this extraordinarily complex and fragile system has been degraded into a hodgepodge of hundreds of competing interests, run not by engineers, but by financiers and lawyers, where states are increasingly losing regulatory oversight, and reliability has taken a backseat to shareholder values.

Wheeling Power

The first sector of the electric utility industry to be deregulated was the network of high-voltage transmission wires, which were designed to make bulk power transfers, over relatively short distances, from large power-generating plants to the cities and towns where the power was needed. They were built by the utility company that had built the power plant, and as the grid grew, local lines were connected to other utilities’ power lines to be available in case of emergencies. During the 1977 blackout in New York, for example, power was transferred in from the Tennessee Valley Authority system in the Southeast, to restabilize the grid.

After the mid-1970s Middle East War and orchestrated “oil crisis,” which quadrupled prices, the Carter Administration proposed, and Congress passed, the 1978 Public Utility

Regulatory Policies Act, which promoted “conservation,” and poured billions of wasted Federal dollars into the development of small non-utility power generators, using “non-traditional” sources of power, such as biofuels, solar, and wind energy. This insane turning back the clock to pre-industrial 19th Century methods was reinforced by attacks on nuclear power, reversing the policy of massive additions of new nuclear plants then underway. The 1978 law required the traditional utility companies to purchase power from these expensive “alternative” power sources.

The utility companies objected to this potential anarchic use of the transmission grid, and refused to provide these non-utility generators access to their systems. So, the Federal Energy Regulatory Commission, which had been established to restructure the industry, promulgated a superceding Federal rule forcing “open access” for these new non-utility generators to the transmission system.

This “open access” rule was the foot in the door for the chaos and congestion in the transmission system that exists today. One of the huge electric industry conglomerates, American Electric Power, is an instructive case in point.

On Dec. 20, 1906, a certificate of incorporation was filed in Albany, New York for the American Gas and Electric Company. Over the ensuing 30 years, the company began electric, gas, water, steam, transit, and even ice services, in New Jersey, New York, Pennsylvania, West Virginia, Virginia, Ohio, Indiana, Michigan, and Illinois.

In 1928, the Federal Trade Commission launched a comprehensive inquiry into the entire electric power industry, as abuses mounted, from financial pyramid schemes and the stock market speculation of the “Roaring Twenties.” The investigations culminated in the 1935 passage of President Franklin Roosevelt’s Public Utility Holding Company Act, which forced the breakup of many holding companies, and several of American Electric Power’s holdings were divested. Other legislation made it incumbent upon utilities to provide universal service, and gave the states overall regulatory oversight. While what became American Electric Power still maintained operations stretching from Virginia to Michigan, each state regulated its utility companies, defined the level of reliability to be maintained, and, in return, assured each company a modest return on investment.

AEP built the first high-voltage transmission line, between Muncie and Marion in Indiana in 1911, the first long-distance line, transmitting electricity from a coal mine mouth plant, and the first commercial nuclear power plant on Lake Michigan, at the two-unit Donald Cook station, in the early 1970s. The wheeling of power, which is the transfer of electricity from one supplier over the transmission lines of another system, to where it was needed by a third customer, was used by regulated utilities to increase the reliability of regional grids, in case of an unscheduled shutdown of large generating units, such as from storms or other acts of nature.

But deregulation was marching on.

In 1992, the National Energy Policy Act created another class of non-regulated electricity producers, known as exempt wholesale generators. This broadened the authority of FERC to wrest control of the industry from the utility companies and the states. As has often been noted, FERC has never met a utility merger it didn't like. More and more companies were exempted from the restrictions of the Public Utility Holding Company Act, as mega-monopolies were formed to wheel, not just electrical power, but newly concentrated economic and market power.

In 1995, FERC proposed another rule to mandate open access, this time by any producer, to the transmission network. Under Order 888, implemented the following year, the wheeling of electricity, through multiple transmission systems, over any distance by any generator, was fair game. The Order "unbundled," or segregated, electrical energy generation from the transmission systems the generators had built. For the first time, "economy transfers" were enabled. The transmission grid would be used to enforce "competition."

If a utility, such as the far-flung AEP, could buy power halfway across the country that was even marginally cheaper than what it could produce locally, it could wheel that power hundreds, or thousands of miles to its customers. Even the largest utility holding company today, Exelon, owns only about 5% of the nation's electric generating capacity, with AEP coming in third. But it is not the size of the concentration of electrical power capacity that is creating the chaos; it is the "free market" concentration of economic power, which allows a handful of companies to maximize profits by buying up power lines, looting infrastructure through disinvestment, and setting prices to maximize profits.

At the same time that FERC was tearing apart the 50-year-old regulatory compact between producers and consumers for providing reliable power, states were being convinced by pirates waiting in the wings—most aggressively, Enron—that electric bills to their citizens could be lowered by forcing incumbent utilities to divest themselves of their generating capacity, and sell their assets off to unregulated holding companies, which would buy power for them through a "spot market in electrons."

As the North American Electric Reliability Council (NERC) warned a decade ago, the transmission system was

not designed to handle rapidly-changing bulk, so-called "economy" power transfers. On the three-year anniversary of the "Great 2003 Blackout," NERC vice president Donald Cook explained, "There's no question that the grid is being used now in ways for which it wasn't really designed. It was built to connect neighbor to neighbor, over the last several decades. It was not designed to move large blocks of power from one region to another."

The Federally built Tennessee Valley Authority system is illustrative. TVA built, owns, and operates 17,000 miles of transmission lines, to service its customers over an area including all or parts of seven Southeastern states. FERC has been trying to force the TVA to join a Federally regulated Regional Transmission Organization, which would require it to cede control of its transmission grid, and force it to build new transmission capacity (for which its customers would have to pay), not to service its own ratepayers, but to allow "economy" wheeling over its wires. So far, the TVA has refused.

It is often stated that the solution to this congestion is to build new power lines. But while more capacity is certainly needed, that in itself, will not solve the problem.

Blackout Blowback

Following the August 2003 blackout, which left 50 million people from the Midwest to the East Coast in the dark, multiple Congressional hearings and a Federal investigation were conducted to examine the problem and propose solutions. The Department of Energy was tasked with identifying the cause. Its final report blamed everything possible—including operators and fallen trees—except deregulation.

But the Congress mandated that the Department produce a report, the National Electric Transmission Congestion Study, which it released in August 2006. The report duly noted what everyone already knew—that areas of Critical Congestion included the New York City and Connecticut service areas, with Congestion Areas of Concern all the way from New York through Northern Virginia. The Los Angeles area was noted as a Critical Congestion area, with parts of the West Coast, from Seattle to San Diego, in the Areas of Concern category. But it is not in these regions that profit-conscious, and even foreign-owned companies, are proposing to build new power lines, or the new local generating plants that would obviate the need for long-distance transmission lines. Why?

Thanks to 30 years of irrational "environmentalist" brainwashing of sections of the U.S. population, particularly in "liberal" large urban regions such as New York and California, it is almost impossible to build new generating capacity—much less nuclear power plants—where the greatest needs are. Therefore, these regions, which do not generate enough power locally, are forced to import power from other utilities. Thanks to the efforts of the same so-called environmentalists, these cities have not even been able to build enough power lines to bring in the electricity from elsewhere.

TABLE 1

What's Wrong With This Picture? Capacity Additions by Energy Source

(Megawatts)

Energy Source	2005	2006	2007	2008	2009
Coal	573	450	2,064	1,879	8,122
Petroleum	432	441	186	—	8
Natural Gas	15,216	12,499	16,013	9,895	5,451
Dual Fired	4,916	1,924	5,236	2,649	1,860
Other Gases	159	—	340	580	—
Nuclear	—	—	—	—	—
Hydroelectric Conventional	32	8	3	4	—
Other Renewables	2,519	294	126	147	1
Pumped Storage	—	—	—	—	—
Other	—	—	—	—	—
Total	23,846	15,616	23,967	15,153	15,441

Electric Power Annual with data for 2004

Report Released: November 2005

Next Release Date: November 2006

Source: DOE.

Adding new electric generating capacity over the past 30 years, has been determined more by economic “free market” fads, than rational planning. For the past two decades, natural gas was the fuel source of choice, largely because it was cheaper than alternatives. Then, when natural gas prices tripled, utilities turned back to coal. No new nuclear power plants are listed for the next few years.

Under the no-holds-barred market of deregulation, this “elsewhere” has moved further and further away from the large cities, with their large power requirements, to areas of the country where power can be produced more cheaply, and new plants can be built with the minimum amount of local political opposition and legal interference.

For example, PJM is a regional transmission interconnection, which coordinates the operation of the transmission grid that now includes Delaware, Indiana, Illinois, Kentucky, Maryland, Michigan, New Jersey, North Carolina, Ohio, Pennsylvania, Tennessee, Virginia, West Virginia, and the District of Columbia. It oversees 56,070 miles of transmission lines, and plans regional transmission expansion to maintain grid reliability and relieve congestion.

In March, PJM identified transmission constraints in its region, which were standing in the way of “bringing resources to a broader market.” PJM identified two transmission paths requiring significant investment: a high-voltage line from the coal fields of West Virginia to Baltimore and Washington, D.C. and another, extending from West Virginia to Philadelphia, New Jersey, and Delaware. However, these lines, hundreds of miles long, would not be necessary, if the mandate existed to build new nuclear plants where the capacity would be near the load centers (**Table 1**).

While Virginia and Maryland utilities are considering such new builds, most of the nuclear power plants that are

under consideration by utilities are in the semi-rural Southeast, where there is political support for new plants, and building more high-voltage transmission lines to carry the power is unlikely to be held up for 15 years by “environmental” court challenges. Some of that new nuclear-generated power from the Southeast will be used locally, for growing demand, and some will be wheeled to the energy-short regions of the mid-Atlantic and Northeast, which refuse to build their own capacity. Companies that have been buying up transmission capacity will make a bundle, in the process.

Investment in new transmission capacity overall has left the grid system vulnerable to even small instabilities. The industry estimates that \$100 billion is needed in new transmission capacity and upgrades, as quickly as possible. The 2003 blackout did spur some increase in investment industry-wide, from \$3.5 billion per year to \$6 billion in 2006. But profit-minded companies are only willing to invest funds where there is a profit to be made, namely to carry their “economy transfers,” regardless of how that destabilizes the grid system overall.

In a July 2006 article, three former electric utility executives, who formed the organization, Power Engineers Supporting Truth (PEST), out of disgust with the refusal of the government to pinpoint deregulation as the cause of the massive grid failure, after the 2003 New York blackout, stated that the “core issue is an almost fundamentalist reliance on markets to solve even the most scientifically complex problems. . . [P]olicy makers continue to act as if some adjustment in market protocols is all that is required, and steadfastly refuse to acknowledge the accumulating mass of evidence that deregulation . . . is itself the problem. Social scientists call this kind of denial, cognitive dissonance.”

The engineers, who have among them, more than five decades of experience in the electrical utility industry, insist that “new transmission lines will not by themselves improve reliability. They may increase transfer capacities, and hence improve commercial use of the grid,” but will not necessarily improve performance of the system. “Reliability standards have already been reduced to accommodate greater use of the grid for commercial transactions,” they warned (**Figure 1**).

There has been a huge penalty for this disruption of the functioning of the electric grid. PEST estimates that the 2003 blackout incurred economic losses in excess of \$5 billion. The California blackouts cost in excess of \$1 billion each. The national impact of declining reliability and quality, they estimate, is in excess of \$50 billion.

FIGURE 1

Increase in Transmission Congestion Since Deregulation, 1997-2004

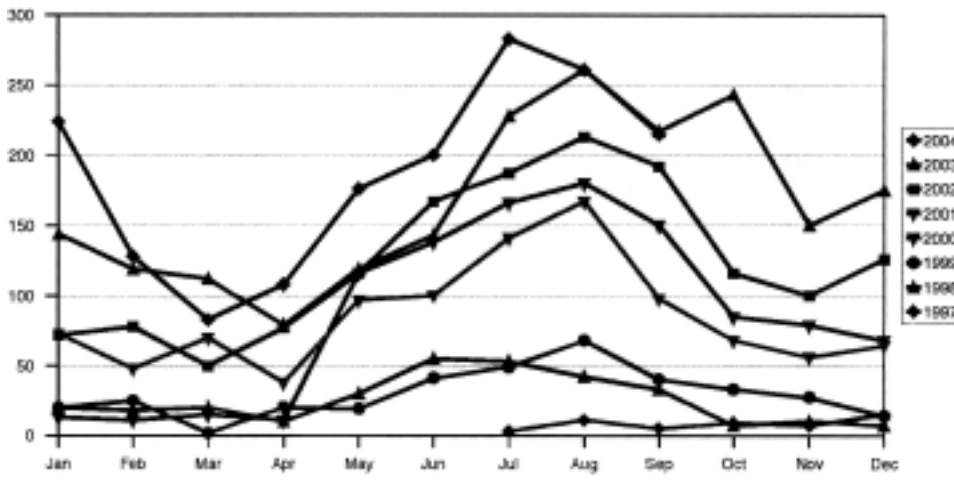

Since the opening of the transmission grid to “competition,” reports of instances of congestion have increased from a little more than 50 to nearly 300, during the peak Summer season. Level 2 Transmission Loading Relief Reports (shown here), which are given to the North American Electric Reliability Council, indicate that any further increases in transmission on a line would violate security limits, and any designation higher than Level 2 requires that transmission shipments be curtailed.

Source: NERC.

Where To Go From Here

When the California energy crisis of 2000-2001 was raging, distraught state legislators and the embattled Gov. Gray Davis searched for a solution. Although they knew what that solution was, they protested that it would be impossible to put the toothpaste of deregulation back in the tube. Lyndon LaRouche and *EIR* proposed that that was *exactly* what needed to be done.

On Monday, July 17, 2006, in the midst of an intense Summer heat wave, one of Con Edison’s 22 primary feeder lines failed, below the streets of the City of New York. Over the next several hours, five more feeder lines were lost. Voltage was reduced 8% to limit the instability, and the utility was faced with 25,000 customers—about 100,000 people—in the heat and dark. It took until midnight July 23—seven days later—to restore 20,000 of the affected customers, according to Con Edison.

The New York City blackout was the result not of a Summer heatwave, but of the decades of underinvestment in the infrastructure that distributes electric power from central feeder lines, through transformers, to the wires that deliver power to each home, school, factory, office building, small business, and hospital. Some of Con Edison’s underground infrastructure goes back almost as far as Thomas Edison’s first central generating station and underground cable, on Pearl Street in lower Manhattan, in 1882. It was a length of 59-year-old cable whose failure was a factor in the July blackout.

A couple of years ago in Philadelphia, workers for PECO Energy found that some underground utility cable still in service dated to 1899. In July 1999, the failure of outdated cable was blamed for power outages in Manhattan affecting

200,000 people. In San Francisco, a failed cable in December 2003 created an outage for 100,000 residents. “We’ve been using equipment far beyond its original intended life because we’ve been concerned with the cost of replacement and the need to keep utility rates down,” remarked Dean Oskvig, president of Black & Veatch, an engineering firm based in St. Louis, last month.

Industry-wide, there is agreement that weaknesses due to the age of the underground distribution cable have been exacerbated by the way the system is run in today’s deregulated world. To “save money,” the industry has turned to a policy of “run to failure,” where a company waits for a failure before replacing aged power lines and other equipment. Black & Veatch reports that although utilities currently spend more than \$18 billion on local distribution systems, most of that is to string new wire to new housing developments (which will likely come to an end soon, along with the housing boom), and that an additional \$8-10 billion per year is needed to replace obsolete and corroded equipment.

On top of this disinvestment policy, local distribution systems, like the transmission system, are being stretched beyond their design limits. In addition to chronological age, overheating of equipment that is caused by heavy electricity use and is repeatedly stressed will age faster, and is more likely to fail suddenly.

In 1986, Con Edison began a program to replace all of its older cable with a newer design. It is spending about \$25 million per year, and at that rate, the utility will not finish until 2024. By that time, some of its *replacement* cable will be 38 years old. Con Edison delivers electricity to 3.2 million customers, through 95,000 miles of underground cable, and 33,000 miles of overhead wires. Estimates are that about 27%

of its underground cable needs to be replaced. Why is it taking decades to replace old cable?

According to media reports, recently Southern California Edison sought approval from the state Public Utilities Commission to replace 800 miles of aging underground cable, after concluding that cable failures were the leading cause of outages that could be prevented. But “consumer advocates” opposed the utility’s request to recoup the \$145 million cost of replacement, on the grounds that the utility’s records were not adequate to ensure the worst cables would be replaced first. The utility will proceed and spend \$250 million more than is recouped in customers’ bills anyway, because they “don’t want to get too far behind.” Apparently the shareholder-driven “consumer advocates” never added up the economic, and sometimes, life-threatening costs, of the alternative—blackouts.

Before deregulation, companies like Con Edison would make investments in infrastructure that were deemed necessary, to maintain a level of service and reliability that met industry-wide standards, assured that state regulators would allow them to recover the costs, and maintain their financial health. Today, many states have no authority to either order investments or compensate companies that make them, leaving Wall Street and the “free market” to decide who shall have reliable electric power.

Between 1990 and the year 2000, utility employment in power generation dropped from 350,000 to 280,000, as utilities looked for ways to slash costs, to be “competitive.” Over the same decade, employment in transmission and distribution went from 196,000 to 156,000, in a system that is growing more complex by the day. Today, the average age of a power lineman is 50 years.

“Quick profit,” deregulation, shareholder values, environmentalism, have all run their course, and nearly taken down the electricity grid. It is time to change the axioms.

Transmitting Power, or Just Profits?

Yes, there need to be more power plants built, to make up for the deficits in electric-generating capacity in many parts of the country. It is also the case that entire regions, in particular the West and East Coasts, have so much congestion on their transmission lines, that they cannot import the power they need. And as seen in New York City this past July, breakdowns in 100-year-old underground local distribution systems are now leaving tens of thousands of people in the dark, and must be replaced.

But it is foolhardy to think that the needed investments will be made under the present regime. Today, thanks to deregulation, a company can earn more profits by *not building anything*, and instead charging more for what they already produce, by creating shortages. This strategy was implemented to perfection six years ago by Enron and other power pirates in California, which withheld power to raise prices through the roof, allowing them to steal tens of billions of

dollars out of the pockets of electricity consumers throughout the West Coast.

Today, unregulated utility companies do not plow a large portion of their profits back into improving infrastructure, but instead pay out higher dividends to stockholders. If even a regulated company has any hope of raising hundreds of millions of dollars on Wall Street to finance growth, it must prove itself creditworthy, by cutting costs and showing it can abide by shareholder values.

Individual companies no longer cooperate to ensure the overall reliability of the electric grid. They compete to build power plants and transmission lines based on their return on investment, not on the physical requirements of a regional system. They make themselves “competitive” to undercut the competition by cutting maintenance costs and getting rid of as many employees as they can.

For two decades, industry officials and NERC have warned that restructuring the electricity system would destroy it. An understanding of that danger provoked Dr. Anjan Bose, former Dean of Engineering at Washington State University, to comment, citing the advancement of power systems expertise in China and India that “the next time a grandstanding politician in North America compares our grid to that of the Third World, he may actually mean it as a compliment.”

There is no way to “fix” the system, as Congress has tried to do, by piling on more and more Federal regulations, to try to patch up the gaping holes in the broken system that now exists. The only remedy is to return the intention of the industry to one of providing universally reliable service, by putting the toothpaste of deregulation back in the tube.

The nearly two dozen states that have restructured their local industry, forcing utilities to sell their generation assets to conglomerate holding companies, in order to “compete,” must return responsibility and oversight for electric generation and distribution to the state utility commissions. These public servants should decide what should be built, and where, on the basis of providing for the general welfare, not the profit profiles of companies headquartered a half-continent away.

The now-congested and unstable long-distance high-voltage transmission systems that criss-cross the nation must be used for the purpose for which they were intended: to enable bulk power transfer in case of emergency, not to wheel power from one end of the country to the other so a company can import cheaper power, charge a few cents less, and beat out the competition. Responsibility for the transmission system should be taken out of the hands of the Federal deregulators, and returned to the regional reliability councils that formulated the rules of the road to keep the system robust.

There are no shortcuts. Decisive action is needed to reverse the past thirty years of failed policies.

Drive Your Car and Starve! U.S. Corn Belt Shifts to Ethanol

by Marcia Merry Baker

There are drastic agriculture shifts associated with the rising biofuels bubble, in particular corn for ethanol, as the accompanying figures show. The gasoline used by one SUV with a 25-gallon tank, for one year, is equivalent to the grain needed to sustain one person for one year, estimates Lester Brown, the founder and spokesman for Worldwatch Institute. Not to worry, says this green globalist outfit, based in Washington, D.C. Brown recommends that we radically reduce population and switch to low-tech wind power! Although Brown is dead wrong on the “solution,” it is true that there is a food-fuel tradeoff.

As of the 2006 current crop year, the volume of U.S. corn going into ethanol is expected to be 20% of the entire corn harvest, the largest percentage ever. Before 2000, it was less than 3%. Next year, it might rise to more than 25% of total annual corn production, according to Keith Collins, chief economist of the U.S. Department of Agriculture.

This corn flow is feeding some 101 ethanol bio-refineries now in production. The locations are shown in **Figure 1**, which also shows 42 more refineries under construction. In

addition, there are another 60 in the talking stage.

These distilleries are concentrated in the Corn Belt counties, shown in **Figure 2**. At the center of it all is Iowa, the nation’s top corn growing state. If and when all 55 bio-refineries now planned or operating are up and running, the *entire annual corn crop of Iowa could be utilized for ethanol*, instead of for livestock feed or food, according to the calculations of Iowa State University economist Bob Wisner.

The immediate effect of such a tradeoff of ethanol for fuel, not food, is that U.S. exports must be cut, according to forecasts by the U.S. Department of Agriculture. **Figure 3**, the “USDA Baseline Projections to 2015,” shows that corn for fuel ethanol will grow consistently, whereas other uses of corn will not. Corn exports are likewise depicted as stable or rising, but since this forecast was done in April, USDA economist Collins has altered the projection to say exports will fall.

Collins gave this news to the U.S. Senate on Sept. 6, at a hearing on renewable fuels. Collins also said that Brazil and Argentina should be expected to take the place of the United

States as the source of corn exports. This is a wildly offhand statement, given that U.S. corn exports account for 60 to 70% of the total volume of corn traded worldwide each year. At present, about 20% of the U.S. corn crop is exported. The largest importers of U.S. corn are Japan, South Korea, and Mexico, but many other countries also rely on U.S. supplies, including Russia. Under the North American Free Trade Agreement (NAFTA), Mexico was ordered, in effect, by global cartel interests to become dependent on U.S.-produced corn. Now, the order is to “shop elsewhere.”

Moreover, there are rumors that the U.S. boom in ethanol distilleries will suck in feedstocks from abroad, such as raw sugar

FIGURE 1
U.S. Ethanol Biorefinery Locations



FIGURE 2
U.S. Corn Belt

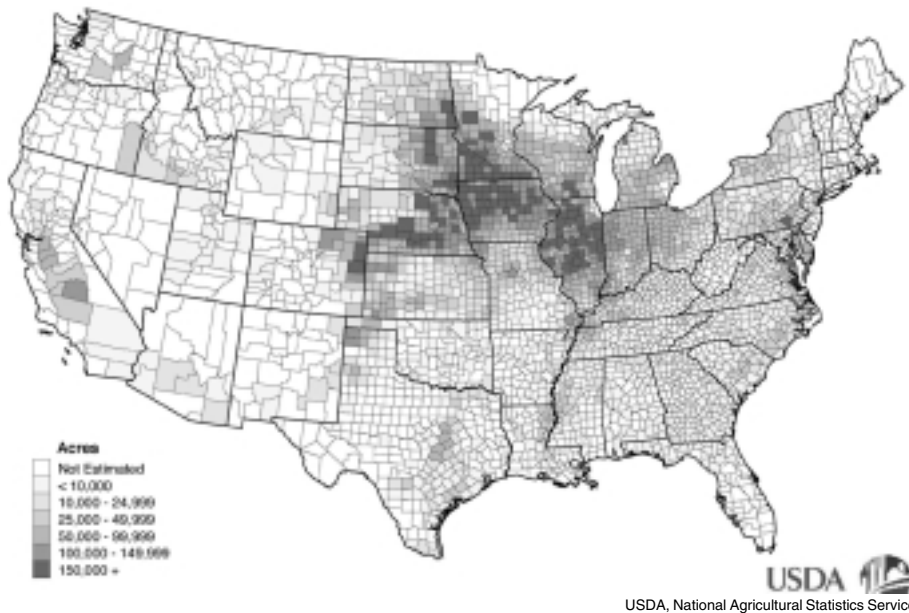
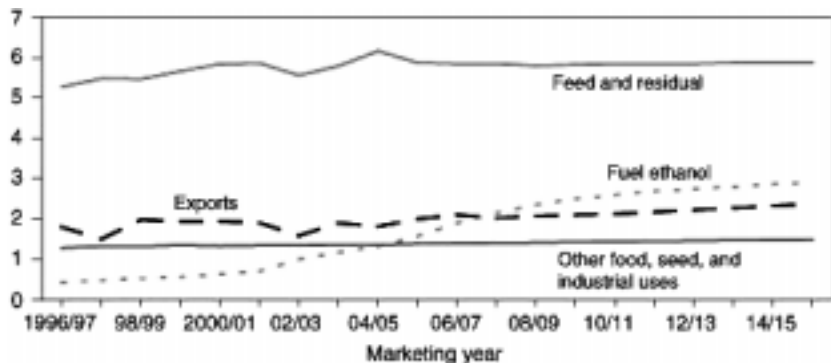

FIGURE 3
USDA's Baseline Projections Suggest That Corn Use by Ethanol Producers Will Grow Much Faster Than Corn Use by Other Industries



USDA Agricultural Baseline Projections to 2015

from the Caribbean.

There are other trade-off situations at key links in the food chain around the globe, for example, in Malaysia. Under free trade, Southeast Asian this nation has become the leading export source for palm oil, as well as relying on it heavily for domestic consumption. But now, so much palm oil is lined up for bio-diesel production, most intended for marketing in Europe, that there is a trade-off of palm land for production for food consumption. There are 52 new palm oil refineries under discussion for Malaysia. The leader of the pack is Cargill Palm Products Sdn Bhd.

In the U.S., the USDA “value-free” scenario for meeting feedstocks for biofuels, according to Collins’ report to the Senate, is that, although corn yields may go up a bit, more U.S. land needs to be cropped for ethanol. Corn acreage could rise to “90 million acres in 2010 . . . nearly 10 million more than the average planted during 2005 and 2006,” Collins said. He proposed that farmers could start corn growing on land now in the Conservation Reserve Program (CRP), which was set up to nominally protect the environment (by not growing row crops). The USDA has done a study to estimate that “4.3 to 7.2 million acres currently enrolled in the CRP could be used to grow corn or soybeans in a sustainable way,” he said. Furthermore, Collins pointed out that, as corn commands higher prices because of pressure from ethanol use, then “land must be bid into corn production and away from other crops.” Thus, more shifts in the food chain.

Biodiesel production, reliant mostly on soybeans or other oil crops, involves the same fuel-food trade-off dynamic. About 76 biodiesel plants are operating commercially in the United States, along with dozens around the world, and dozens more under discussion. U.S. production in 2005 was 75 million gallons, which seems like nothing in the context of 140 billion gallons of gasoline consumed per year, but the rate of growth in output—it tripled from 2004 to 2005—is “phenomenal, almost frightening,” in the words of the CEO of the National Biodiesel Board, Joe Jobe.

And the financial stampede is also huge, as it is with ethanol. Cargill and ADM are investing heavily into biodiesel, as are Chevron and BP. Vulcan Capital, led by Paul G. Allen, the co-founder of Microsoft, put \$10 million into Seattle Biodiesel, which recently changed its name to Imperium Renewables. The company now produces only 10 million gallons a year, but is building a refinery in Grays Harbor, Washington, to be able to produce 100 million gallons a year. Imperium now procures soybeans from the Midwest, but intends to command local sources soon. Once again, food crops are to be displaced.

One Year After Katrina, Huge Rebuilding Task Remains

by Mary Jane Freeman

One year after the worst natural disaster in the nation's history struck the Gulf Coast, the monumental task of rebuilding the lives, communities, and economies demolished by Hurricane Katrina still remains. The hardest hit states—Louisiana, Mississippi, and Alabama—had high rates of poverty and underdevelopment, especially of basic infrastructure, before the storm, and Katrina's path of destruction only made conditions much worse. It is now for us, the living, to launch the "biggest rebuilding effort the world has ever seen," a vow President Bush made on Sept. 15, 2005, but has failed to keep.

Standing today in Waveland or Bay St. Louis, Mississippi, you would see a "war zone," one area elected official told *EIR*. Yet, Mississippi officials of various state agencies

report that schools and hospitals are open and road repairs are well under way. Another elected official from the region, aghast at this state official's picture, retorted that schools are open "in trailers" and hospitals are barely open. "We don't have a trauma center down here at all; we've lost 75-80% of our homes; and our hospital is back at 25% capacity. Anybody who gets seriously injured here has to be airlifted to either Ocean Springs, Mobile, or Jackson" hospitals, he said.

The wreckage across the 90,000 square miles of Alabama, Mississippi, and Louisiana is massive. The St. Louis Bay bridge—obliterated by the storm—**Figure 1**, connected the cities of Bay St. Louis and Pass Christian, Mississippi. It won't be replaced until May 2007 with two lanes, and November 2007 with four lanes. Thousands of motorists now take detours and fight traffic to get to their destinations. Several other bridges were wiped out and hundreds more were severely damaged across the region. Nearly 500,000 homes were destroyed or damaged, with the highest percentages of loss in Louisiana and Mississippi, **Table 1**.

As Lyndon LaRouche charged a year ago in an Aug. 31 press release, "Our 'Tsunami' Was Called Katrina!": Thirty years of destroying industries, farms, and basic infrastructure, and a zeal for cheap labor led to "third world-like conditions . . . proximate to the gambling paradises of Louisiana and other once-proud states. . . . These changes of the past three-odd decades, combined with a degree of negligence of the Bush-Cheney regime, is tantamount to gross, impeachable negligence. . . ."

New Orleans City Council president Oliver M. Thomas, Jr., speaking at a Washington, D.C., forum on Aug. 22, recounted the huge loss of life and infrastructure, and pointed to the axiomatic cause for the failed Federal action: "Some say the local community should

FIGURE 1

St. Louis Bay Bridge, in Mississippi After Hurricane Katrina Hit



Kansas Adjutant General, accesskansas.org

St. Louis Bay Bridge, obliterated by Hurricane Katrina, was the life-line between Bay St. Louis and Pass Christian, Mississippi. Now removed, two-lanes of a new bridge here will open in May 2007, and four-lanes by November 2007—two and a half years after the disaster.

TABLE 1

Catastrophic Housing Losses in Louisiana and Mississippi

Location	Owner-Occupied (%)	Renter-Occupied (%)	Total (%)
Louisiana	29%	35%	31%
Orleans Parish	76	67	71
St. Bernard Parish	75	97	81
Cameron Parish	84	127*	90
Jefferson Parish	50	58	53
St. Tammany Parish	71	68	70
Mississippi	21	22	21
Hancock County	82	121	90
Harrison County	62	78	68
Jackson County	61	73	64

*Some percentages are above 100% as the denominator used was the number of housing units in 2000, which may be lower than the number damaged in 2005.

Note: These FEMA loss estimates are cumulative for 2005 Hurricanes Katrina, Rita and Wilma.

Sources: *GulfGov Reports: One Year Later*, August 2006; Rockefeller Institute of Government and the Public Affairs Research Council of Louisiana; *EIR*.

be prepared to deal with it. Well, then, what is the Federal government there for? . . . Were we expected to have the resources, experts to deal with the worst disaster in U.S. history? Anybody who expected us to do that is not coherent, sane, or alive. It sounds good. It is not reality.”

Before Katrina struck, poverty rates in Mississippi, Louisiana, and Alabama ranked first, second and fifth, respectively, in the nation in 2005. By the U.S. official (but wildly understated) poverty rate, 20 counties in the three states had 30-45% of their people in poverty. Dozens more counties were ranked very poor, and only 10 counties had poverty rates less than 15% **Figure 2**. Disaster has compounded the plight imposed here.

Putting Profit First

The negligence and non-reality has been amplified by Bush's appointment of big-time contributor and close friend, Texas banker Donald Powell, as his recovery czar. Powell, insists, “If the heavy hand of government impedes the private sector's proven ability to speed the recovery, it will take longer and cost more.” A year later, the private sector—for example, Halliburton, Shaw Group, and Bechtel—has done quite well by the Bush-Cheney regime, raking in billions of dollars in lucrative contracts for debris removal and some basic rebuilding, while less than 18% of FEMA contracts have gone to residents of the region.

The overall unemployment rate for still-displaced evacuees was 22.2%, as of August 2006, according to the Bureau of Labor Statistics. If all evacuees, including those who have the same residence as in August 2005 are added in, then the

FIGURE 2

Hurricane Katrina Hit Three of Nation's Poorest States

(Official Poverty Rate, Non-Institutional Population, Percent: Louisiana, Mississippi, Alabama)

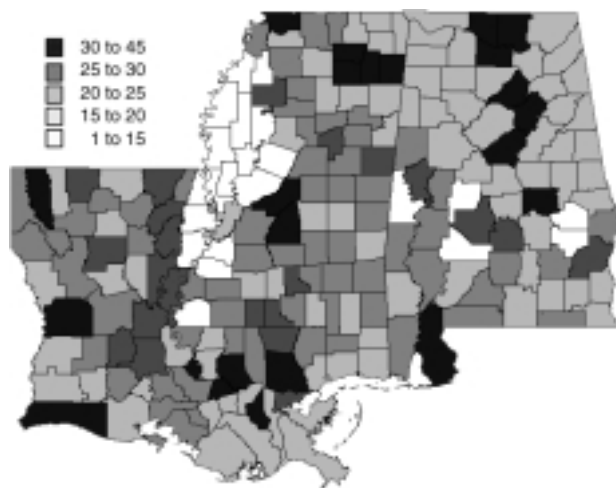

In terms of how far their populations are below the U.S. median income, the storm-hit states of Mississippi (2.9 million people) ranks first in the nation (30% below U.S. median income); Louisiana (4.5 million) ranks second (22%); and Alabama (4.6 million), fifth (18%).

rate is 12.6%, or almost three times the official national unemployment rate of 4.7%. As bad as these numbers are, the reality is worse, because even the Bureau of Labor Statistics warns that its sample data do *not* “include . . . people living in shelters, hotels, places of worship, or other units outside the scope” of its population survey.

Powell's rebuilding plans are dictated by his market ideology, not the promotion of the general welfare: Do the “markets” deem it wise to rebuild affordable public housing or hospitals in New Orleans? Or what will bring the highest rate of return on destroyed port properties—transportation infrastructure for trade, or gambling casinos?

Permanent housing needs for hundreds of thousands of people are in limbo. Sewerage and water systems remain compromised. Citizens, and state and local governments have to use their energies arguing with Federal agencies, such as FEMA, and insurance companies, over whether their losses are the result of the hurricane, and if so, how much such losses are worth. A Mississippi state representative told *EIR* that 18,000 people from his district applied for rebuilding grants, but as of Sept. 15, 2006, only 66 checks have been issued! The Bush-Powell rebuilding is a misnomer. An August 2006 Brookings Institution report, “Special Edition of the Katrina Index: A One-Year Review,” shows that of the \$109 billion in Federal funds allocated, and not all spent, more than 74% is for debris removal and temporary housing **Figure 3**.

FIGURE 3

Over 74% Federal Emergency Response Dollars Go to Clean-Up and Temporary Housing

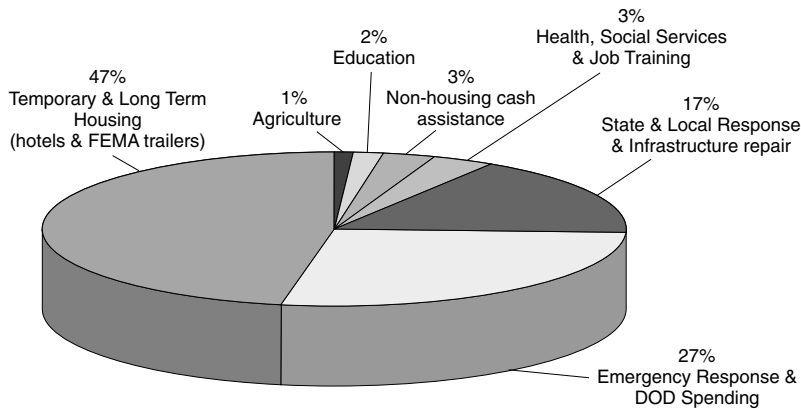

Note: These funds go to five states, Texas, Florida, Alabama, Mississippi, and Louisiana, impacted by hurricanes Katrina, Rita, and Wilma.

Source: Brookings Institution, *Special Edition of the Katrina Index: One-Year Review of Key Indicators of Recovery in Post-Storm New Orleans*; EIR.

The Job To Be Done: Build Infrastructure!

The conundrum is that without the underlying infrastructure—roads and bridges, sewer and water systems, schools, and hospitals—homes and businesses cannot be rebuilt, and people cannot return. “You need to fund your infrastructure first and then start building. You’ve got to do everything in tandem, but [Congress] doesn’t seem to get it,” remarked a representative of the Sewerage and Water Board of New Orleans (SWBNO).

Here is a glimpse of the huge job yet to be done:

- **Transportation.** Indicative of the infrastructure log-jam are the myriad complex problems in rebuilding the transportation grid. The Interstate 10 twin-span bridge, the key access in to New Orleans, which Katrina made impassable, is now patched together. To get building supplies into the city, this bridge is critical. Daily inspections of the patched-together bridge by engineers are required, as the increase of supply trucks puts unsustainable stress on it. Consequently, officials routinely close one bridge span four times a week for repairs!

This bridge and Mississippi’s St. Louis Bay bridge will be replaced, but completion is six to twelve months away.

Federal officials balk at covering costs for sub-surface damage to some key roads.

- **Water and Sewage.** The New Orleans water system of 1,600 miles of water mains, pumping stations, and fire hydrants sustained \$446 million of damage, the SWBNO now estimates. But FEMA will only pay \$113 million so far. FEMA deputy director for Gulf Coast recovery, Gil Jamieson, argues not only that the system is old, but too big for the reduced population of the city! So, Jamieson says, “How do

we not buy [the city] a completely new water and sewer system? . . . We want to give them what they deserve but . . . make sure they are not getting more than they deserve. . . .”

The system was old, needing \$640 million in repairs and upgrades before the storm. Because of litigation, the upgrades were under way. In 2005 there were 36 construction projects ongoing or completed and 24 design projects in full swing. But then Katrina struck, the levees failed, and the system was supersaturated for two months. SWBNO press spokesman Robert Johnson said, “The damage done to the system was so extensive that in order to maintain water pressure throughout the system,” we have to pump twice the demand. Some experts estimate that 85,000 gallons per day are being lost.

Mississippi’s Hancock and Harrison counties’ water systems likewise are in urgent need of restoration.

- **Flood control.** More than 220 miles of New Orleans’ key flood protection system,

the levees, were restored to pre-Katrina levels, but Congress authorized none of the needed improvements. The city lies below sea-level, as does most of the Netherlands where a nested series of advanced sea gates protects the country. The U.S. Army Corps of Engineers completed the repairs by August 2006 and is now to start to complete work—authorized in the early 1990s—to bring the levees up to a 100-year flood design level, which is not expected to be done until 2010! Clearly, for one of America’s oldest cities at the mouth of the nation’s crucial navigational waterway, the Mississippi River, Congress must authorize and fund an engineering feat comparable to the Netherlands’ system to protect our citizens and trade.

- **Ports and waterways.** Ports across the region sustained billions of dollars in damages, and they have relied heavily on private funds from their business partners and insurance money to repair critical infrastructure, bringing them back to 80-100% of pre-storm capacity. But support infrastructure, such as locks and dams on river systems into the ports, require Federal funds. A good example is the Inner Harbor Lock at the Port of New Orleans. Its replacement was authorized by Congress in 1956, yet it is not built! Some construction began in 1998, but Congress failed to sustain its funding.

Today, not having this lock, hampers 30% of the port’s terminals located on its Inner Harbor side. Until now, users on that side of the port used the Mississippi River Gulf Outlet, which had a 36-foot draft before Katrina. It is now silted in at 21 feet, preventing use by deep draft ships. The MRGO may be permanently shut, and at current build-out rates for the lock, it “will take another 5-10 years, assuming funds are

appropriated,” a port spokesman said. Completing the lock project obviates the need for the MRGO.

- **Agriculture.** Related to the ports are aquaculture and agriculture, both severely hit by Katrina. The Gulf of Mexico aquaculture value to the U.S. economy is about \$700 million a year. Storage and freezer facilities, marinas, and fueling stations at three major commercial fishing ports (New Orleans, Mobile, and Gulfport-Biloxi) had \$365 million in losses. Habitats, fishing grounds, and reefs had another \$104 million.

Destroyed boats number in the thousands. Half the number of shrimping boats in Mississippi are working this year as last. But the oyster harvest has been a disaster, down 50% because of beds lost. It wasn't until Aug. 25, 2006, that the Department of Commerce announced it would release a puny \$128 million for debris removal, and some seeding and rehabilitation in the beds.

Poultry and dairy farmers took big hits. Mississippi's poultry industry—the largest single agricultural industry in the state—was hammered twice by Katrina. First, Katrina completely destroyed 350 poultry houses and killed more than 7 million chickens. Then it destroyed the infrastructure at Gulfport, a key shipping point of bulk poultry to the world. Cold-storage facilities were wiped out, forcing the industry to send chickens far afield for shipping to Houston and Jacksonville, and tripling fuel costs. A year later, Gulfport is trying to rebuild its facilities with better cold storage warehouses and state-of-the-art blast freezers, but they await most of their insurance and FEMA settlements.

Dairy farmers lost entire herds of cows, the result of a combination of flooding, downed fences and barns, and road wash-outs that hampered rescue. Electricity loss was catastrophic, halting the necessary twice-a-day milking of dairy cows, and making it impossible to cool any milk that was produced. A year later, the dairy industry has not recovered. The quadruple whammy of Katrina, a multi-year drought, sky-high energy prices, and depressed milk prices have led perhaps 20% of the industry to fold up operations in Mississippi.

Fractured Schools and Health Care

U.S. Rep. James Clyburn (D-S.C.) speaking from New Orleans on a national conference call on Aug. 29, the anniversary

TABLE 2

One Year After Katrina, Half of Greater New Orleans Hospitals Are Open, Most Are Not at Full Capacity

Hospitals	7/1/2005		9/1/2005		1/1/2006		9/7/2006	
	Total	Acute/ER	Total	Acute/ER	Total	Acute/ER	Total	Acute/ER
Jefferson	15	6	3	3	10	6	14	6
Orleans	24	10	0	0	7	2	9	3
St. Bernard	2	1	0	0	0	0	0	0
Total	41	17	3	3	17	8	23	9

Staffed Hospital Beds	7/1/2005 All	9/1/2005 All	1/1/2006 All	9/7/2006 All
Jefferson	1725	644*	1535	1925
Orleans	2217	0	334	627
St. Bernard	138	0	0	0
Total	4080	644	1869	2552

*Primarily due to limited staffing.

Note: Elmwood Hospital, not included in totals, is a temporary replacement for LSU Charity Trauma Center.

Sources: Louisiana Hospital Association as reported by local hospitals; *EIR*.

sary of Katrina's landfall, stated: "There is very little rebuilding taking place. Insurance companies are still fighting over wind vs. water damage. . . ." He added that he had just completed a tour of Mississippi and New Orleans: "Schools are still closed, hospitals are . . . the one we went into yesterday is inside an old Lord & Taylor department store; everything is makeshift. People are afraid to come back home. Housing is not here."

- **Schools.** Mississippi's damaged schools are open, but "in trailers," as one legislator told *EIR*, recounting that two elementary schools in Hancock county were demolished as unsalvageable. Two more in Bay St. Louis will likely be razed. But, he said, to rebuild requires FEMA money and they won't give it unless the new schools are built away from flood zones, an impossibility in Bay St. Louis and Waveland, which are situated on the coast.

Primary schools in two New Orleans area parishes, Orleans and St. Bernard, barely exist. Before the storm, Orleans had 124 public schools serving 56,000 students with staffing of 7,500. As of July 2006, 25 schools serving 12,000 students were operating, most no longer as public but as charter schools. Although school officials hope to have 50 schools open by Fall, this means that 60% are yet to be opened. In St. Bernard Parish, where only 4 or 5 homes out of 26,000 survived, and only 10,000 to 20,000 people have returned to see if rebuilding is an option, school officials hoped to serve 3,000 students, one-third of last year's student body.

Twenty percent of Louisiana's public community col-



New Orleans' Charity Hospital, before Katrina struck. Adjoining it is the Tulane Health and Sciences Center of Tulane University. Today, only half of all hospitals in the city and surrounding counties are still open. Charity Hospital, which served the city's poor and uninsured, has been forced to relocate to a Lord & Taylor department store, because the hospital was so severely damaged.

leges, universities, and technical schools suffered between \$500-600 million in damages, affecting tens of thousands of students. Whether to rebuild, what to rebuild, and where to rebuild are questions intertwined with repopulation and enrollment numbers, which in turn are dependent upon people's ability to rebuild.

"The infrastructure problems are huge," said Dr. E. Joseph Savoie, Commissioner of Higher Education for Louisiana's Board of Regents. Of the 19 seriously hit campuses, some have been repaired, some are operating out of trailers, and a few are totally destroyed. "Housing is a very serious challenge for the resurrection of our public campuses," he noted, as 90% of the students were local residents. To date, very little of the Federal funding has gone to education. Securing a future for these schools and students will require not only monies for the physical infrastructure, but also for faculty, and aid for students to encourage their return to school.

- **Health care.** Health care is fragile across the stricken parts of Louisiana and Mississippi. A big problem is the level of uncompensated care which both physicians and hospitals are providing. Given the economic losses of individuals and communities, only Federal aid can solve this problem. Both Hancock and Harrison counties in Mississippi have lost most of their physicians and many nurses, thereby reducing the number of available staffed hospital beds.

The physical plant and equipment is at only 25% capacity in many damaged hospitals. Flood plain issues again will play a role in whether FEMA monies will aid rebuilding.

In New Orleans, roughly 3,000 nurses and 2,000 doctors have left the four parishes of Orleans, Jefferson, Plaquemines, and St. Bernard. As **Table 2** shows, only half of all hospitals—public and private combined—are now open in these parishes. (Plaquemines had no hospitals before the storm, so is not included.)

The Louisiana Hospital Association could not say at what capacity—quarter, half, or full—the open hospitals are operating. But note that of the 23 now open, only 9 provide basic acute or emergency care; the others are specialty hospitals. And of these 9, 6 are in the least affected parish of Jefferson. Without a return to pre-1970 full health-care standards, ensuring a full complex of high-technology hospital care in every county, Katrina's wrath will be

Bush's excuse to downsize health care there.

Out of Disaster, Opportunity

Out of disaster can come opportunity, out of which much good could come, were elected officials wise enough to seize it and launch a great infrastructure-building economic recovery of the Gulf Coast. Doing so, would simultaneously call the question on Congressional action to reverse the shutdown of the nation's auto sector; its skilled workforce and machine tool plants could be retooled to ensure mass production of component parts for such a rebuilding effort. Instead, Bush and Congress have dickered over dollars for the Gulf and refused to address the auto crisis.

Had the bipartisan initiative of U.S. Senators Judd Gregg (R-N.H.) and Ted Kennedy (D-Mass.)—encompassed in bill S. 1863, the Gulf Coast Recovery and Disaster Preparedness Act of 2005, designed to "rebuild and improve public infrastructure"—been enacted, it would have led to a plan and mobilization of national manpower and resources by of January 2006, with the rebuilding begun in earnest soon thereafter which, in turn, would necessitate the revival of the nation's manufacturing base.

Christine Craig researched the agriculture issues for this report.

China's 'Western Development' Spurs Growth of the Eurasian Land-Bridge

by William Jones

The Eurasian Land-Bridge conference, held in Beijing in 1996, with the participation of a Schiller Institute delegation headed by Helga Zepp-LaRouche (see *EIR Special Report*, "The Eurasian Land-Bridge: 'The New Silk Road'—Locomotive for worldwide economic development," January 1997) truly represented a far-sighted and optimistic vision for the development of the Eurasian land-mass and its peoples. Since then, the political and strategic situation has placed many obstacles in the way of development. The Bush Administration's series of local wars, from the Mediterranean region to Afghanistan, is setting in motion a conflagration throughout the entire area. Defense Secretary Donald Rumsfeld's attempt, backed by beastman Dick Cheney, to create a series of military "lily pad" bases in Central Asia, positioned to play a new "Great Game" with both China and Russia, has hampered, if not stopped, many of the more ambitious development projects in Central Asia. The development of the Eurasian transport grid has, nevertheless, proceeded apace. The latest meeting of the Shanghai Cooperation Organization (SCO) in Shanghai in June 2006, which placed the economic and energy issues at the forefront of the regional discussion, served to underline the strategic importance of the development of this rail/highway transportation project as the only real counterpole to the Cheney-Rumsfeld war policy.

A March 2006 article in the *China Quarterly* by Prof. John Garver of the Georgia Institute of Technology, a specialist in these issues, indicates the progress of the transportation grid. With the generous permission of Professor Garver, the following overview borrows heavily from his article.

Charting a Course Through Mountain and Desert

One of the main lines of East-West rail transportation from China to the West traverses Xinjiang, China's westernmost province, to Europe. The line crosses Kazakhstan at the Ala Pass and then proceeds to Aqtoghay in Kazakhstan. The Chinese portion of the line has recently been upgraded with double-tracking and electrification to alleviate the growing traffic. The Kazak portion of the line is also undergoing considerable improvement. From Aqtoghay, rail lines proceed further north into Russia, or southwest to Alma Aty and on to the Caspian Sea.

A second line from Xinjiang through Kazakhstan is

planned to cross the Kazak border further south and continue on to Alma Aty, the old Kazak capital, cutting the distance there by 350 miles. China's Ninth Five-year Plan (1996-2000) has also projected a third line from Xinjiang (the Southern Xinjiang Railway) which would extend from a line north of the Tarim desert basin to Kashgar. From Kashgar, two new lines are projected that would pass through Kyrgyzstan, which would link up to the Kyrgyz rail lines to Uzbekistan and Turkmenistan and thence to the Caspian Sea.

These new routes will also be facilitated by the construction of new railroad lines being built from the other direction by the European Union, under the aegis of the Transport Corridor Europe-Caucasus-Asia, TRACECA. The TRACECA line will usefully link up the five new Central Asian republics—Kazakhstan, Kyrgyzstan, Uzbekistan, Tajikistan, and Turkmenistan—and the three Caucasian republics, Georgia, Azerbaijan, and Armenia. Most of the roads and rail lines in Kazakhstan and Kyrgyzstan which will connect with Xinjiang are also TRACECA-supported projects.

These developments are complemented by a major upgrading of the Russian Trans-Siberian Railroad, that old workhorse of Eurasian rail travel. Under President Putin, the lines have been significantly improved, the double track electrified, and provided with modern computer communications. Every year, the freight has been increasing, with Chinese imports to Russia growing at a rapid rate. The Russian government also plans to increase its high-tech exports to China, thereby providing balance to what has largely been one-way traffic. The planned link-up of the Trans-Siberian with the Trans-Korea Rail line (see "New Silk Road Diplomacy Steps in Northeast Asia," by Kathy Wolfe, *EIR*, May 28, 2004) will increase this traffic, linking up other parts of Southeast Asia to the Eurasian grid.

Linking Up to South Asian Ports

Communications are also progressing to China's southwest. While the highway connection between Kashgar and Rawalpindi in Pakistan, the Karakorum Highway, is being significantly upgraded, there are still no concrete plans for linking these two cities by rail. The building of a modern highway along this stretch, once a part of the ancient Silk Road trade route, was initially undertaken by China in 1964 to link western China with northern Pakistan. China now is

Central Asia Rail Lines

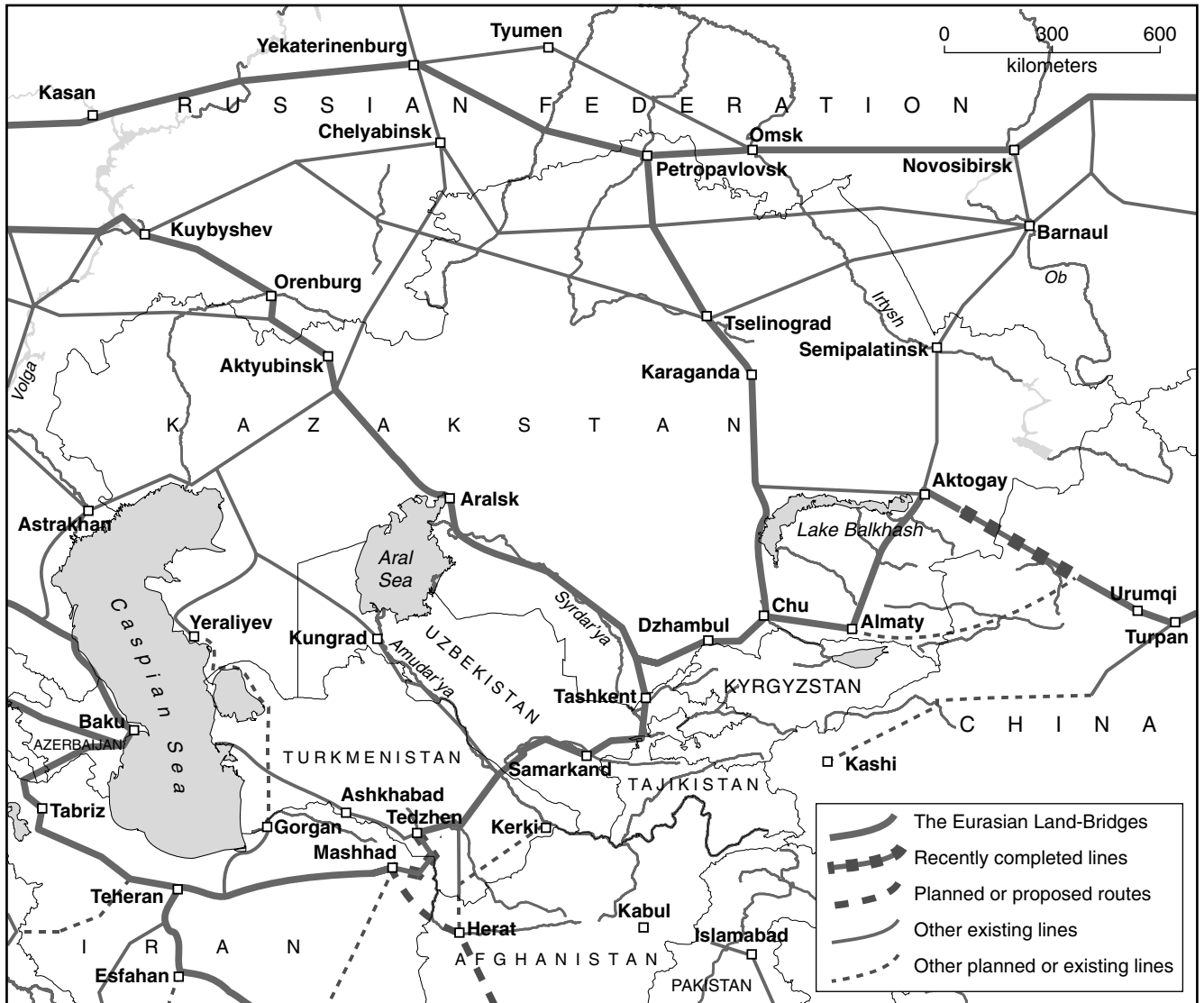

Source: EIRNS.

providing financial support for an improvement of the rail links further south, from Rawalpindi to Karachi. In addition, the Chinese intend to build a north-south rail link between an already existing east-west Pakistani line at Dalbandin to the coastal city of Gwad, which they intend to transform into a major deep-water port on the Arabian Sea, rivaling neighboring Karachi in the amount of transit cargo. At the groundbreaking in March 2002, Chinese Premier Wen Jiabao committed to support Phase II of the Gwadar project, which would deepen the new harbor to a depth of 154 meters, enabling it to receive 200,000-ton oil carriers and 100,000-ton container carriers. The planned Gwadar-Dalbandin line will also provide a link-up to the Iranian rail network.

China also assisted in completing the rail links between

Tejen in Turkmenistan and Mashhad in Iran, which will allow Chinese goods access to the Persian Gulf through Iran and to the Mediterranean through Turkey. Another China-assisted line was built between the Iranian cities of Baq and Zahadan, linking up the Pakistani and Iranian railroad network, providing access to the Iranian port of Bandar Abbas.

There are also moves now to upgrade the famous Burma Road connecting China through Myanmar (Burma) to the Bay of Bengal. The Ninth Five-Year Plan also envisioned the construction of a railroad, westward from Kunming, the capital of China's southern Yunnan Province, to the Chinese city of Dali, and beyond. The UN-backed project, the Trans-Asia Railway, also envisions the extension of the Kunming-Dali line all the way to Lashio in Burma, which would line



Lanzhou Railway Bureau

Construction of a railway bridge, on the Eurasian Land-Bridge in China. Although many obstacles have been placed in the way of the Land-Bridge's development, regional powers intend to realize its full potential.

up with the Mandalay-Yangon railroad. In addition, China is financing a new rail line from the capital of Yangon to Thilawa on the Andaman Sea, which is also earmarked for becoming a major port for goods transported by rail, as well as a seaport for the barge traffic coming down the Irrawaddy River, which already carries over 200,000 tons of goods from China annually.

Rails at the Top of the World

A recent centerpiece in the western development of China has been the completion of a rail link from Golmud in Qinghai Province to Lhasa, the capital of Tibet, which made its maiden voyage on July 1 of this year. Traversing the 1,956 km stretch over the Tibetan Plateau, the rail line has had to overcome some of the most difficult terrain in the world, with 960 km of the track located 4,000 meters above sea level. The largest stretch of track is built on stilts above the Tibetan plateau so as not to disturb the natural habitat, and contains some of the longest railroad tunneling ever constructed. A 1,686 meter-long tunnel in the permafrost region at an elevation of 15,092-15,748 feet had been pushed under the Kunlun mountain range. A 1,390 meter-long bridge had also been built across the Tuotuo River at an elevation of 15,092 feet. Some 550 kilometers of track is built on frozen tundra, and the average annual temperature on the Qinghai-Tibet line is 0° Celsius, with minimum temperatures of minus 45°C. Because of the rarefied atmosphere, the trains contain oxygen supplies which are provided to passengers as they need it. Chinese President Hu Jintao cut the ribbon at the Golmud Railway Station in Qinghai province. Both trains were fully booked with passengers eager to travel on the maiden voyage.

China also has plans to extend a rail line from Dali in southwestern Yunnan Province to Lhasa in far western Tibet. The railroad from Lhasa will also be extended to Yadong in the Tibetan prefecture of Xigaze. Yadong is only dozens of

kilometers away from a possible link to the Indian rail network, as well as to the rail network in Bangladesh.

China's construction of rail links through Tibet, as well as their involvement in the Myanmar rail network, has raised some concerns from Indian security circles, wary of the increased Chinese presence on the Indian Ocean. These fears have been deftly manipulated by the Cheney-Rumsfeld crowd, which hopes to bring India into its anti-China containment policy. While India has not been entirely immune to the interest shown them by the Bush Administration, it has consistently rejected being pulled into any conflict with China. On the contrary, relations between India and China have been steadily warming. The opening of the Nathu Lu Pass between China and India on July 5, 2006, an old Silk

Road route which had been closed for 40 years, indicates that India is fully aware of the benefits in the increased trade and transportation links with China. If China and India truly develop a close collaboration in the economic realm, this would also open the way for an extension of the Tibetan line to Nepal and Bhutan and to the Bangladesh railroad network.

The China-India relationship is key to the successful development of the Eurasian Land-Bridge. Every extension of these rail links has tremendous implications for the overall political environment in almost all areas of its construction. A failure to implement the Westphalian principle of providing for the "benefit of the other" in such projects, will leave them open to manipulation by those who wish to sabotage the economic development of Eurasia and transform the rail links from a means of cooperation into a bone of contention. Therefore, a resolution of the outstanding issues between China and India, as well as a stabilization of the India-Pakistan conflict, must be incorporated into any agreements on transportation links from China further into the Indian Subcontinent.

Judging from the latest SCO summit, at which non-member India and non-member Pakistan were both represented, it would appear that the regional powers have made their own intentions fairly clear. They intend to enhance their mutual cooperation in the development of this immense region in the Eurasian heartland, which is destined to become the productive center of the world economy. The primary task now is to prevent the lunatics of the Bush Administration's "War on Terror" from plunging the region into a new bloody conflagration, that will leave these plans in ruin. At the same time, unless the machine-tool capabilities of the developed sector are brought to bear to create what LaRouche has called "corridors of development"—building new cities and industries along the lines traversed by the railroads—the transportation grid will become a mere skeleton, still awaiting those muscles and sinews that would give life to the region.

Seattle LYM Conduct Between the Notes

by Wesley Irwin,
LaRouche Youth Movement

LaRouche Youth Movement (LYM) organizers attended the week-long Applied Superconductivity Conference in Seattle, Washington, Aug. 27-Sept. 1, to interject some scientific and economic reality, and to learn more about the amazing technology of superconductivity. We found an open response from hundreds of scientists, who need our help in keeping science alive. We happily discussed solutions to the breakdown of the U.S. science orientation, and the ongoing global economic breakdown.

Superconductivity is one of the most amazing scientific discoveries of the 20th Century. This still largely unexplained property causes certain materials, at very low temperatures, to lose all resistance to the flow of electricity, thus enabling a variety of new technological applications. Its development could revolutionize our use of electricity, enabling higher efficiencies than previously imagined were possible.

Discovered in 1911, by a Dutch physicist named H.K. Onnes, superconductivity was first demonstrated in cooled mercury metal. Through the 1900s, many other materials were found to be superconductors at temperatures below 23.2 kelvin. These materials are referred to as low-temperature superconductors (LTS), while those discovered decades later are known today as high-temperature superconductors (HTS), and are used at temperatures above 23.3K.

In 1986, J.G. Bednorz and K.A. Muller made an enormous breakthrough, discovering copper oxide-based ceramic materials that could be superconductors at temperatures as high as 35K. This was followed by another revolutionary discovery in 1997, by Dr. Paul Chu, who found a superconductor functioning above 77K (about 196° celsius), which is the boiling point of liquid nitrogen. (Dr. Chu was one of the scientists we talked with at the conference.) Since Chu's breakthrough, worldwide research has uncovered oxide-based superconductors with critical temperatures as high as 135K, which offer tremendous potential for improving the efficiency of electricity.

Transforming Electrical Transmission

Today's application of superconductivity technology is potentially all encompassing for the electric world. HTS

wires, for example, are capable of carrying currents that are more than 100 times higher than currents carried by conventional copper wires of the same dimensions. HTS power cables can transmit 3-5 times more power than conventional copper cable of equivalent cross section. Unlike oil-cooled electricity transformers, HTS transformers, cooled by liquid nitrogen, pose no fire risk, and are capable of operating at twice the overload capacity of conventional transformers. Some of these cutting-edge wire and cable technologies are already being successfully implemented in Albany and Long Island, New York, and in Columbus, Ohio.

In the transportation sector, HTS is being studied closely by the U.S. Navy, among others. In fact, in 2000, the U.S. Navy announced that it would eventually migrate toward an all-electric fleet! Electric propulsion systems more fully integrate a ship's total energy usage, and HTS motors and generators operate at one-third the size and weight of their conventional copper-wound predecessor, not to mention that they run more quietly.

Perhaps most exciting is the potential advancement of transportation systems through HTS application to magnetically levitated (maglev) trains, which, by utilizing superconducting magnets, are able to make trains safely "fly" above their tracks with zero rail friction; the opposing force of the giant HTS magnets causes the train to float. Magnetically levitated trains have thus far attained top speeds in excess of 500 kilometers per hour!

The scientific optimism associated with this amazing maglev technology was conveyed by the LYM organizers at the superconductivity conference, with the idea of building international maglev systems to transport physical goods, people, and cultures around the world.

Other applications of superconductivity have already made their mark. Medicine has been forever changed through the initial breakthroughs in HTS. Magnetic Resonance Imaging (MRI) requires HTS for the magnets needed for precision diagnostics imaging. Conventional magnets cannot provide the field values required for MRI, which relies entirely on a superconducting magnet.

In NMR (Nuclear Magnetic Resonance) spectroscopy science, LTS materials are being utilized to create progress in drug discovery, biotechnology, and genome and material science. NMR spectroscopy is even used in such areas as the determination of the chemical structure of extraterrestrial matter in meteorites, as well as the flow of matter in a variety of Earth materials.

In high-energy physics research, superconducting magnets are essential. The Relativistic Heavy Ion Collider (RHIC) at Brookhaven National Laboratory in New York, which smashes heavy ions together at very high energies, has two concentric rings which are made up of 1,740 superconducting magnets that contain over 1,600 miles of superconducting wire. The Fermi National Laboratory in Illinois has a similar device which accelerates protons and anti-protons to



EIRNS/Chris Jadzatz

Author Wes Irwin dips a banana into liquid nitrogen at a cryogenics display at the superconductivity conference. When hit with a hammer, the super-cold banana was smashed into pieces as if it were made of glass.

99.9999% of the speed of light (!), then smashes them together, to investigate what particles are produced.

Future Technologies

Most exciting may be the application of superconductivity science to nuclear fusion power, and space exploration, both subjects that LYM members have been researching, including tours of science facilities and special projects, to help push mankind off planet Earth, and into our natural role as gardeners of our Solar System, and even the outer regions of our galaxy.

One of the biggest scientific research projects in history, the International Thermonuclear Experimental Reactor (ITER) is the test model for what will become the first electricity-generating power station based on magnetic confinement of high-temperature plasma. This new fusion power device will require 1.8 million pounds of superconductors to help generate the high magnetic fields needed to confine and contain the high-temperature plasma, which reaches temperatures of 250,000,000° C—hotter than the Sun!

Superconductors are under development for a whole array of space-related applications, including magnetic actuators,

magnetic refrigeration, space-based magnetic plasma confinement, and even magnetically assisted propulsion. Just imagine a magnetic propulsion system on Earth capable of launching space shuttles into space, free of the burden of giant fuel containers. This would be ideal for continuous flights to Mars! All these potential developments are achievable in the near future—if the LaRouche movement succeeds in implementing a policy for science-driver economic cooperation across Eurasia, and then the rest of the world, in the coming period.

A Question of Political Will

The onrushing physical economic breakdown of the increasingly privatized infrastructure in the United States, has created a crisis situation: Old neglected power lines are catching fire, energy grids are susceptible to frequent shutdown, and entire cities are facing possible blackouts for hours, days, or even weeks, as power cables are pushed beyond their thermal limits. This brings us to the crossroads at which superconductor technology is not a mere “convenience,” but rather is one of a number of very real, life-or-death investment decisions for the U.S. Congress in its next session. Unfortunately, the Cheney/DeLay Republican-controlled Congress voted not to increase funding for superconductivity research, which is hovering currently at a mere \$35 million a year, a ridiculous amount for a research field that holds such promise for the physical economy, and which has produced five Nobel Prizes in physics.

Dr. Alan Lauder, the executive director of the Coalition for the Commercial Application of Superconductors (CCAS), which was a major sponsor of the Applied Superconductivity Conference, said the amount of money being put into research and development should be *doubled* out of immediate necessity alone. Lauder stated that if you take a look at a picture of what was running underneath the ground of major U.S. cities in 1906, and look underneath the exact same streets in pictures taken in 2002, the “failing infrastructure” of today is, “literally, the same as it was back then!” “The fashion of the men’s clothing changed in the picture, and that’s about it,” Lauder stated.

The director of the Oak Ridge National Lab’s Electricity Delivery Program, Robert Hawsey, stressed that superconductivity science needs government funding, because it is too big for the private sector to handle on its own. Hawsey said that if it weren’t for FDR’s Tennessee Valley Authority infrastructure program, which required a national political fight on economic policy, he wouldn’t be living and working in Tennessee today. The issue of increased funding in the field is completely political, he said.

Hawsey, who is also the head of the Renewable Energy Program at Oak Ridge, was adamant that the world has to move to massive nuclear power production. However, under current levels of funding, he said, the United States will be able to produce just a handful of nuclear plants over the next



EIRNS/Siri Martin

Seattle LYM members Chris Sandford, David Dobrodt, and Linda Vu in discussion with a superconductivity exhibitor (at right).

decade, at best.

In this discussion, and others, it became clear that although problems associated with the collapse of science infrastructure were widely recognized, there were little or no hypotheses being generated about the method of physical economic thinking needed to solve the crisis.

LaRouche Youth in Dialogue

LYM members Siri Martin and this author were able to have discussions with some of the world's most renowned scientists involved in superconductivity. What stood out to many of the scientists we spoke with, was that only a minuscule group of youth attended the event, and the level of scientific competence and interest we had in such a broad array of scientific fields.

Dr. Stephen Gourlay, the director of the Accelerator and Fusion Research Division at the Lawrence Berkeley National Laboratory, said that he, like many of his colleagues, know that there are not enough young scientists who want to work in these fields. Gourlay agreed that part of the problem in United States was the shift from a producer- to a consumer-oriented economy, that has taken place over the past four decades. He happily agreed to set up a tour for the LYM of the fusion research facility at Berkeley. We told him about the LYM work on Kepler's discovery of universal gravitation, and on Vernadsky's work on biogeochemistry, and Gourlay (like everyone else we talked to at the conference), said that to restore the scientific tradition of the United States, the shift must come from government. He joked ruefully about how the lack of funding (the fusion research budget is peanuts) means that we'll always be 30 years away from fusion power.

Victor Yarba, a Russian nuclear physicist working now at the Fermi Laboratory, who decades ago made three original breakthroughs in nuclear power research, was even more adamant about the role of the youth in the United States. "You're

the future! You're the ones who must do it!" he exclaimed. We told him about our work on rediscovering the discoveries of Mendeleev's Periodic Table and Vernadsky's conception of the Noösphere. He became very excited, but then expressed great sorrow at how the United States used to lead the world in science, but that now that tradition is almost dead.

Yarba has trained more than 200 other Russian scientists who are now working in the United States. He excitedly took all of our literature and wanted to stay in touch. In the science field, as with most everything else of real physical value, the United States is currently importing quite a lot, and producing very little.

The last day of the conference featured an "open to the public" session, and all the Seattle members of the LaRouche Youth Movement attended, having discussions with the superconductivity scientists, and playing with their experiments—the liquid nitrogen was especially fun. We were by far the largest group of young people there, and were very effective in engaging many of the scientists on the difference in method between Leibniz and Newton. We also intellectually fought with others over the Second Law of Thermodynamics, challenging these scientists on the self-evident reality of the Universe's anti-entropic, self-developing nature, which is an idea that flies in the face of all the teaching of modern physics textbooks.

A 'Solarian' Symphony

We distributed more than 100 copies of *21st Century Science & Technology* magazine. For many of us, the conference was a glimpse at what a culture based on discussion of beautiful scientific ideas could actually be like—a world in which current conceptions of reality are based not on immediate sense experiences, like those perceived by higher ape species, but rather on the scientific conception of what you want your life to have contributed to humanity's development, 50 years down the road from the time your biological existence ends. Because of the rigorous science and music curriculum pursued by the LaRouche Youth Movement, we were able to uplift the discussion in some cases to that more truly human level, by providing the overarching idea necessary for beautifying the composition of the conference itself.

The largest roadblock for the application of superconductor science today, comes from a Baby-Boomer-dominated Congress, and a highly intellectually challenged President, who both, in varying degrees, represent the thinking quality of the U.S. population. For those who claim ignorance of conceptions of physical economy, the LYM will be there to give scientists, Congressmen, and citizens, the needed pedagogical illustrations, through their own ongoing work on Kepler, Vernadsky, and Bach, to help compose a cultural symphony of undeniable joy and optimism that will radiate out for generations to come. In doing so, we may become the zero-resistance conductors of mankind's future solar symphony.

A CONCEPTUAL PROPOSAL FOR THE NDC

The Mexican Republic Requires a Renaissance

by the LaRouche Youth Movement in Mexico

The following document was prepared by the LaRouche Youth Movement (LYM) in Mexico for the National Democratic Convention (NDC) convoked by Andrés Manuel López Obrador for Mexico's Independence Day, Sept. 16, to discuss what comes next in the battle to save Mexico from its current path towards disintegration. The document, published as a beautiful 16-page pamphlet (available at www.wlym.com/~spanish), was translated into English by Gabriela Arroyo and Hector Antonio Rivas, Jr. from the LYM in the United States.

There has been no period in history in which a society was so conscious of the necessity of a change in the previous form of thinking, as in the Renaissance.

—*La Edad de la Fe (The Age of Faith)*,
Anne Fremantle

Let us not forget that you cannot put new wine in old bottles; the mentality of our people has now changed and that is most important, because when the mentality of the people changes, everything changes. . . .

—*Excerpt from Andrés Manuel López Obrador's response to the TRIFE ruling (Federal Electoral Tribunal) recognizing Felipe Calderón as President.*

On Aug. 15, 1971, the world completely changed. That was the date that the international economic-financial system shifted in a way that affected the whole world, with a variety of repercussions felt in every corner of the planet. Today these repercussions are reflected in many different ways, and Mexico is experiencing one of them.

After this change occurred, the word “economy” ceased

to have any referent in production and came to be conceived of simply as an issue of monetary profit. As a result, the entire world economic system based on free trade is now in the process of collapse, reflected in the speculative bubbles on the verge of explosion (like the real estate bubble), in financial derivatives, or the illegitimate debt of Third World nations. Humanity is now in a very dangerous period, such that if we do not change the beliefs that have governed us to date regarding those fundamental concepts with respect to man, we will plunge into a New Dark Age.

The fascist system known as globalization is controlled by the same Synarchist bankers that in the past created and financed Hitler, Mussolini, and Franco, and today seek to impose their lackey Felipe Calderón in Mexico to continue with this world policy of genocide, with more social austerity, and the so-called privatizations. For this reason, American physical economist Lyndon LaRouche has unleashed a worldwide fight, especially in the Democratic Party in the United States, to return to the tradition of Franklin D. Roosevelt and expel the Nazis from the government: the stupid and clinically insane George Bush, the sociopath Vice President Dick Cheney, and their controllers such as the banker Felix Rohatyn and the financier George Shultz, who are capable of creating a nuclear Third World War in the middle of a collapse of the international financial system. This is why it is *urgent* that they be removed from their positions.

But this change in economics and politics did not come about on its own. It also involved a social perspective, located in a theory called the “post-industrial society,” which argues that human beings no longer needed production of technologies; that we had already reached our limits in that area, and

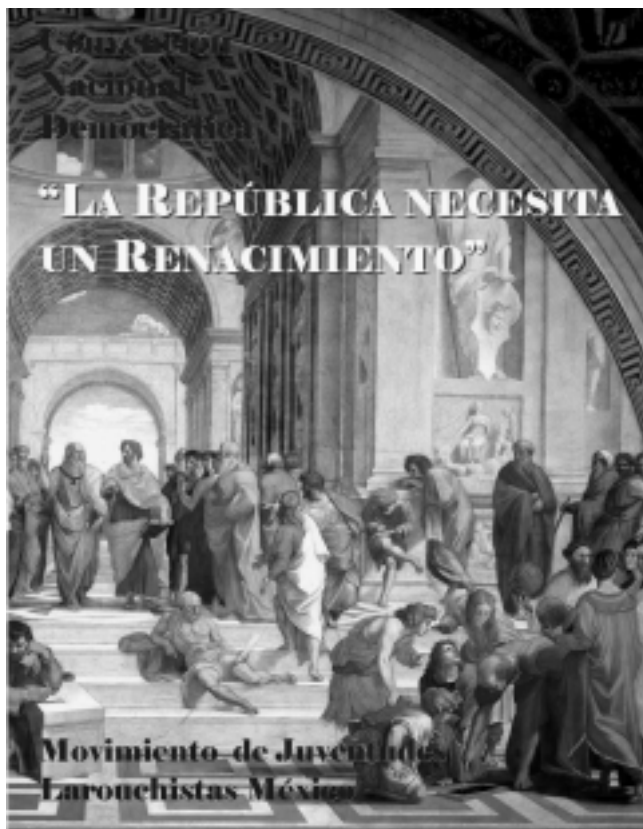

The cover of the new LaRouche Youth Movement pamphlet.



EIRNS/Stuart Lewis

Lyndon H. LaRouche, Jr.

This is explained more clearly in LaRouche’s “Triple Curve” of today’s collapse (**Figure 1**). You have exponential growth in the curve which represents financial aggregates (stockmarket, illegal debt, financial derivatives, etc.), tools used to obtain *profits* quickly—in themselves—without any direct reference to production.

The second curve represents merely monetary growth which, as can be observed, is insufficient for the level of looting done through financial aggregates. This level of looting is seen in the lower part of the graph, which refers to the capacity that the physical-economic process has to sustain a population. Last year, the Lower House of the Italian parliament, which approved LaRouche’s proposal for a New Bretton Woods, put out the official numbers: \$400 billion in financial aggregates versus \$41 billion of global GDP (gross domestic product).

All the money in the world together could not sustain the growth of these financial aggregates!

With this in mind, if we now talk about the real “national problem,” while at the same time failing to make changes at the international level, there will be few things, if any at all, that can be done internally. It is at this point that “the politicians of the old system” will say: “Don’t talk to me about the problems in the world. Tell me how to solve my *local* problem! Me, Me, Me!” This “me,” dear politician, is the same recurring mentality we mentioned above. But much more significant in our country is something called *Caciquismo*—the mentality which imprisons the *cacique*, as if in a fish bowl, so he cannot see the causes of the problems that reside outside

that we would have to now build a society in which *services* would be the primary referent. This insanity, which first started as a *social* theory, became an *economic* theory, and is what currently prevails.

The ’68er generation—also known as the Baby-Boomer generation in the United States—were the youth who were manipulated by the crises of that era: the assassination of moral leaders worldwide, the threat of nuclear war, the repression of political movements, etc. The psychological crisis thus created became the breeding ground for acceptance of these ideas, as absurd as they may have seemed. The so-called *social engineering* did its job.

The problem is reflected very well in the words of the stupid President of the United States, George W. Bush: Who cares what the next generation thinks of you, if you’re not going to be around anyway? This way of thinking of “*the here and now*” is the cornerstone of the current world crisis. Very simply, youth were induced to accept a culture of sophistry, without any idea of the future, and therefore without the necessary moral courage to fight for humanity. This is primarily seen in the upper 20% of the population. What mattered was to possess things—get as much as possible, as easily as possible, and the faster the better. Their mentality was just that. That is how they grew up, and today this is what we have as the generation which governs.

FIGURE 1

LaRouche's Typical Collapse Function

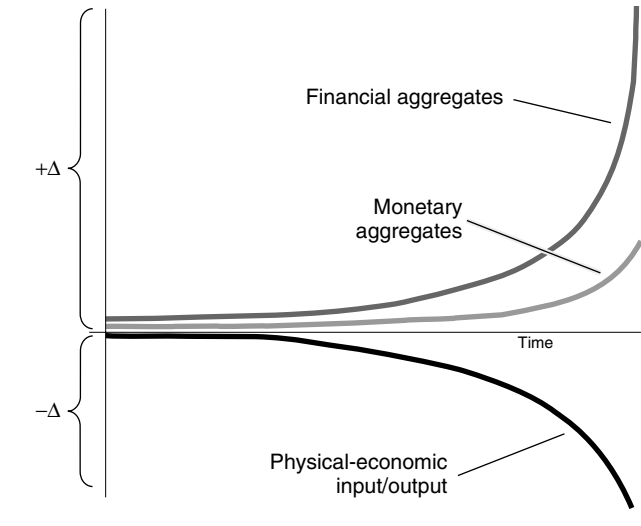

his *fiefdom*. This is just like the people who think that the crisis in Mexico has nothing to do with collapse of the world economy.

So, if we really want to solve the problems of our country, we are going to have to dump the old way of thinking—otherwise, we will never solve anything. LaRouche and his youth movement are spearheading the battle to mobilize the population and change the system. In the same way, we will have to combat that mentality which has brought us to accept this policy of the *ancien regime*. The youth of this generation, the so-called “no future generation,” are going to have to take leadership, not just to solve our own problems, but for future generations as well. The **LaRouche Youth Movement** assumes that leadership as its mission, not only as nationalists, but as what the poet Friedrich Schiller called “Citizens of the World.”

The objective of this document, presented in and for the National Democratic Convention, is to provide those conceptual elements needed to make a true change in our country—not only to restore our Republic, but to create a Renaissance in that which is its most important asset: its citizens.

A Repeat of the Occupation by Maximilian

During an international webcast Sept. 6 in Berlin, Germany, heard by audiences in that city, as well as in the United States, Russia, Belarus, Ukraine, Peru, Colombia, Argentina, Bolivia, Israel, and Iran, LaRouche commented on the Mexican Presidential crisis. In Mexico, the webcast was viewed in Sonora, Nuevo León, Guanajuato, Tamaulipas, Baja California Norte and in the Federal District (Mexico City), where it was transmitted directly to the LaRouche Youth Movement’s encampment in front of the Monument to Benito Juárez (President of Mexico, 1861-1863 and 1867-1872) which is part of

the permanent encampment established in the city by the non-violent resistance led by Andrés Manuel López Obrador.

To one of the questions from the Mexican encampment on how to enhance the revolution of conscience that ex-Presidential candidate López Obrador proposes, and how Mexico can undertake economic change and restructure the institutions in the sense that López Obrador is discussing, LaRouche responded:

“Part of the answer to this is often in what appears to be negatives. Look, the so-called Hispanic-origin minority in the United States is the largest single minority group in the United States, designated as such. It’s a mixture of people who have been in the U.S. for two or three generations, down to people who are illegal immigrants today. This is mixed with people from other parts of South and Central America, of course, but it’s the northern Mexico tier which is most heavily represented. Now, if there is not development in Mexico, and if the U.S. is going through an economic crisis, which would be a social crisis, then the conditions of the people on both sides of the border are such that you have an internal security risk within each nation, and across the borders. Absolutely uncontrollable risk. So anybody who is not going to do something about this, should be sent to prison, where they’ll have time to think about it, eh? Because we cannot tolerate this.

“Now, what’s happened—López Obrador has already said, and it’s valid, because I recognized the thing immediately, even before he said it. We just happened to collide in saying the same thing. What you have in Mexico today is a replication of the occupation of Mexico by the Emperor Maximilian. That is, the same kind of forces, the same forces which were imposed on Mexico by the combined British, French, Dutch, and Spanish fleet, and with the Austrian pig stuck on the throne; that is what is happening now with the case of Calderón. To stick a Maximilian on the throne of Mexico, while you have a Benito Juárez in the form of López Obrador, associated with the people—*this is an explosive situation for the entire hemisphere of the Americas*. And anybody who wants to force the Calderón dictatorship, which is what it’s supposed to be—whether that’s Calderón’s intention or not, I don’t know. You want to force that on Mexico? You’re going to blow up the hemisphere! And the hemisphere’s ready to blow!

“The key thing is, we’ve got to look at the fact of the matter. What can we do about this? Well, I say we have to get both Cheney and Bush out now. The grounds for doing so—look, Bush is clinically insane. He manifests that, it’s an open secret. It’s not even an open secret any more, it’s a sewer, it’s an open sewer. Cheney is a sociopath, who’s committed crimes. Why not just impeach the pair of them, and get rid of them? Send them back to Crawfish Ranch or something.

“We have to do it! You see, the times have come when you can not bargain and solve a problem within the terms that are given. You sometimes have to step outside the definition of the problem, and change the problem, rather than trying to solve the problem. In this case, if we can’t solve the problem,

then we're not willing to solve the problem, we can't mobilize it, we may have an absolutely hopeless situation! Civilizations have gone to Hell before, and this one can go to Hell too. We're on the edge of it. We're on the edge of it, if we don't do something about it. We've got to get Bush and Cheney out of there now! They should be impeached immediately. And any Democrat or Republican who won't do that, is an idiot."

The Role of the Nation-State in a Global Collapse

The objective of the fight within the history of mankind has been to *develop the happiness of the individual*, and this has required the creation of the best form of government which exists, which is the sovereign nation-state, with institutions which represent principles such as the Common Good, which encompasses ideas of economy, science, and culture for the development of the physical and creative well-being of the population, present and future.

In order to achieve a renaissance in our Republic, we require a profound comprehension of the nature of man, where the difference between man and animal is not defined as a biological issue, as if to be human means to simply be a union of molecules, and you would have to ask, "with what molecule am I speaking with right now?" The difference lies in the principle of cognition, which has allowed man to willfully increase his numbers by making discoveries of universal physical principles, applying them to the technological and artistic development of his society. Understanding developments in technologies is what permits us to increase the efficiency of the productive process in order to sustain a growing population.

Now that we see the degradation and danger in which the institutions find themselves because of the oligarchical system called "globalization," led by the Synarchist International which seeks to impose a policy of genocide through puppets such as Calderón in Mexico, there is a higher neces-

The Return of Operation Juárez

In 1865, President Benito Juárez and Mexico were living through their worst moments. The invading army had expelled Juárez from Mexico City. His army had suffered defeats in which they lost the most important cities to the French. The Hapsburg Emperor Maximilian urged Juárez to make a truce, and even offered him a position within the empire. Some of those who were allied with him begged him to accept; Juárez refused, and insisted upon the unconditional withdrawal of Maximilian from Mexico.

At that moment, in April 1865, Juárez wrote a letter to his family which began with a reference to the Civil War in the U.S.A.: "I praise and applaud Mr. Lincoln's inflexibility, for his victory will be all the more beneficial, though it come later, than an earlier peace won by sacrificing humanity." And he concluded: "There is no option but to continue the struggle with what we have, with whatever we can, and as far as we can."

It is understandable that Benito Juárez has always been the worst nightmare for the Synarchists in Mexico, especially in combination with Abraham Lincoln in the U.S.A.



Library of Congress
Benito Juárez

Juárez in 1982

In May 1982, Lyndon LaRouche visited Mexico and met with his friend, the then-President José López Portillo, who asked his visitor what the predatory bankers of Wall Street and others had in store for Mexico. LaRouche answered, that they have the intention of destroying Mexico with financial warfare by the end of the year; his forecast was borne out precisely.

At the request of a group of nationalists around the Mexican head of state, LaRouche published his report "Operation Juárez" in August 1982, in which he called for the formation of a debtors' club, to eliminate the illegitimate debts of South and Central America, and reorganize the legitimate debts in the form of long-term, low-interest-rate credit, in order to invest them in infrastructure and advanced technological projects.

As LaRouche explained recently: "That report was the manual guiding my part in the subsequent, August-October 1982 defense of Mexico, against the attack from specific alien forces. These were forces which were in fact descendants of the same Europe-based financier interest on whose behalf France's Napoleon III had deployed Hapsburg Maximilian's Nazi-like occupation and looting of Mexico. . . . Those French troops left under U.S. orders. . . . That U.S. order led to the downfall of the tyrant Maximilian, and made possible the restoration of the legitimate government of President Benito Juárez. Those were the historical circumstances of the 1860s which I adopted as precedent for the title of my August 1982 document "Operation Juárez" [www.wlym.com]. . . . That "Operation Juárez" report reflects the essentials of my continuing policy for the Americas today." (LaRouche, "My Unique Role in the Americas," June 30, 2003)

sity to fight for a new world economic system that recognizes the sovereignty of each nation, with governments and patriotic institutions which return to the interest of the people, as López Obrador is doing. Here we should look back to history and retrace the path taken by those personalities whose motivation was to leave behind a legacy for the continuous improvement of society.

The concept which emerged in the form of the modern sovereign nation-state was an axiomatic departure from imperial forms of governments, in which the concept of Truth does not exist, but rather the idea that each people is distinguished from another by so-called “popular opinion,” manipulated to accept and defend their slavery, just like those who defend free trade.

From this idea of nation arises the idea of national economy. As the German-American economist Friedrich List said: “The nation is the mediation between the individual and humanity.”

The LaRouche-Riemann Method in Physical Economy

The LaRouche-Riemann method improves in an essential way the American System of Political-Economy (which will be explained later). The fundamental discovery of Lyndon LaRouche is the functional relationship between technological progress, and growth of the economy and the population. LaRouche resolved this connection with the mathematical physics of Bernhard Riemann, treating economy as a multiply connected dynamic process (instead of the mechanistic view of statistics currently used by economists), where what defines economic growth are the technological leaps created by the application of new discoveries of physical principles in the universe. In that manner, the new economic stage is incommensurable with the previous one; that is, all the economic relations of production and social relations have changed.

The first distinction that must be recognized in the science of physical economy as established by its founder, the German scientist Gottfried Leibniz, is that human beings pursue happiness, and because of this, we are distinct from animals. Therefore, the growth of our economy, as well as that of our population, will depend on that difference, which permits us not only to utilize and distribute wealth, but also to generate it.

It is this wealth, generated by man, for which LaRouche has defined a physical metric capable of measuring the well-

being of the population, and not those diseased monetary parameters that have nothing to do with reality. This is what he calls **Potential Relative Population Density**. This function measures population density per square kilometer relative to a geographic zone (natural resources, fertile soil, climate, etc.) and the technologies created in a beautiful culture under the nation-state, at the same time creating the necessary potential for the generation of new technologies over the long term.

For example, how many people could we sustain on Earth without the technologies that we have discovered to date? We would probably not have developed beyond the few million who lived in those civilizations that only had fire as their means of generating energy, compared to the almost 7 billion human beings living on this planet today. Have you ever asked yourself why it is that rabbits, despite their reproductive capabilities, haven't increased their numbers into the billions? The answer doesn't lie in their sexual activities, but in the unique creative qualities found only in human beings, which permit us to discover and apply the principles which lie hidden in our universe, and to use them for the benefit and progress of humanity and the universe itself (see box “Dynamics vs. Energy”).

Vernadsky and the Infrastructure of the Nöosphere

One of the functions of the nation-state is to meet the physical necessities of its citizens, understanding this as infrastructure projects which guarantee transportation, energy, water, work, housing, health, education, etc. Let us focus on a national plan for agroindustrial development for the following two generations. This plan would take about 25 to 50 years, including amortization. Let us remember that we have two types of infrastructure, according to Russian biogeochemist Vladimir I. Vernadsky:

1. Maintenance of, and improvement in the way we help nature so that it can function and prosper in ways it would not have done otherwise without human intervention, such as: greening of desert areas, systems of irrigation, greenhouses, etc.
2. Artificial infrastructure, but as an integral part of the environment, essential to insure a certain standard of living and human progress.

This is the result of what Vernadsky called the Nöosphere (human cognition) as a geological force dominating living processes, in the same way that life, over many centuries, has been dominant over non-living processes. Vernadsky said that these are the three phase-spaces of which the universe is composed: the abiotic, the biosphere, and the nöosphere, where the difference between the abiotic and biotic is the principle of life, and the difference between the biotic and noetic is the principle of cognition. These principles, as economist Lyndon LaRouche has said, are invisible to our senses because they occupy the entire universe, which at the same time is self-bounded by these principles.



Bernhard Riemann

The action of mankind's noosphere manifests itself in the development of projects to construct new cities, highways, hydroelectric plants, development corridors, dams, nuclear power plants, magnetically levitated rail, etc. For example, there is the PHLINO and PLHIGON project, which consists of taking water from the South, where you have flooding, to the North, where the problem is a lack of water; and in this way, be able to create productive jobs (see Box "Dynamics and Energy"). We also need to build new cities in different states of the country where no technological development exists, and yet we could have a city equipped with what is necessary to maintain its population. In principle, it is to ensure that every citizen has the means necessary for his or her physical, emotional, moral, and intellectual development. That is how the future will become the measure of the present in the economy. We need to think of aerospace projects, research in plasma physics, fusion energy; in general, those

advancements which will permit us to continue to discover the laws of the universe, turning them to the benefit of our society.

Credit as the Flow of Development

All set! Now, if the mind is prepared to think in terms of physical economy, you might be thinking that these projects are possible, but that the famous "Don Dinero" ("Mr. Moneybags") isn't around to pay for them. But we can comfort ourselves with the knowledge that the economy is not money.

One of the characteristics of the sovereign nation-state is that there is a national bank owned by the state—not a private central bank—able to generate credit to finance whatever is necessary for its growth, and since we're talking about the population's wellbeing, it doesn't matter if it's something very expensive (monetarily), because the physical-economic advantages embedded in it are far greater.

We need to generate productive credit at interest rates of

Dynamics vs. Energy

Think for a moment about how to generate enough energy to move heavy industry (steel, petrochemicals, manufactures, etc.), supply the population (housing, offices, government buildings, trains, medical centers, etc.), and enough energy to have technologically advanced systems of agriculture that would free man from the slave labor of having to spend all his time producing them. The idea of creating efficient processes in less time and with higher rates of production, is what in physical economy we call *energy flux density*. Here, what matters is not the generated energy measured in calories, but rather how you generate it. That is to say, measure the intensity and density per unit area.

For example: The effect of repressing people by throwing buckets of water on them isn't really the same as directing a powerful water stream at them from the hose of a water truck! Or compare the power that hundreds of light-bulbs generate to the power concentration generated by a laser. That is why when we think of energy for the General Welfare, we have to think in terms of energy flux density.

Suppose that we have to generate our energy based on the use of: a) solar panels; b) windmills; c) biofuels; d) wood; e) petroleum; f) natural gas; g) nuclear material; h) hydrogen (in fusion reactors).

Let's answer the following questions:

1. What quantity of material in tons, would be necessary to produce that energy?
2. Where would such material be obtained?

3. What happens to the byproducts of these forms of energy production?
4. How many human beings can be sustained decently with that level of technology?
5. How much energy can be obtained per unit of mass (per kilogram)?
6. How are we developing new discoveries in the population (increase in creative capacity)?

Review the accompanying table and resolve your doubts.

If you have resolved the problem, you would have realized that the best is solar energy, but—Careful!—not in form of solar cells, but in nuclear reactors, either of processed plutonium or fusion.

So, if you still don't understand: Our future is the Sun!

Estimated Electrical Energy of Different Fuels

Fuels	KW/h per Kilograms of Fuel
Solar Panels	Have no constant generation; not quantifiable.
Wind Mills	Have no constant generation; not quantifiable.
Biomass	.75±.5
Wood	1.0
Charcoal	3.0
Petroleum Derivatives	4.0
Natural Gas	6.0
Natural Uranium	50,000.0
Enriched Uranium	250,000.0
Processed Uranium	3,500,000.0
Processed Plutonium	5,000,000.0
Hydrogen (Fusion)	Yet to be established

1 to 2%, through our National Bank, of course, so as not to depend on loans from the International Banking cults which have sacrificed millions of human lives every year to their god, *Don Dinero*. That is why the State has to take control of the banking system, to regulate it. Recall the actions taken by former President José López Portillo¹ in times of crises.

As you know, the major part of our banking system today is foreign-owned. This is a key aspect of the political fight waged by Lyndon LaRouche—to clean up the institutions as López Obrador recommends so they can return to the principle of the defense of the General Welfare. This credit is not inflationary, since it is backed by infrastructure projects that will pay for themselves through the jobs created, rather than by incurring unproductive debts or phantom investments that never contribute anything to society.

This is why we need a new economic system as proposed by Lyndon LaRouche—a New Bretton Woods with fixed exchange rates in which every nation can create sovereign credit.

The American System (Protectionism) vs. the British System (Free Trade)

Before we begin this outline of modern history, we need to stop thinking of history as a collection of horror stories narrated by a villainous nanny, who conditions her victim's mind not to recognize the real actors in real history. Because of the difficulties in founding a sovereign state in Europe outside the yoke of the traditional oligarchical systems, the Americas was chosen as the site for the founding of the first modern nation-state, based on the ideas of the Renaissance. Thus the first modern republic was consolidated as the United States of America, which won its independence from the British economic system, to then fight for and establish what only a few know as the *American System of Political Economy*.

The key figure of the American System was Alexander Hamilton (1757-1804), who served as Treasury Secretary from 1789 to 1795 under American President George Washington. Hamilton wrote three reports dealing with economic theory (see www.larouchepub.com): “Report on Public Credit” (1790); “Report on a National Bank” (1790); “Report on the Subject of Manufactures” (1791). Under Hamilton, the Bank of the United States—the first national bank of its kind

1. On Aug. 16, 1982, Mexico confronted bankers and international financial interests. President José López Portillo was faced with the choice of declaring a suspension of debt payments and nationalizing the banks, after financial authorities demanded that the oil price be lowered by \$10 and refused to buy oil in advance, to allow for payment of debts coming due. The decision was made to nationalize the banks and impose total exchange controls. The President stated, “. . . Therefore, to address the clash between public and private interests, there was no option but to make a nationalist effort of such radical characteristics as those we announced in September 1982, when we nationalized the banks and imposed exchange controls. There should be no standing with arms crossed, but imposing, as we did, exchange controls. It was that, or accepting the complete undermining of the power of the Nation.”

in the world—opened its doors on Dec. 12, 1791, based on the following principles:

- Hamilton refers to the Preamble of the U.S. Constitution, that obliges the Congress and the government to “defend the General Welfare.”
- A National Bank is required to increase national wealth, which promotes “the productive powers of labor” (agriculture, manufactures, infrastructure) with credit as a governmental institution.
- The capital base of the National Bank should not be limited to the existing volume of precious metals, but should include Treasury notes from the United States government. Thus, the issuance of credit can be extended as deemed appropriate to realize the economy's productive potential.
- The promotion of inventions and “mechanical improvements.” New plant and equipment are necessary for industry. This can be achieved through credit from the National Bank, state subsidies and contracts. These self-initiated improvements contribute to the expansion of manufactures and industry, thus creating new employment and ensuring the sale of domestic products in the internal market.
- Protectionist measures are legitimate and necessary against cheap foreign imports, to protect domestic production, which is still in the process of growth and is not capable of competing internationally. Nonetheless, protectionist tariffs should not delay the process of development, but rather should have a stimulating effect.

These measures allowed the United States to emerge from its grave crisis.

Next in developing this system was Mathew Carey, who met in France with Benjamin Franklin (1706-1790), where Carey was in exile because of Britain's occupation of Ireland. Later Carey travelled to the United States and met with Franklin again in Philadelphia. From that point on, Carey continued the tradition of Hamilton and polemicized against Adam Smith, calling him “the Oracle of Delphi of political economy.” Thus against Smith, Carey developed the following maxims of political economy:

- Industry is the only true foundation of virtue, happiness and greatness; and in all its useful forms and figures, it makes an imperious clamor for government protection.
- No nation has ever prospered without the protection of its domestic industry.
- Around the world, in all eras, wherever proper incentive for industry has been duly provided, humanity has been uniformly industrious.
- Whenever nations find themselves in a situation which violates these principles, it is imperative that their governments apply such remedies, to correct the evil as the nature of the situation may require.
- A free government is not happiness. It is only the means, when used wisely, through which, with certain resources, happiness is assured.
- The interest of agriculture, manufactures, and com-

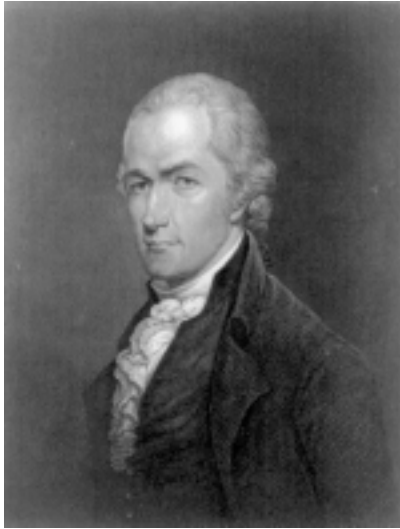

Library of Congress

Alexander Hamilton



Library of Congress

Henry Carey

ish: “The English national economy has as its objective to manufacture for all the world, and to monopolize all manufacturing power even at the expense of its own citizens’ lives, to keep the world, especially its own colonies, in a state of infancy and serfdom through political administration as well as the superiority of its capital, its ability and its navy. . . . The English national economy is *pre-dominant*; the American national economy only aspires to be *independent*.”

Adam Smith says that wealth is attained when each individual, pursuing his or her own interests, makes the nation prosper. Therefore, he argues, any attempt by the state to guarantee the prosperity of its people constitutes undue interference. List points to Smith’s primary maxim, *laissez faire, laissez*

passer (roughly, “let them do as they please”), and responds with, “a saying that is as pleasing to thieves, frauds, and robbers as it is to the merchant, is therefore very suspicious as a maxim.”

List elaborated three main components of his theory on productive aptitude: the capital of nature, the capital of productive material, and the capital of the mind, which he considered the most important. After 1830, List returned to Germany to apply the American System.

The American System had an abundance of defenders throughout the world, such as in Japan, China, Russia, France, Germany, Italy, Brazil, Argentina, Chile, Colombia, Peru, Mexico, and of course the U.S.A.

In Mexico, this protectionist current was represented by Estevan Antuñano (1792-1846), an industrialist and defender of the Republic. He believed that the only way to make the country independent was by promoting national infrastructure financed by the sovereign nation-state.

As a few excerpts of his writings reveal, he stated that, “*for our Republic the promotion of industry is not a mere calculation of convenience, but rather a point of honor and of independence.*”

Some of the policies he put forward are as follows:

- The absolute relaxation of laws regarding usurious loans, to put into productive circulation the large capital deposited in currency and jewels, that today are of no benefit either to their owners or the public wealth.
- The colonization of the coasts to increase consumption and tropical agriculture.
- Appreciation for and remuneration of those who correctly and consistently dedicate themselves to and excel in discoveries and promotion of industry, to awaken interest in productive and noble endeavors.

Another follower of this economic model was Carlos Ola-

merce are inseparably connected, such that were any of them to suffer any harm, the others would be materially affected.

Following the family tradition, the son of Mathew Carey, Henry Carey (1793-1879), also represented the tradition of the American System, which became a policy of the state when Abraham Lincoln was elected President of the United States. Together, they developed a policy of industrialization which contained the following elements:

- The regulation of private banking and the issuance of cheap credit and an abundant national currency, to protect the national economy from the predatory practices of private financiers.
- High tariffs to protect growing industry and reduce imports of products made by cheap labor.
- Government subsidies to extend the national railroad network.
- Public schools and free university education, free land for agricultural production for farmers, and government promotion of agricultural and technological knowledge.
- This idea of national sovereignty should be recommended to all countries as the best way of attaining and guaranteeing true independence.

In 1826, Mathew Carey co-founded the Society for the Promotion of Manufactures and Mechanical Arts in Pennsylvania, an organization which German economist Friedrich List was introduced to by General Lafayette, the French hero of the American Revolution. List met with both Careys on various occasions, and it was through these meetings that List learned of Hamilton’s Reports.

In his correspondence from Reading, Pennsylvania in 1827, List stated that he would focus on “refuting the theory of Adam Smith and company, whose errors are not yet understood as clearly as they should be.” In that correspondence, List differentiates between the American System and the Brit-

guibel, and here we briefly summarize some of his points for a new economic program:

- Long-term, low-interest credit for the promotion of industry;
- Protective tariffs, not only for consumer products but also to promote the national production of machinery;
- Development of agriculture based on industrialization of the country;
- State investment for the building of industries necessary for development.

In this sweep of history, we have been able to prove that nations that have become great powers by basing themselves on the principle of the General Welfare, owe their development to the application of sovereign protectionism, which, while allowing internal growth, at the same time, promotes alliances with other nations based on the good neighbor policy.

As for the Br(u)tish System, we won't take time to discuss

it, for its inefficacy is proven with each passing day. But we will mention its main classical precursors: Adam Smith, David Ricardo, and Thomas Malthus, among others. What is worth mentioning is that the American System has been omitted from the university curriculum, while the British System has been discussed in both its forms: free-trade economics, and what has been falsely presented as its opposite, that is, so-called "Marxism."

It is worth pointing out that Karl Marx and Friedrich Engels knew the works of Friedrich List and Henry Carey, and wrote a 30-page diatribe against List. What upset Marx was that List rejected materialism, and like Hamilton, insisted that "mental capital" is the true source of wealth. Marx and Smith considered the human being to be a materialist without a soul, and that's why the Marxist system only functions according to the parameters of the British System. Marxist thought resigns itself to the idea that history must be treated as an affirmation of the victory of the British System.

PEDAGOGICAL 1

Fighting for a Better Country Is Not Logical

This is because the universe in which we live is not governed according to the laws of formal Aristotelian logic, where thought moves in only two directions, by thinking that the only way of getting from A to B is by a straight line: A—B.

However, as we can see in Pedagogical 2, in the case of the doubling of the area of a square, a straight line does not work to get from one point to another, since a linear action, upon doubling the length of the sides, generates a quadruple of the square, and not the double. If the Aristotelian postulate were true, the square of area 2 would not exist. However, it does exist.

The paradox here, is that when faced with this conclusive fact, where the incompetence of this method of thinking which does not get along very well with the simple universe is demonstrated, there will still be those who defend the teachings of Aristotle in school!

Within Aristotle and his followers' formal logical system of thought, no real change is possible, his conception of the nature of the physical universe being essentially static and negating the idea of dynamic *transformation*, upon which the method of hypothesis—vital for all scientific discovery and all Classical artistic composition—is

based. Under the mechanical vision of Aristotelian logic, we would have to resign ourselves to living in the following kind of world: a) legality is good; b) the election of Calderón is legal. . . . Therefore, the election of Calderón is good! The mistake seems to be clear in this case, but be careful! Let's examine our method of thinking, so it may not be the case that by thinking in an erroneous way, we end up working, without being aware of it, for our adversary.

It Can't Be Seen Nor Felt, But It Is Present

Consider this poem by Gutierre de Cetin (1520-1557), "Ojos claros, serenos" ("Eyes serene, so clear"):

Si de un dulce mirar sois alabados
¿Por qué, si me miráis, miráis airados?
Si cuanto mas piadosos,
Más bellos parecéis a aquel que os mira.
No me miréis con ira
Porque no parezcáis menos hermosos.
¡Ay, tormentos rabiosos!
Ya que asi me miráis,
Miradme al menos.

What is the poem about? Does the *idea* exist, the theme of which Cetina speaks, in any specific part of the poem? Poetry speaks of realities that are not objective (*Ideas*) by means which are not objective; that is to say, metaphors. Even when the elements employed are objective on paper, the words are nothing more than shadows of the realities they reference, and the written

In his recent document, “How the Liberals Tried to Turn Engels’ Monkey into a Man,” LaRouche states that cycles of history must be understood as the effect of the popularization of a flawed method, and requires human volition as the principle of change in order to get out of the crisis.

Let’s not assume that the economy is something mystical, controlled by “little green men” under the floorboards, where we, the individuals, are only spectators. Rather, it is the voluntary process of self-perfection of nations and its citizens to generate the means to guarantee the search for human happiness in each individual of our Republic.

Against a Tragedy on the Stage of History, A Classical Idea

The threat of a New Dark Age which we face today, has as its origin in the generalized violation of Classical principles of statecraft, in which each citizen should be educated before finishing his elementary education. To understand history, we

must recognize the interdependence of politics and economics with the Classical methods which underlie science and art, represented most clearly in Classical tragedy, but also found in other artistic manifestations.

In times like these, in which lying is the most prevalent behavior in society—the product of cultural decadence rooted in hostility to scientific thinking and denial of truth—it becomes necessary to ask: On what should we base true knowledge? Those seeking the progress of humanity towards a political ordering which more closely approximates the Platonic concepts of the Good, the Beautiful, and the Just, and observing the ease with which a society allows itself to be dragged into sorry forms of collective suicide, shall have to acknowledge that for the creation of a successful state, the notion of truth becomes necessary.

Real politics is a form of Classical art, practiced according to the principles which the great dramatists Shakespeare and Schiller expressed in forms of composition and execution of

word is a shadow of shadows. . . . Then, why do you have a clear idea of something which, “objectively” does not exist? This demonstrates that there exist indirect means to communicate *with certainty* mental objects from one mind to another, which are more efficient than any formal medium.

The Future Determines the Present

We cannot discuss the future without starting from the fact that music, according to the principles of Classical polyphony, does exist. The essential elements of musical development start from the fact that human beings naturally have four types of singing voices, with biologically determined qualities. These function under the same scientific principles which determine the tuning of musical notes, which principles were developed in large part by J.S. Bach in what became known as the “well-tempered system.” These elements generate *Polyphony*, which functions in the same way that a society should function, where each one of the independent voices moves in relation to the *whole*, but without sacrificing its liberty.

A universe in which great Classical music¹—for example, that of J.S. Bach—exists, cannot be a universe congruent with the Aristotelian reductionist method, but rather one congruent with the Platonic scientific vision, where the idea of science is not the boring



Joahnn Sebastian Bach

generalization of statistical data, nor is time conceived of as an one-directional line.

Consider the first two measures of the first chorus of J.S. Bach’s motet “Jesu, meine Freude” (see next page). The movement of the voices seems more like the end of an idea than the beginning. But, where does it come from? If it is the end of something, where is the beginning? Now, if we considered music to be a succession of sounds, at the end of measure 4 we have a simple chord of B major. At the beginning of the following measure we have a chord of C major. Both chords are perfectly normal if they are played in isolation. If we play them one after the other, although it is logical (A—B), we get something meaningless. But in the context of the composition, the C “chord” is one of great tension, a species of *dissonance* whose significance does not lie within itself but in the *whole*. We humans do not listen to music as a succession of chords, but as social dynamic processes determined by individual choices, and by the context social.

Now consider measures 17-19: the initial idea! The paradox is resolved: the beginning originates from the end! Thus, it is the future which governs the present, and the vision of how we want the lives of those who follow us to be, is what molds the actions we take today!

1. Through Classical music, we come to understand the Platonic ideas of the good, the beautiful, and the just. The modern form of Classical ideas are associated with the influence of the Renaissance, particularly those of Nicholas of Cusa and his followers. For Classical composers we refer to J.S. Bach and his followers, whose method is the product of the establishment of the well-tempered system of vocal polyphony, as is documented in *A Manual of Tuning and Registration*, by Lyndon H. LaRouche and his collaborators.

J.S. Bach, *Jesu, Meine Freude*, Opening Chorale

1 (7) 2 (8) 3 (9) 4 (10)

Soprano I & II
 } Je - su, mei - ne Freu - de, mei - nes Her - zens Wei - de,
 } ach wie lang, ach lan - ge ist dem Her - zen ban - ge

Alto
 } Je - su, mei - ne Freu - de, mei - nes Her - zens Wei - de,
 } ach wie lang, ach lan - ge ist dem Her - zen ban - ge

Tenor
 } Je - su, mei - ne Freu - de, mei - nes Her - zens Wei - de,
 } ach wie lang, ach lan - ge ist dem Her - zen ban - ge

Bass
 } Je - su, mei - ne Freu - de, mei - nes Her - zens Wei - de,
 } ach wie lang, ach lan - ge ist dem Her - zen ban - ge

5 (11) 6 (12) 13 14 15

S.
 Je - su, mei - ne Zier, } Got - tes Lamm, mein Bräu - ti - gam, au - ßer dir soll
 und ver - langt nach dir! }

A.
 Je - su, mei - ne Zier, } Got - tes Lamm, mein Bräu - ti - gam, au - ßer dir soll -
 und ver - langt nach dir! }

T.
 Je - su, mei - ne Zier, } Got - tes Lamm, mein Bräu - ti - gam, au - ßer dir soll
 und ver - langt nach dir! }

B.
 Je - su, mei - ne Zier, } Got - tes Lamm, mein Bräu - ti - gam, au - ßer dir soll -
 und ver - langt nach dir! }

octave

16 17 18 19

S.
 mir auf Er - - den nichts sonst Lie - bers wer - - den.

A.
 mir auf Er - - den nichts sonst Lie - bers wer - - den.

T.
 mir auf Er - - den nichts sonst Lie - bers wer - - den.

B.
 mir auf Er - - den nichts sonst Lie - bers wer - - den.



EIRNS

LYM organizers read Cervantes' novel Don Quixote at Mexico City's Zócalo plaza, at the encampment of supporters of López Obrador.

poetry and Classical tragedies. To the argument that art has nothing to do with politics, as the former is an instrument of “entertainment and recreation of the masses,” and the latter “objective activity, and organization of society,” we offer a couple of historical examples to support our statements.

Abraham Lincoln won a complicated war with the help of lessons learned from Shakespeare, which he presented as guidelines to members of his Cabinet. On the other side, the Nazis, prohibited the performances of Friedrich Schiller's plays *Don Carlos* and *Wilhelm Tell*, as they (correctly) considered them a call to overthrow the tyrants.

Politics bereft of beauty reflects a bestial conception of man, where the creation of a society does not rest on the uniquely human quality which renders man superior to the beasts, and gives him the ability to transform himself, a quality shared with the Creator. In this latter point resides the necessity of Classical art, possessing that quality of transmitting truthful principles that it shares with science, in the task of bringing society to the understanding of what the poet Percy Bysshe Shelley called: “profound and impassioned conceptions respecting man and nature.”

Contrary to the bestialization to which current “entertainment of the masses” leads, the Classical artistic principles are based on the highest levels of deliberation in the creation of national policies, following the model of Plato's Dialogues, these being dramas which represented real political figures of the time. Through the process of rediscovery of the Platonic dialogue, the citizen experiences that quality through which he becomes increasingly efficient in the rational selection of political decisions. Thus, all Classical artistic composition functions according to those principles of the Platonic method.

Drama has been one of the most influential forces, for good or evil, in the fate of a culture. Pagan Rome and its perverse mass entertainment in the Arena exemplifies this, as opposed to the more successful, powerful, and revolutionary form of drama which moved and inspired people, produced by the leading intellectual of the national liberation struggle of the Prussian reformers, Friedrich Schiller.

This principle resides in the identification of the protagonist's tragic failure to consciously and radically change the destiny of a population whose customs and popular institutions have brought it, as in our present case, to the edge of the abyss. The politician's worst mistake is his failure to break with flawed customs, that would prevent his nation's population and its posterity from plunging into a terrible calamity. This principle of Classical drama is not based on appeal to the senses, as are, for example, the cheap sen-

sationalism and unabashed irrationalism of certain currents that convert drama into a forum for insanity, before an evermore brainwashed public. Victimized by reigning degradation, this public has ended up accepting ever more degenerate “artistic forms.”

In contrast, the principle of Classical tragedy is the Socratic principle of Truth, that which the audience recognizes as the efficient factors (intangible to the senses) that give form to evolving developments.

To build an advanced society, it is crucial to distinguish between the type of artistic activity which creates citizens, those individuals who freely contribute to the development of the republic through their own intellectual transformation, and those types of entertainment which either do not reflect these qualities, or openly destroy all idea of a higher morality, all sense of historical responsibility, any notion of human nature coherent with that quality of creative thought—in short, any notion of the Sublime, a principle at the center of all Classical art, as the only thing which is “truly free.”

The role of art is to enoble man and create an environment of cultural optimism in the whole society. A society that recognizes these principles would never have accepted so-called “popular music,” which at best, is completely banal. While we cannot deny that there are cultural manifestations that spontaneously emerge from certain social groups, in which these groups have located a large part of their identity, we also cannot deny that these groups are the most regrettable victims of liberal politics hostile to progress and development. We thus expose the incongruence and hypocrisy of some groups, which, under cover of certain “sociological” or “anthropological” indigenist theories, ignore the moral imperative to provide justice for these people, who live in misery

and are the “object of erudite study” by those who, in theory, defend their rights. Yet these same sociologists and anthropologists appear unwilling to offer these populations the opportunity to exchange their unfortunate circumstances for justice and prosperity.

Therefore, any national project based on particularities resulting from lack of development *must be rejected*, as it excludes the principle of truthfulness discussed previously. This is not based on any course of literary criticism or classroom musical salons, or on any “sociological” or “anthropological” theory as such, but rather on undeniable reality. These traditional manifestations shouldn’t be proscribed, but must give way, thanks to development, to a higher notion of art which lies in the unique ability of the individual human mind to discover universal physical principles validated experimentally, through which the human mind is capable of producing a qualitatively conscious increase in “ecological potential” that positively affects the entirety of the human race. We derive from this notion that Classical art belongs to all mankind.

As for our absolute rejection of certain forms of bestiality, such as “popular music,” including some of the most degenerate forms, such as “rock” and “electronic music,” among others, it’s not that we refuse to accept the scientific proof of its validity that their followers might present. It’s that they themselves refuse to offer any proof that might make them legitimate. They instead base their fierce defense on a cult of personal taste, or on the arbitrariness of certain pseudo-sociological “laws,” obstinately refusing to submit their artistic conceptions to the test of fire of the Platonic principle of Truth, which through Socratic dialogue, clearly proves the essence—true or false—to which it is reduced.

Science and Art

By a valid discovery of a universal physical principle, we mean something we cannot touch with the senses, but rather an *idea* through which the power of man to survive is increased in a tangible way. This increase generates measurable effects, which are therefore real, but the efficient causes of those changes cannot be detected by the senses.

These principles of mental activity are the basis for preparing the individual’s mind to attain a quality of truthfulness which scientific knowledge shares with Classical art forms. This is indispensable for scientific progress, and to avoid the cultural flaws such as those visible in the world today. The source of authority of Classical art for statecraft and the creation of republics, is that it is the most appropriate means to adduce the relative truthfulness of ideas by which a nation chooses to carry about its business.

To summarize: A successful state is based on the determination of whether the artistic composition emerging from it satisfies the following essential requirements:

1. It must never depart from natural beauty (beautiful forms as they occur in nature), based on the harmonic negen-

PEDAGOGICAL 2

What Defines What We See?

The line is said to be a succession of points, and the definition of a point is that which has no volume, no area, and no length, as Euclid defines it. How is it, that without length or with a length of zero, the succession of points at a given moment becomes a line? And what’s more, how would you generate from this axiom a method for constructing a form capable of reproducing lines which are proportional to each other? You would have to understand where it truly comes from (**Figure 1**).

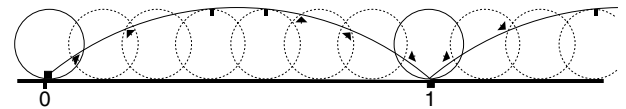
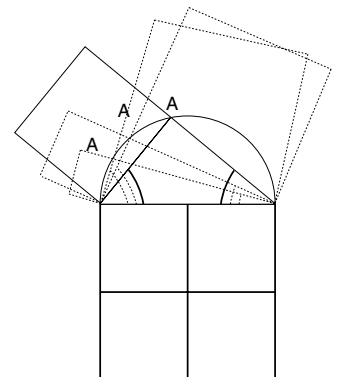

Figure 1 As the circle completes each full rotation, it defines the lines on the plane.

That’s how it is! It is only with circular action that you can obtain the way to determine whatever lines you want, but it does not simply end there. Let’s see what else the circle tells us when trying to go from a square of area 1 to a square whose area is 2 (**Figure 2**).

Figure 2 The squares above are smaller than the big one located below. Can you determine what is the relationship among these three squares as point A moves along the circumference? One of the squares grows while the other decreases, and vice versa. Discover the relationship between the proportion of angles alpha and beta at every instance of movement, and the proportion of the squares. Now determine at what point of the process you would have a square of area 1, of 2, and of 3 in relation to area 4 which does not change. Prove the hypothesis of whether the circle can define not only the lines, but also the areas (the squares).



If you were able to visualize the continuous proportional process of the squares along the circumference, you are now ready to continue, and make this idea yours, which

shall not be a difficult task if your commitment is to find real solutions to the crisis of our civilization.

In the previous challenge, it was easy to determine that the radius of the circumference generates the square of area 1 and the diameter of the square of area 4. The interesting thing is to find the proportions between these to find the areas we are looking for (2 and 3). (See **Figures 3 and 4.**)

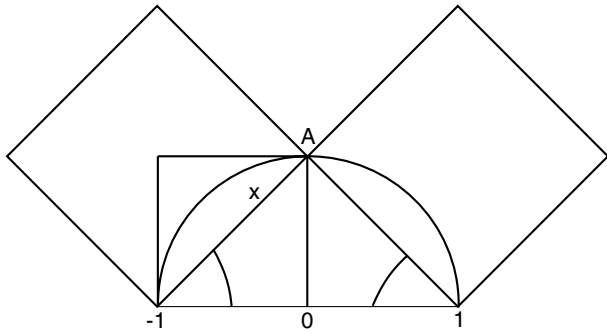
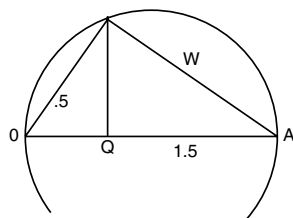

Figure 3 The radius of the length (1) is to the hypotenuse (x) as hypotenuse (x) is to diameter 2, which can be expressed as: $1:x::x:2$. Or more simply, the square of area 1 is to that of 2 as the square of 2 is to 4, which is constructed in the diameter ($1:2::2:4$).

If you play close attention, you will have no difficulty in observing that the relationship between triangle (0,-1,A) and triangle (1,A,1) is the same one we need in order to make the square of area 2.

Figure 4 Leg 1.5 of the triangle is to hypotenuse w as hypotenuse w— which will now be leg w of the next triangle—will be to 2, its hypotenuse. The which is expressed as: $1.5:w::w:2$, or speaking of the squares which these lines form $2.25:3::3:4$. Is line w a hypotenuse or a leg of a triangle? Explain this paradox to yourself, and your concept of a geometric mean will improve.



If you have followed this pedagogical this far, you will become aware that certain lower geometries are defined by higher processes, as we saw with circular action. Do you think politics functions in the same way? It is these different levels that the Greeks called powers or “*dynamis*”, and we have to be clear that these illustrations are merely shadows of the way our universe functions, and the way it always unfolds as proportional processes, such as economic processes between nations.

Let's conclude now with the idea of a continuous function. We have developed a simple process (the line), a double one (the square), and let's look at the paradox of

the cube. . . . Starting with a cube of volume 1, how would you construct a cube of volume 2? Archytas makes use of three continuous processes based on circular action to be able to master this process of greater complexity, constructing the cone, torus, and cylinder, functioning simultaneously like a three-voice musical piece for piano (**Figure 5**).

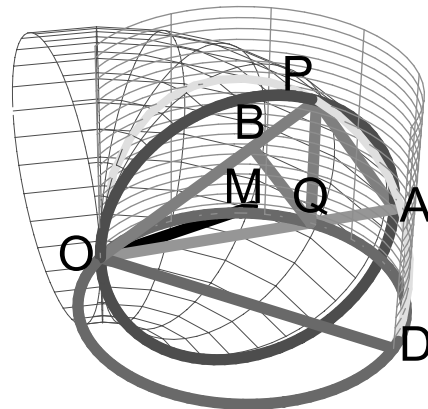

Figure 5 In the doubling of the square, we need one geometric mean, since, geometrically, from 1 to 4 you need 2, as 1 is to 2 as 2 is to 4 ($1:2::2:4$). Now the question is: With a side of length 1, you have a cube of volume 1 with a side of 2, you have a volume of 8. How many geometric means are there? $1:2:4:8$ and these means generate triangle OPA, which is generated by the intersection of the half-torus (vertical circle) and the horizontal circular cylinder, moving continuously at the point in which the length of the radius intersects that of the diameter by two geometric means OQ and OP, forming the following ratio:

$1:OQ::OQ:OP::OP:2$, since $OQ^2=OP$ and $2OQ=OP^2$, then $OQ^4=2OQ$ where $OQ^4/OQ=2$, so that $OQ^3=2$ and OQ =the cube root of 2, and in this way you obtain the cube root of 4. Have fun!

In fact, between 1 and 8 there are two geometric means. As has been said already, geometry alone is the most efficient projection of the world of ideas. That is why Archytas developed this construction which projects the idea which generates the two mean proportions which we need in the physical world, and which give us the side of the cube we are looking for, the cube root of 2 and the cube root of 4.

This is the method which leaders of this country must master to know how to affect the transcendental processes upon which the dynamic functioning of our country depends, and, in that way, avoid work which, although well-intentioned, wears us down personally and as a movement. We must act like the universe, based on least action, and then we will triumph, because, as Martin Luther King said, it is then that we shall have a cosmic ally.

tropic relationships congruent with the Golden Section.²

2. Something that is simply arbitrary or departs from the confines of natural beauty cannot be art. However, the mere imitation of natural beauty is not art. Art is what employs, and does not deviate from natural beauty, but makes use of that environment to carry out creative activity. Classical beauty is not a sensual object, but rather a relationship among people, and between the cognitive processes of the artist and the public.

3. The proper unity of science and art is essential, as the complete and integral incarnation of the qualities of the human mind that distinguish man from beast. A universal humanist Classical education demands such a unity.

4. Such art never descends to the banality of pure entertainment, but rather expresses a spiritual quality of cognitive human processes, which celebrate the law that each man and woman is created in the image of the Creator of this universe. Herein lies the superior moral authority which, as Shelley affirms, presents the poets as humanity's true legislators.

The Struggle of Modern Physical Science

I have recognized from experience that those who are completely Cartesian are not capable of discovery; there have been many beautiful discoveries since Descartes, but, as far as I know, not one of them has come from a true Cartesian. Descartes himself had a rather limited mind. He excelled all people in speculation, but he discovered nothing useful for the portion of life which falls under the senses, and nothing useful in the practice of the arts.—Gottfried Wilhelm Leibniz

As opposed to modern experimental science, Cartesian empiricism reduces the individual's knowledge to the "world" of the senses, while Leibniz advocates the idea that man is created in the image of the Creator, and as such, is capable of participating in the continuous development of creation, thus elevating him to the level of understanding those principles that are beyond the reach of the senses. This is the conception of science and of man that gave rise to the Renaissance.

This Renaissance tradition inspired by the science known as *Sphaerics* and the works of Kepler on planetary orbits is what led Leibniz to the development of the infinitesimal calculus, and his dynamic and anti-entropic conception of the universe.

This vision of dynamics is defended today by Lyndon LaRouche, as a representative of the Leibnizian tradition which laid the basis for the founding of the first republics in America.

2. Leonardo da Vinci (1452-1519) and Luca Pacioli (c. 1445-c. 1517) identified that the geometry of living processes differs from those of non-living ones, due to self-similar growth congruent with the Golden Section, a geometrical characteristic present in a logarithmic spiral, found also in the relationship between the side of the pentagon and its diagonal, equivalent to the so-called "golden mean."

Contrary to the empirical method, modern physical science is the practice of cognition by which you are able to discover, or as Plato would say, "remember," the universal principle from which your human nature is derived, and understand the principles that generate the "shadows" or the effects that present themselves as paradoxes in the material world (see Book 6 of Plato's *Republic*).

This is the fundamental principled dispute: the existence of principles against the idea that the only thing that exists is what we can perceive with our senses. The point here is: To what does matter respond? Does an atom behave the same way in air (abiotic) as it behaves in a living body? What exists in the universe that determines the behavior of this atom in different ways? As Vernadsky correctly notes, there are three phase-spaces—the abiotic, the biosphere, and the Nöosphere. In each of these, the different atoms (isotopes) order themselves in a different and higher-level way, and the principles that govern these phase-spaces are acting beyond simple matter and are connected among themselves. Physically, these phase-spaces continuously exchange matter. The form and order of matter depend on the principle governing phase-space in which it is found (see Box: "What Defines What We See?")

Conclusion

What we have to have make clear in any historical change, are the ideas upon which a Republic is founded. What is important are not the particulars of certain laws or rules, but ideas based on natural law, establishing that government and society pursue the happiness of its individuals. And this is what should govern the institutions as well as the actions of individuals.

Our objective is to make something beautiful of our lives, taking responsibility for changing history, as LaRouche develops in his document "The Historical Individual" (see www.larouchepub.com):

"On this account, the exceptional political leader who rescues his people from the precipice of self-inflicted cultural collapse, performs a function which expresses the same characteristics as the discovery of an experimentally validated universal physical principle. Rather than arguing for remedies within the bounds of the generally accepted culture which threatens to destroy that nation, the valid leader for a time of such crisis, does exactly what Shakespeare's self-doomed Hamlet refused to do. The adequate leader for a moment at the brink of systemic crisis, like the scientific discoverer at a critical juncture in his work, must lead the nation away from its suicidal instinct, to adopt sweeping changes in the axiomatic assumptions on which that society has been operating up to that point. The would-be, 'practical leader,' who seeks approval from the authority of prevalent popular opinion before acting, is, like Hamlet, a menace to his nation. The needed leader, is *an exceptional individual*."

This, thus, is our mission, principally as young adults over the next fifty years of the planet.

Infrastructure Projects

North America: NAWAPA-Plus

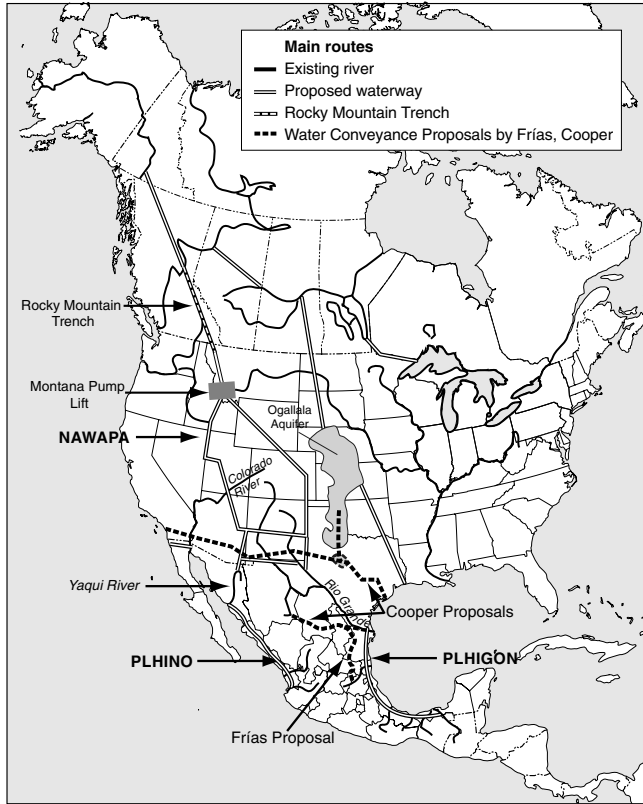

Source: Parsons Company, North American Water and Power Alliance Conceptual Study, Dec. 7, 1964; Hal Cooper; Manuel Frías Alcaraz; EIR.



Efficient transportation

Transrapid



Dams

U.S. Bureau of Reclamation



Scientific development

NASA

The central responsibility of the government of a nation is: the general welfare of the population, ensuring:

- Water
- Transportation
- Energy

Upon these physical economic foundations, the individuals of a Republic can develop, able to realize discoveries of universal physical principles which improve the conditions of life of subsequent generations.

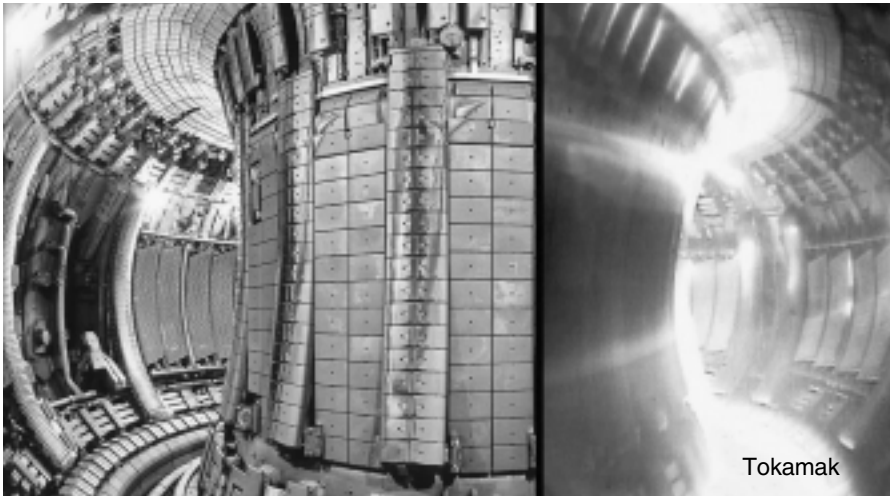

Tokamak

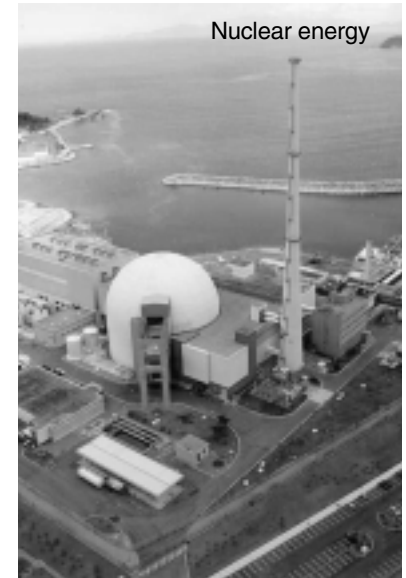

Nuclear energy

Framatom

Throw the Bums Out

Syndicated columnist Robert Novak weighed in on Sept. 14 with his own account of former Deputy Secretary of State Richard Armitage's role in leaking the identity of former CIA clandestine officer Valerie Plame, charging that Colin Powell's deputy had gone out of his way to "out" the wife of Ambassador Joseph Wilson. While Novak's account of his private discussion with Armitage may prove accurate, it says nothing about the underlying subject of Special Counsel Patrick Fitzgerald's probe: Was there a politically driven policy decision at the White House to expose Valerie Plame? And if so, who was responsible?

Given that the issue of the impeachability of both President Bush and Vice President Cheney has become Topic Number One in Washington over the past few weeks, the Plame affair takes on new significance.

Some things are clear, even without access to any of the privileged grand jury and Special Counsel records. First, there were a number of senior Bush Administration officials who participated in the feeding frenzy of leaks against Ambassador Wilson and Valerie Plame—including Vice Presidential chief of staff Lewis Libby and White House deputy chief of staff Karl Rove. This was a concerted campaign, not the action of a single individual.

Second, *EIR*'s own sources had reported many months ago that the first Executive Branch meeting on Joe Wilson had taken place in March 2003 in the Office of the Vice President—prior to the U.S. invasion of Iraq. The occasion was the United Nations Security Council testimony by Dr. Mohamed ElBaradei, head of the International Atomic Energy Agency (IAEA). ElBaradei revealed that the purported Niger government documents, "proving" that Saddam Hussein had been seeking large quantities uranium from the African state, were shoddy forgeries. Within 24 hours of the ElBaradei testimony, Joe Wilson appeared on CNN and suggested that the White House review its own files, because they would show that they knew a year earlier that the Iraq-Niger uranium plot reports were dubious at best. The Wilson TV appearance, on the eve of the U.S. invasion, set off alarm bells, according to *EIR*'s sources, and the Cheney-led witchhunt was on.

According to a recently published book by *News-*

week's Michael Isikoff and *The Nation's* David Corn, Valerie Plame was not merely a CIA "non-official cover" (NOC) officer. At the time of the Iraq invasion, she was an important figure in the Counterproliferation Division of the Directorate of Operations, in charge of operations for a special Iraq Task Force, charged with recruiting assets with first-hand knowledge of Iraq's weapons of mass destruction. By the time of the ElBaradei testimony at the UN, Plame was in charge of a large team of CIA officers, who had been recruiting assets inside Iraq and Iran. In short, she was one of the best-informed officials in the intelligence community about what was really going on inside Iraq, and the indications are that the CIA—despite intense pressure from Cheney and Libby—was not buying into the idea that Saddam's Iraq was brimming with WMD.

The leak to Novak did serious harm to the U.S. intelligence community's counterproliferation efforts, beyond the fact that it wrecked the career of an important young CIA officer, who has now left the Agency.

Which brings us to what may emerge in the weeks ahead as the "smoking gun" of the entire affair: Dick Cheney's copy of the *New York Times* July 6, 2003 column by Joe Wilson, "What I Did Not Find in Africa," complete with handwritten notes from the Veep. We hope that Special Counsel Fitzgerald will grill the Vice President on the events surrounding that annotated article—including the precise date when he scribbled his comment about the Wilson Niger trip being a "junket arranged by his wife."

Given the pile-up of charges against the President and Vice President, the question of Cheney's role in the "Get Joe Wilson and Valerie Plame" affair may very well rise to the level of high crimes and misdemeanors. Under any circumstances, the need to get to the bottom of the Wilson-Plame affair remains a priority—even in the wake of the Armitage revelations.

It is our belief that we have reached the point that the impeachment of Bush and Cheney passed from a partisan issue to an issue of vital national security for our Constitutional Republic. As Lyndon LaRouche states in this issue of *EIR*, it is high time that American patriots mobilize behind the demand: Throw the bums out!

SEE LAROUCHE ON CABLE TV

All programs are *The LaRouche Connection* unless otherwise noted. (*) Call station for times.

INTERNET

- ACCESSPHOENIX.ORG
Click *Live Webcast*
Fri: 6 pm
(Pacific Time only)
LAROUCHEPUB.COM
Click *LaRouche Writings*
(Available 24/7)
- SCANTV.ORG
Click *Scan Web*
Wed: 4 pm
(Pacific Time only)

ALABAMA

- BIRMINGHAM Ch.4
Wed: 11-11:30 pm
- UNIONTOWN Ch.2
Mon-Fri: every 4 hrs.
Sun: Afternoons

ALASKA

- ANCHORAGE Ch.10
Thu: 10 pm

ARIZONA

- PHOENIX Ch.98
Fri: 6 pm
- PHOENIX VALLEY
Quest Ch.24
Fri: 6 pm

ARKANSAS

- CABOT Ch.15
Daily: 8 pm

CALIFORNIA

- BEVERLY HILLS
Adelphia Ch.37
Wed: 4 pm
- BREA Ch.98
Thu: 6:30-10:30 pm
- CARLSBAD
Adelphia Ch.3
1st/3rd Wed: 10 pm
- CLAY/CONCORD
Comcast Ch.26
2nd Tue: 7 pm
Astound Ch.31
Tue: 7:30 pm
- CONTRA COSTA
Comcast Ch.26
2nd Tue: 7 pm
- COSTA MESA
Comcast Ch.35
Wed: 10 pm
- E.LOS ANGELES
Adelphia Ch.98
Mon: 2 pm
- HOLLYWOOD
Comcast Ch.24
Thu/Fri: 4-4:30 pm
- LANCASTER
- PALMDALE
Adelphia Ch.36
Sun: 1 pm
- LONG BEACH
Analog Ch.65/69
Digital Ch.95
4th Tue: 1-1:30 pm
- LOS ANGELES
Adelphia Ch. 98
Wed: 3-3:30 pm
- MARINA DEL REY
Adelphia Ch.98
Wed: 3-3:30 pm
Comcast Ch.24
Thu & Fri: 4 pm
- MIDWILSHIRE
Comcast Ch.24
Thu/Fri: 4-4:30 pm
- N.ORANGE COUNTY
Adelphia Ch.95/97/98
Fri: 3:30-4 pm
- NE SAN.FDO.VLY.
Comcast Ch.20
Wed: 4 pm
- OJAI
Adelphia Ch.10
Mon: 12:30 pm

- SANTA MONICA
Adelphia Ch.77
Wed: 3-3:30 pm
- VENTURA CITY
Comcast/Wave Ch.6
Mon: 7 am
- VENTURA COUNTY
Adelphia/Comcast
Channels 8/16/25
Mon: 1 pm
- WALNUT CREEK
Comcast Ch.6
2nd Tue: 7 pm
Astound Ch.31
Tue: 7:30 pm
- W.HOLLYWOOD
Adelphia Ch.3
Wed: 4 pm
- W.SAN FDO.VLY.
TimeWarner Ch.34
Wed: 5:30 pm

COLORADO

- DENVER
Comcast Ch.57
Sat: 1 pm

CONNECTICUT

- GROTON—Ch.12
Mon: 5 pm
- NEW HAVEN Ch.23
Sat: 6 pm

DISTRICT

- WASHINGTON
Comcast Ch.5
Starpower Ch.10
Irregular Days/Times

FLORIDA

- ESCAMBIA
Cox Ch. 4
Last Sat: 4:30 pm

IDAHO

- MOSCOW Ch.11
Mon: 7 pm

ILLINOIS

- CHICAGO Ch.21
Comcast/RCN/WOW*
- PEORIA COUNTY
Insight Ch.22
Sun: 7:30 pm
- QUAD CITIES
Mediacom Ch.19
Thu: 11 pm

IOWA

- QUAD CITIES
Mediacom Ch.19
Thu: 11 pm

KENTUCKY

- BOONE/KENTON
Insight Ch.21
Sun: 1 am
Fri: Midnight
- JEFFERSON
Insight Ch.98
Fri: 2-2:30 pm

MAINE

- PORTLAND
TimeWarner Ch.42
Mon: 1&11 am,5 pm

MARYLAND

- ANNE ARUNDEL
Annapolis Ch.76
Millenium Ch.99
Sat: 12:30 am
Sun: 12:30 am
Tue: 6:30 pm
- MONTGOMERY
Comcast Ch.21
Fri: 10:30 pm
Sun: 1 pm
- P.G.COUNTY
Comcast Ch.76
Thu: 11:30 am

MASSACHUSETTS

- BRAINTREE
Comcast Ch.31
BELD Ch.16
Tue: 8 pm
- CAMBRIDGE
Comcast Ch. 10
Tue: 2:30 pm
Fri: 10:30 am
- WALPOLE
Comcast Ch.8
Tue: 1-1:30 pm

MICHIGAN

- BYRON CENTER
Comcast Ch.25
Mon: 2 & 7 pm
- DETROIT
Comcast Ch.68
Unscheduled pop-ins
- KALAMAZOO
Charter Ch. 20
Thu: 11 pm
- KENT COUNTY
Comcast Ch.25
Fri: 1:30 pm
- N.KENT COUNTY
Charter Ch.22
Wed: 3:30 & 11 pm
- LAKE ORION
Comcast Ch.10
Mon/Tue: 2 & 9 pm
- LIVONIA
Brighthouse Ch.12
Thu: 3 pm
- MT.PLEASANT
Charter Ch. 3
Tue: 5:30 pm
Wed: 7 am
- PORTAGE
Charter Ch.20
(Coming Soon!)
- SHELBY TWP.
Comcast Ch.20
WOW Ch.18
Mon/Wed: 6:30 pm
- WAYNE COUNTY
Comcast Ch.16/18
(Coming Soon!)
- WYOMING
Comcast Ch 25
Wed: 9:30 am

MINNESOTA

- BURNSVILLE
EGAN
Comcast Ch.14
S,T,T,S: 4:30 pm
M,W,F: 4:30 am
- CAMBRIDGE
US Cable Ch.10
Wed: 6 pm
- COLD SPRING
US Cable Ch.10
Wed: 6 pm
- COLUMBIA HTS.
Comcast Ch.15
Wed: 8 pm
- DULUTH Ch.20
Mon: 9 pm
Wed: 12 pm
Fri: 1 pm
- MINNEAPOLIS
TimeWarner Ch.16
Tue: 11 pm
- MINNEAPOLIS
(Northern Burbs)
Comcast Ch.15
Thu: 3 & 9 pm
- NEW ULM Ch.14
Fri: 5 pm
- PROCTOR Ch.12
Tue: 5 pm to 1 am
- ST.CLOUD AREA
Charter Ch.12
Mon: 9:30 pm

- ST.CROIX VLY.
Comcast Ch.14
Thu: 1 & 7 pm
Fridays—9 am
- ST.LOUIS PARK
TimeWarner Ch.15
Wed & Fri:
12 am, 8 am, 4 pm
- ST.PAUL
(city only)
Comcast Ch.15
Fri: 11 pm
- ST.PAUL
(North suburbs)
Comcast Ch.14
Mon: 7 pm
Tue: 3 & 11 am
- St.PAUL
(S&W suburbs)
Comcast Ch.15
Wed: 10:30 am
Fri: 7:30 pm
S.WASHINGTON
Comcast Ch.14
Thu: 8 pm

MISSOURI

- ST.LOUIS
Charter Ch.22
Wed: 5 pm
Thu: 12 Noon

NEVADA

- WASHOE
Brighthouse Ch.16
Thu: 2 pm

NEW HAMPSHIRE

- MANCHESTER
Comcast Ch.23
Thu: 4:30 pm

NEW JERSEY

- HADDEN TWP.
Comcast Ch.19
Sun: 8 am
- MERCER COUNTY
Comcast*
TRENTON Ch.26
3,4 Fri: 6-6:30 pm
WINDSOR'S Ch.27
Mon: 5:30-6 pm
- MONTVALE/MAHWAH
Cablevision Ch.76
Mon: 5 pm
- PISCATAWAY
Cablevision Ch.22
Thu: 11:30 pm
- UNION
Comcast Ch.26
Unsched. Fillers

NEW MEXICO

- ALBUQUERQUE
Comcast Ch.27
Thu: 4 pm
- ANTHONY/SUNLAND
TimeWarner Ch.15
Wed: 5:05 pm
- LOS ALAMOS
Comcast Ch.8
Wed: 10 pm
- SANTA FE
Comcast—Ch.8
Thu: 9 pm
Sat: 6:30 pm
Wed: 9 pm
- SILVER CITY
Conley Productions
Daily: 8-10 pm
- TAOS Ch.2
Thu: 7 pm

NEW YORK

- ALBANY
T/W Ch.18
Wed: 5 pm
- BRONX
Cablevision Ch.70
Fri: 4:30 pm

- BROOKLYN
T/W Ch.35
Cablevision Ch.36
2nd Mon: 9:30 am
- CHEMUNG
T/W Ch.1/99
Tue: 7:30 pm
- ERIE COUNTY
Adelphia Ch.20
Thu: 10:35 pm
- IRONDEQUOIT
T/W Ch.15
Mon/Thu: 7 pm
- JEFFERSON
- LEWIS
T/W Ch.99
Unscheduled pop-ins
- NIAGARA COUNTY
Adelphia Ch.20
Thu: 10:35 pm
- ONEIDA
T/W Ch.99
Thu: 8 or 9 pm
- PENFIELD Ch.15
Penfield Comm. TV*
- QUEENS
T/W Ch.35
Tue: 10:30 am
- QUEENSBURY Ch.71
Adelphia Ch.71
Mon: 7 pm
- RIVERHEAD Ch.20
Wed: 8 pm
- ROCHESTER Ch.15
Sat: 4 pm; Wed: 9 pm
- ROCKLAND Ch.76
Mon: 5 pm
- SCHENECTADY
TimeWarner Ch.16
Sat: 1:30 am
Fri: 1 p.m.
- STATEN ISL.
TimeWarner
Thu: 11 pm (Ch.35)
Sat: 8 am (Ch.34)
- TOMKINS
Sat: 6 pm
Sun: 12:30 pm
- TRI-LAKES
Adelphia Ch.2
Sun: 7 am, 1 pm, 8 pm
- WEBSTER Ch.12
Wed: 9 pm

NORTH CAROLINA

- HICKORY
Charter Ch.3
Tue: 10 pm

OHIO

- AMHERST
T/W Ch.95
Every Day!
12 Noon & 10 pm
- CUYAHOGA
T/W Ch.21
Wed: 3:30 pm
- OBERLIN
Cable Co-Op Ch.9
The: 8 pm

OKLAHOMA

- NORMAN
Cox Ch.20
Wed: 9 pm
- OREGON
• LINN/BENTON
Comcast Ch.29
Tue: 1 pm
Thu: 9 pm
- PORTLAND
Tue: 6 pm (Ch.22)
Thu: 3 pm (Ch.23)

RHODE ISLAND

- E.PROV. Ch.18
Tue: 6:30 pm

- STATEWIDE
RI Interconnect
Cox Ch.13
Tue:10-10:30 am

TEXAS

- DALLAS
AT&T Ch.13-B
Tue: 10:30 pm
- EL PASO COUNTY
TimeWarner Ch.15
Wed: 5:05 pm
- HOUSTON
TimeWarner Ch.17
TV Max Ch.95
Wed: 5:30 pm
Sat: 9 am
Wed, 8/6: 8 pm
- KINGWOOD
Cedridge Ch.98
Wed: 5:30 pm
Sat: 9 am
Wed, 8/6: 8 pm

VERMONT

- GREATER FALLS
Adelphia Ch.10
Mon,Wed,Fri: 1 pm
- MONTPELIER
Adelphia Ch.15
Tue: 9 pm
Wed: 3 pm

VIRGINIA

- ALBERMARLE
Adelphia Ch.13
Sun: 4 am
Fri: 3 pm
- ARLINGTON
Comcast Ch.33
Mon: 1 pm
Tue: 9 am
- CHESTERFIELD
Comcast Ch.6
Tue: 5 pm
- FAIRFAX Ch.10
1st & 2nd Wed: 1 pm
- LOUDOUN
Comcast Ch.23
Wed: 6 pm
- ROANOKE Ch.19
Tue: 7 pm
Thu: 2 pm

WASHINGTON

- KING COUNTY
Comcast Ch.29/77
Sat: 2 pm
- TRI CITIES
Ch.12/13/99
Mon: 7 pm
Thu: 9 pm
- WENATCHEE
Charter Ch.98
Thu: 4 pm

WISCONSIN

- MADISON Ch.4
Tue: 1 pm monthly
- MARATHON
Charter Ch.10
Thu: 9:30 pm
Fri: 12 noon
- WYOMING
• GILLETTE
Bresnan Ch.31
Tue: 7 pm

If you would like to get *The LaRouche Connection* on your local cable TV system, please call Charles Notley at 703-777-9451, Ext. 322. For more information, visit our Website at <http://www.larouchepub.com/tv>

SUBSCRIBE TO

EIR

Executive Intelligence Review

EIR Online

EIR

gives subscribers one of the most valued publications for policymakers—the weekly journal that has established Lyndon LaRouche as the most authoritative economic forecaster in the world today.

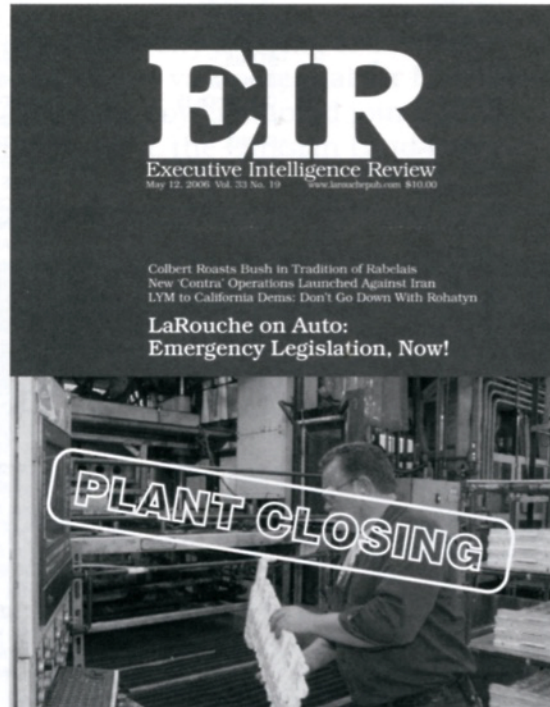

EIR Online

issued every Monday, includes early access to most of the print magazine, as well as fast-breaking communications from LaRouche, up-to-the minute world news, and a special historical feature.



I would like to subscribe to **Executive Intelligence Review**

U.S.A. and Canada:

- \$396** for one year
- \$225** for six months
- \$125** for three months

SPECIAL OFFER

- \$446** for one year
EIR Print plus EIR Online*

Outside U.S.A. and Canada:

- \$490** for one year
- \$265** for six months
- \$145** for three months

SPECIAL OFFER

- \$540** for one year
EIR Print plus EIR Online*

I would like to subscribe to **EIR Online***

- \$360** for one year
- \$60** for two months

EIR Online can be reached at:

www.larouchepub.com/eiw

Call **1-888-347-3258** (toll-free)

Standard Class shipping. Please call for First Class rates.

Name _____

Company _____

Address _____

City _____ State _____ Zip _____ Country _____

Phone (_____) _____ E-mail address* _____

* E-mail address required for EIR Online subscriptions

I enclose \$ _____ check or money order

Make checks payable to

EIR News Service Inc.

P.O. Box 17390, Washington, D.C. 20041-0390

Please charge my MasterCard Visa

Card Number _____

Signature _____

Expiration Date _____