

# EIR

Executive Intelligence Review

October 26, 2007 Vol. 34 No. 42 [www.larouche.com](http://www.larouche.com) \$10.00

Bering Strait Tunnel Dominates Arctic Energy Summit  
Dump Cheney: Last, Best Chance To Stop World War III  
Blackwater Nazis Take Aim: Kristallnacht in Virginia?

**Nobel Economics Prize:  
The Price Is Usually Wrong!**



Founder and Contributing Editor:

Lyndon H. LaRouche, Jr.

Editorial Board: Lyndon H. LaRouche, Jr., Muriel

Mirak-Weissbach, Antony Papert, Gerald Rose,

Dennis Small, Edward Spannaus, Nancy

Spannaus, Jeffrey Steinberg, William Wertz

Editor: Nancy Spannaus

Managing Editor: Susan Welsh

Assistant Managing Editor: Bonnie James

Science Editor: Marjorie Mazel Hecht

Technology Editor: Marsha Freeman

Book Editor: Katherine Notley

Photo Editor: Stuart Lewis

Circulation Manager: Stanley Ezrol

#### INTELLIGENCE DIRECTORS

Counterintelligence: Jeffrey Steinberg, Michele Steinberg

Economics: Marcia Merry Baker, Paul Gallagher

History: Anton Chaitkin

Ibero-America: Dennis Small

Law: Edward Spannaus

Russia and Eastern Europe:

Rachel Douglas

United States: Debra Freeman

#### INTERNATIONAL BUREAUS

Bogotá: Javier Almaro

Berlin: Rainer Apel

Copenhagen: Poul Rasmussen

Houston: Harley Schlanger

Lima: Sara Madueño

Melbourne: Robert Barwick

Mexico City: Rubén Cota Meza

New Delhi: Ramtanu Maïtra

Paris: Christine Bierre

United Nations, N.Y.C.: Leni Rubinstein

Washington, D.C.: William Jones

Wiesbaden: Göran Haglund

#### ON THE WEB

e-mail: eirms@larouchepub.com

www.larouchepub.com

www.larouchepub.com/eiw

Webmaster: John Sigerson

Assistant Webmaster: George Hollis

---

EIR (ISSN 0273-6314) is published weekly (50 issues), by EIR News Service, Inc., 729 15th St. N.W., Washington, D.C. 20005. (703) 777-9451

**European Headquarters:** E.I.R. GmbH, Postfach 2308, D-65013 Wiesbaden, Bahnstrasse 9-A, D-65205, Wiesbaden, Federal Republic of Germany Tel: 49-611-73650

Homepage: <http://www.eirna.com>

e-mail: [eirna@eirna.com](mailto:eirna@eirna.com)

Director: Georg Neudekker

**Montreal, Canada:** 514-855-1699

**Denmark:** EIR I/S, Sankt Knuds Vej 11, basement left, DK-1903 Frederiksberg, Denmark. Tel.: +45 35 43 60 40. Fax: +45 35 43 87 57. e-mail: [eirdk@hotmail.com](mailto:eirdk@hotmail.com).

**Mexico:** EIR, Manual Ma. Contreras #100, Despacho 8, Col. San Rafael, CP 06470, Mexico, DF. Tel.: 2453-2852, 2453-2853.

Copyright: ©2007 EIR News Service. All rights reserved. Reproduction in whole or in part without permission strictly prohibited.

Canada Post Publication Sales Agreement #40683579

**Postmaster:** Send all address changes to EIR, P.O. Box 17390, Washington, D.C. 20041-0390.

# EIR

## From the Assistant Managing Editor

Perhaps if the trio of Nobel Prize winning economists had studied biology instead of monetarist economics, they would have been familiar with the mating habits of the praying mantis, in which the female ingests the head of her mate during the act of love. As it is, the devouring of such U.S. financial establishments as Goldman Sachs by the Bank of England & Co., represents the equivalent, in the banking domain, of the sex act of the mantises. It is this strange state of affairs that Lyndon LaRouche addresses in our *Feature* this week: “Nobel Economics Prize: The Price Is Always Wrong!” As he observes, “This current, scandalous Nobel award is all too relevant to the kind of policy-shaping which had already plunged the present world monetary-financial system into its presently onrushing, terminal phase of self-disintegration.” However, LaRouche notes, provided that we dump the present Liberal free-trade system—represented on our cover by the East India Company’s slave trade—we can still rescue humanity from the threatened New Dark Age. This is possible because, LaRouche notes optimistically, “Human nature is not inherently evil,” despite the kind of depravity found among the circles of Vice President Dick Cheney and his like.

To see the truth of this, we need only to look at our own history, which we do this week in our *American System* section, with the inauguration of a new series on the American patriotic tradition, and its historical enemy, the British/Venetian oligarchy: “James Fenimore Cooper and the Society of the Cincinnati,” by Patrick Ruckert. Cooper, a leader of the second generation of American revolutionaries, spread the ideas of 1789 around the world through his novels and histories.

But this tradition is not lost, even today. The expansion of our scientific mastery over the universe for the betterment of mankind, was given powerful expression at a conference in Anchorage, Alaska in mid-October, where Americans, Russians, and others came together at the Arctic Energy Summit, to promote the Bering Strait Tunnel-Rail Link as part of the World Land-Bridge *Economics*.

For the strategic overview this week, see Helga Zepp-LaRouche’s *International* lead, which poses the existential question: “Third World War or New World Economic Order.”



## Cover This Week

*Would the British East India Company's slave traders have won the Nobel Prize for Economics? Quite likely.*



### **4 Nobel Economics Prize: The Price Is Usually Wrong!**

By Lyndon H. LaRouche, Jr. The Nobel Committee's folly in awarding the Economics prize to Leonid Hurwicz, Eric Maskin, and Roger B. Myerson, "for having laid the foundations of mechanism design theory," illustrates the nature of some of the most important causes for the current chain-reaction-like, physical disintegration of the world's monetary-financial system.

## National

### **22 Dump Cheney Now: The Last Best Chance To Stop World War III**

The danger of world war will continue to exist as long as Vice President Dick Cheney is in office. Fear that he may prevail has prompted a number of prominent figures to revisit the issue of the Sept. 11, 2001 asymmetric warfare attacks on the United States.

### **24 Blackwater Nazis Aim Homeward: Kristallnacht in Virginia?**

Greg Ahlemann, candidate for sheriff in Virginia's Loudoun County, is part of an international theocratic, fascist underground, connecting the Blackwater USA corporate leadership to armageddonist Protestant and Catholic operatives.

## International

- 26 Third World War or New World Economic Order?**  
Helga Zepp-LaRouche reports that the artificial staging of an incident à la the Gulf of Tonkin, to create the pretext for a U.S. military strike against Iran, would lead to World War III. The alternative would be collaboration between the United States and Russia to build the Eurasian Land-Bridge, centered around a Bering Strait rail tunnel, which is being actively pursued by Russia, and advocated by some circles in the United States.
- 28 U.S.-Russian Missile Defense Talks Have Reached a Turning Point**
- 31 Caspian Summit: Putin Puts Forward a War-Avoidance Plan**
- 33 Are Israel and Syria Holding Peace Talks?**
- 35 Former Mossad Chief: Iran Not an Existential Threat**

## Economics

- 36 Spotlight on Bering Strait at Arctic Energy Summit**  
The idea of transforming the Earth through great projects of physical economy, was presented with passion by the Russian delegates at the Arctic Energy Summit in Alaska.
- 38 Dick Cheney's Oil Law for Iraq Is Neo-Colonial Theft**
- 41 Colombian LaRouche Movement: Vote for Great Projects, Maglev**
- 43 Make What Is Reasonable Possible: Darién Train and Bering Strait Tunnel**
- 44 Engineering Projects for Development of the Atrato Region in Colombia**  
By Dr. Héctor A. Múnera, who teaches at the Department of Physics, National University of Colombia in Bogotá.
- 48 Danish Campaign for Maglev Picks Up Speed**
- 50 The Promise of Fusion Power**  
Dr. Stephen Dean of Fusion Power Associates prepared this video address for the Schiller Institute's conference on "The Eurasian Land-Bridge Becomes a Reality," in Kiedrich, Germany, on Sept. 15-16.
- 55 PBMR: Clean, Safe, and Affordable Energy**  
A paper presented to the Schiller Institute's Kiedrich conference by Tom Ferreira, Senior Manager of Corporate Communications for Pebble Bed Modular Reactor (Pty) Ltd. of the Republic of South Africa.
- 61 Business Briefs**

## American System

- 62 The Fight for the American Republic: James Fenimore Cooper and the Society of the Cincinnati**  
By Patrick Ruckert. This is the first in a series of articles on the American patriotic tradition, and its historical enemy, the British/Venetian oligarchy. The purpose is to inject the issue of the American System, and the quality of republican leadership and culture that must be revived, into the political process today.
- 70 From *The Bravo*: 'A Republic, If You Can Keep It'**

## Departments

- 60 Banking**  
The City of London

## Editorial

- 72 The Sex Life of Goldman Sachs**

## NOBEL ECONOMICS PRIZE

# The Price Is Usually Wrong!

by Lyndon H. LaRouche, Jr.

---

*While the snow piles up to record heights in the Swiss Alps, “global warming” hoaxster Al Gore is not the only fellow enjoying the receipt of a Nobel prize for fraud. Just at the moment that the present world monetary system has entered its terminal-collapse phase, three relevant, intellectually culpable U.S. academics, the University of Minnesota’s Leonid Hurwicz, Princeton’s Eric S. Maskin, and Chicago University’s Roger B. Myerson, have been awarded this year’s prize “for having laid the foundations of mechanism design theory.” The Nobel committee’s folly in this case illustrates the nature of some of the most important causes for the currently ongoing, chain-reaction-like, physical disintegration of the world’s present monetary-financial system.*

---

First of all, it must appear that the Nobel Committee’s award to Hurwicz, Maskin, and Myerson, signifies that that Committee does not presently require a demonstration of what scientific tradition defined as a “crucial,” or *unique* (*einzigartig*; Riemann<sup>1</sup>) proof of principle in defining its standards for awards. This is not exactly a new problem in the Committee’s process of making awards in the field of economics; years ago, I wryly suggested that I might consider suing the Committee for defamation were it ever to proffer an award in economics to me (or, implicitly, to any other qualified scientist in the field). The hilarious feature of the Committee’s referenced announcement of the economics prize, is that the award has been publicized today, precisely at the moment that the way of thinking represented by the current trio, has just recently unleashed a design for the already onrushing,

---

1. Bernhard Riemann, *Über die Hypothesen, welche der Geometrie zu Grunde liegen* (1854), in Riemann’s *Gesammelte Mathematische Werke* (New York: Dover Reprint Edition, 1953).

greatest single monetary-policy disaster in all modern world history since the Weimar Germany crisis of 1923!<sup>2</sup>

For our purposes in *EIR* today, the significance of that Nobel award, apart from the fact of the relevant piece’s essential scientific incompetence, is that that incompetence is an all too typical symptom of the depth of the intellectual decadence which pollutes so much of the kind of already pervasive ideology influencing the field of economics, national political trends, and related subjects. This is a trend to be assessed as reflecting the increasingly sick state of mind which has been a critical contributing factor in the presently onrushing global social-economic disaster.

The formal, academic, and related origins of the dogma presented by the same embarrassing trio, are to be traced to the point, more than a century ago, in Bertrand Russell’s notorious *Principles of Mechanics* and, also, Russell’s *Principia Mathematica*.<sup>3</sup> The immediately obvious link is to Russell’s *Principles of Mechanics*, but, as the 1930-31 work of Kurt Gödel attests,<sup>4</sup> the deeper epistemological implications of

---

2. The precedent for this event is the role of mathematicians Myron Scholes et al. in the crafting of the August-October 1998 crash of LTCM, an experience from which, it appears, Henry Paulson seems to have learned nothing crucial. Actually, speaking of “carbon,” the philosophy of current Liberal economic-financial policies is close to being a carbon-copy of those practices of the Fourteenth-Century Lombard bankers which created that century’s infamous “New Dark Age.” Such among today’s fools are not to be condemned as much for being bad scholars, as denounced for being madmen running amok spreading an awful disease.

3. Bertrand Russell, *Principles of Mechanics* (1903) and *Principia Mathematica* (1912). Russell’s conceptions strongly echo the mysticism of Ernst Mach’s *The Analysis of Sensations* (1897), and may, arguably, have been largely derived from the suggestions provided by Mach’s work.

4. Kurt Gödel, “On Formally Undecidable Propositions of Principia Mathe-



“While the snow piles up to record heights in the Swiss Alps, ‘global warming’ hoaxster Al Gore is not the only fellow enjoying the receipt of a Nobel prize for fraud.” Left to right are Nobel Economics Prize winners Eric S. Maskin, Leonid Hurwicz, and Roger B. Myerson.

Russell’s influence are revealed in the inherent failure of Russell’s principal, underlying argument in the latter of the two works.

For our purposes here, the immediately relevant monetarist dogmas derived from Russell’s radical thesis respecting scientific method generally, are chiefly associated, today, with the stream of ideology traced from Russell devotee John von Neumann’s notion of a theory of economic games. Following that work by von Neumann and his associates, the development of the school of monetarism with which the present Nobel trio has been associated, has been the intrinsically, wildly pro-Malthusian cult of what is known in relevant professional circles as *Cambridge systems analysis*, as that cult is typified by the Cambridge disciples assembled around the former Soviet and other following of the Laxenberg, Austria International Institute for Applied Systems Analysis (IIASA).

In the post-World War II U.S.A., this international school of Russellite “econometrics” coordinated by the Cambridge systems-analysis group, came to be represented inside U.S. academic stirrings by such U.S. followers of Russell and von Neumann as the Cowles Foundation circles of George Dantzig, Tjalling Koopmans, Albert Tucker, George Marshak, and Kenneth Arrow, as much as the more prominent work of von Neumann and Oskar Morgenstern.<sup>5</sup> Inside the

matika and Related Systems,” in *Kurt Gödel Collected Works* Vol. I (Oxford: Oxford University Press, 1986).

5. John von Neumann and Oskar Morgenstern, *The Theory of Games and Economic Behavior* 3rd edition (Princeton: Princeton University Press, 1953).

U.S.A. itself, this network of Russell devotees such as Norbert Wiener and von Neumann, was coordinated, most notably, through the Josiah Macy, Jr. Foundation and the offshoots of that Foundation’s Cybernetics-project at the Massachusetts Institute of Technology’s RLE. Inside the Soviet Union, one branch of this influence was represented by collaboration with L.V. Kantorovich and, later, the Global Systems Analysis group associated with the Austria-based branch of the Cambridge Systems Analysis group’s ideological captive IIASA, the latter a Club of Rome-allied group whose influence contributed in a major way to the Soviet Union’s 1989-1992 collapse.<sup>6</sup>

These presently global Russell/Russellite connections are key for understanding the particular form of *dementia* in the method encountered in the school of the three current Nobel economics prize-winners and their like.

Unfortunately, as I have already emphasized here, the current Nobel trio’s celebrity is not merely an academic matter. This current, scandalous Nobel award is all too relevant to the kind of policy-shaping which had already plunged the world monetary-financial system into its presently onrushing, terminal phase of self-disintegration. (The real world, outside monetary dogmas, could survive this, provided we now immediately dump the present, Liberal monetarist—“free trade” system itself.) Without the widespread toleration for the spe-

6. I had warned the Soviet government explicitly of this risk (“in about five years”) during my part in back-channel U.S.-Soviet SDI discussions of February 1983, and had repeated that warning publicly, and repeatedly, since later Spring of that year.

cific type of clinical insanity echoed by the current award, the onrushing general collapse of the world's present monetary-financial system, would never have been permitted to reach its present breakdown-phase. The world economy today needs the designs of Myron Scholes and of Hurwicz, Maskin, and Myerson, about as much as a sufferer from the common cold needs the curative powers of a heavy dose of cyanide.

---

## 1. Geometry & Physical Science

---

The disorderly minds typified by the listing of exemplary persons and associations which I have just presented above, reflect two pathological features found in, respectively, medieval and modern European political-economy. These are, respectively, the pro-Aristotelean, "old Venetian," medieval tradition, and the modern, *Liberal* faction of Paolo Sarpi et al. The latter school, to which the three relevant Nobel cases belong, is the philosophical *Liberalism* which, while modern, traces its immediate philosophical ancestry, directly to that medieval irrationalist William of Ockham whom some moderns quaintly refer to by the seemingly scholarly, Latin name of "Occam."

The dogma presented summarily by that relevant trio, is a radically Sophist expression of a much-degenerated version of modern, "new Venetian," Sarpian philosophical *Liberalism*, a version traced to the radical extremes of such modernist perversion of taught academic practice as that typified by the radically positivist, and frequently hysterical followers of Ernst Mach.<sup>7</sup>

The earlier, medieval, Aristotelean kind of system, is to be treated, methodologically, as a system based upon an underlying assumption of a society ruled by an axiomatically fixed, deductive form of intent. This fixed intent is typified by the models of both the inherently Sophist dogma of Euclidean geometry, and that related, medieval notion of the Euclidean space adopted by the Roman imperial hoaxster Claudius Ptolemy, which was still standard methodological doctrine during my time of uncomfortable exposure to such miserable elements of secondary and higher education. The later, modified form of a modern neo-Euclidean system of René Descartes et al., is premised upon the assumption of a Sophist's quality of variable intent which is otherwise identified as political-philosophical "Liberalism."

Competent modern science, as established by Cardinal Nicholas of Cusa and his followers, adopts neither of these two ideological alternatives. As Albert Einstein and V.I. Vernadsky have emphasized the leading outcome of Twentieth-

---

7. Typical is the case of Berlin during the period of World War I, when the Machian fanatics of Germany and Austro-Hungary conducted a lynch-mob-like effort to demolish the great Max Planck. Bertrand Russell was a relevant figure from afar in this atrocity, as he had been a then relatively new player in the systematic mental destruction of Georg Cantor.

Century physical science more recently, today's competent modern science is "organically" Riemannian, and is rooted in the principled form of the actual development of the body of experimental physical science, from Cusa, through the work of Johannes Kepler, through Riemann.<sup>8</sup>

### Physical Geometry

In treating cases such as the trio of Hurwicz, Maskin, and Myerson, we must take into account the ideological effect of a certain, historically crucial break between present and ancient forms of knowledge in the fields of physical science. I refer here to a "dark age"-like break, an ideological gap in the history of science, between the period of ancient scientific progress dominated by the method of the Pythagoreans and the Platonic Academy, and the reappearance of science during modern Europe's Fifteenth-Century Renaissance, onwards. This break, associated with the interval of the rise, since about 200 B.C., of the empires of Rome, Byzantium, and the Venetian-Crusader medieval system, created a functional gap in what might have been, otherwise, the continuity of ancient through contemporary European science.

Thus, we find very modern comprehension of science in the elements of the work of the Pythagoreans and Plato's other circles; but, we also meet commonplace aspects of customary modern science instruction which are cruder than the thinking of the best among the Classical ancients.

On the subject of the crucial issue so posed as an included effect of that gap, there is the particular case posed immediately by the referenced trio of Nobel supplicants; the key question to be asked on that account here, may be fairly stated as: "What do we mean by geometry?" We are obliged to skip directly, away from the implied mechanistic outlook of Euclidean geometry, to the dynamics of the ancient Pythagoreans, Plato, and of Bernhard Riemann's habilitation dissertation, in order to return to the relatively far more advanced, pre-Euclidean standpoint represented by the circles of the Pythagoreans and Plato.

---

8. Both Vernadsky and Einstein, respectively, and independently of one another, came to identify the competent modern scientific method as being Riemannian. In Einstein's account of this, the most essential of the accomplishments of Riemann, are a reflection of a scientific method traced systematically to the work of Johannes Kepler, who, in turn, traced his method to, principally, the founding of modern experimental-scientific method by Cardinal Nicholas of Cusa, with credit also given by Kepler to the developments by Cusa follower Leonardo da Vinci. Thus, once we have recognized the crucial role of Gottfried Leibniz in all of this, the essential core of modern physical science is rooted in the founding work of Kepler, who laid the foundation for such most notable successors as Fermat, Leibniz, Abraham Kästner, Gauss, Dirichlet, and Riemann. Riemann's discovery, as a follower of Kepler's original method, establishes that notion of physical geometry on which all competent modern science thereafter depends. Notably, Kepler has no rival in his originality as the founder of modern astrophysics; Copernicus and Brahe are useful, but only despite their failure to grasp the essential principle, that first discovered by Kepler, which establishes the potential of modern astrophysics as a true physical science.

FIGURE 1  
**Eratosthenes' Method of Measuring the Size of the Earth**

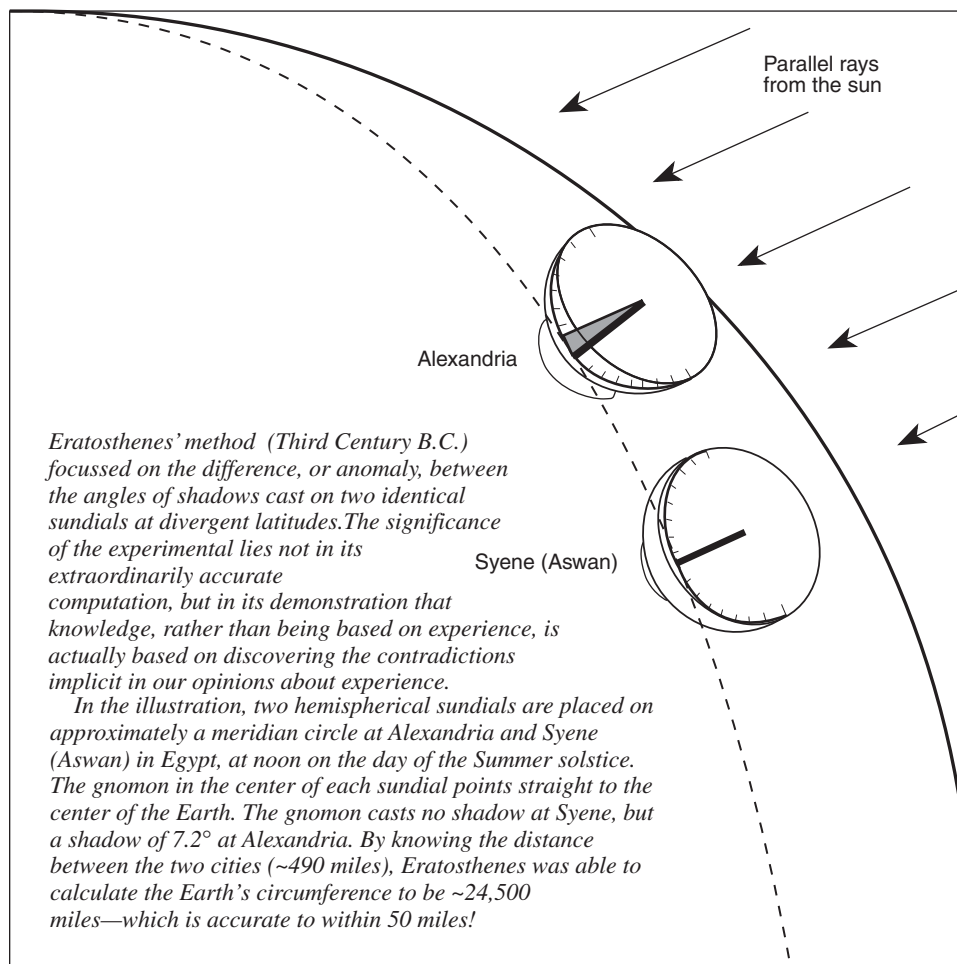

The related gap, on which our attention as modern economists must be concentrated here, is the historical gap between the time of the role of ancient *dynamics* in the physical-scientific method of the Pythagoreans and Plato, and the modern re-appearance of science in the work of our modern Cusa, Kepler, Leibniz, and Riemann,<sup>9</sup> and away from the simplistically reductionist, pathetic crudities of ancient radical reductionism echoed by that degenerate, radically positivist outgrowth of the Cartesian method of mechanics echoed by the three Nobel award-winners in the case presently at hand.

Look at somewhat parallel cases of net progress in science, that of the ancient Pythagoreans and the Platonic Academy, and the modern experimental science launched under the direction of Cusa. View this from the standpoint of geometry seen as a subject which should be considered a subsidiary feature of a notion of *physical astronomy*, as distinct from

9. The Classical Greek *dynamis*, which Leibniz restored to modern science as the principle of *dynamics*.

mere star-gazing. Look at *physical astronomy* from the standpoint of its role in ocean-going astrogation, as Eratosthenes' famous measurement of the great circle of the Earth reflects the methods of astrogation [Figure 1]. Think back to a time prior to the great glacial melt during about 17,000 to 2,000 B.C., an interval when ocean-going maritime cultures migrating in relatively large flotillas, preceded the gradual emergence of a land-based civilization within the northern regions of Eurasia and North America, as within the then crucially significant maritime cultures of the Indian Ocean, such as that which founded the non-Semitic, Sumerian, cuneiform culture of southern Iraq.

Relevant forms of traces of ancient "star maps" of our Zodiac, locate calendars based upon the span of multi-millennial cycles, producing thus those observed changes in the configuration of the heavenly bodies which must have been comprehended for ancient and later modes of trans-oceanic navigation. Applying the methods of astrogation used by na-

vies as recently as prior to some decades ago, we can rather readily adduce the kind of long-ranging maritime practices which produced the relevant ancient calendars. The task, then, is to see the Solar system as Johannes Kepler presents it: not as a simply spherical system of perpetual motion, but a developing process, a process in which ordered development is governed by what modern science, since Kepler, knows as invisible, but efficient, universal, anti-entropic physical principles.

It is the evidence, such as that emphasized by Kepler, that universal principles of astrophysics forcefully violate what might be otherwise presumed to be a simply spherical geometry, which supplies us the keys to beginning the discovery of our universe's actual, efficient forms of universal physical principles. Thus, we are obliged, as the ancient Pythagoreans had been, to shift from simple astronomy, to *physical astronomy*, to shift attention to effects which must be attributed to the action of universal physical principles upon the system of motions to be observed in the universe which envelops us. We proceed thus, from Kepler's emphasis on the needed de-



FIGURE 2

## Archytas' Construction for Doubling the Cube

Archytas developed a construction to find two geometric means between two magnitudes, AC and AB.

Magnitude AC is drawn as the diameter of circle ABC; AB is a chord of the circle. Using this circle as the base, generate a cylinder. The circle is then rotated 90° about AC, so it is perpendicular to the plane of circle ABC; it is then rotated about point A, to form a torus with nil diameter. (The intersection of the torus and the cylinder produces a curve of double curvature.) Chord AB is extended until it intersects

the perpendicular to AC at point D; this forms triangle ACD, which lies in plane of circle ABC, AB, and AC.

Triangle ACD is then rotated around AC, producing a cone. The cone, torus, and cylinder, all intersect at point P. Perpendicular PM is then dropped from P along the surface of the cylinder, until it intersects circle ABC at point M; this forms right triangle AMP.

Through this construction, a series of similar right triangles (only partially shown) is generated, which produces the

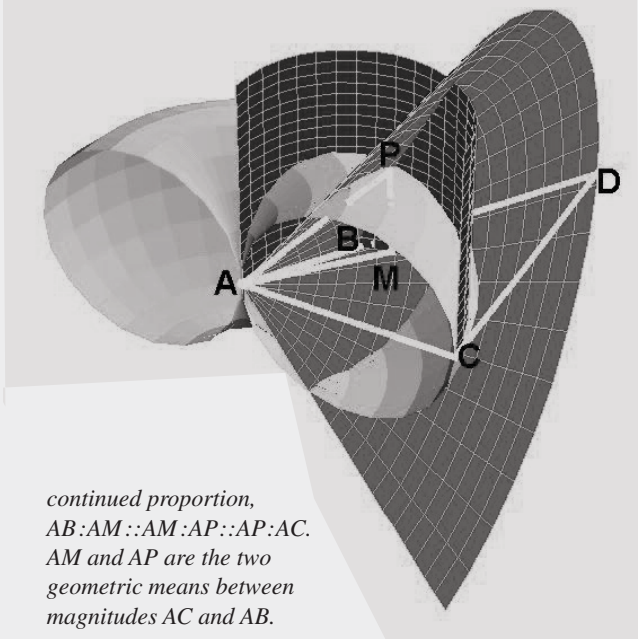

continued proportion,  $AB:AM::AM:AP::AP:AC$ . AM and AP are the two geometric means between magnitudes AC and AB.

velopment of the physics of elliptical functions, into the still higher, anti-entropic, physical hypergeometries of Riemannian physics.

Millennia prior to the uniquely original discoveries by Kepler and his students, cultures such as the Pythagoreans had, thus, already brought astrogation “down to Earth” in the form of a scientific practice known as *Sphaerics*. The principles of *Sphaerics*, as contrasted with the Sophist hoaxes associated with Euclid, are an extensive subject for study in themselves; for the purposes of this criticism of the referenced Nobel hoax, it is sufficient to emphasize such examples as both the celebrated, scientifically crucial, constructive doubling of the cube by Plato’s friend Archytas [Figure 2], and the underlying implications of the mastery of the design of the Platonic solids by Theaetetus. In fact, the crucial ironies posed to the future by the Classical Greeks’ work on this matter, were not understood systematically in modern European practice until the unique discoveries by Cusa, Kepler, et al.

The relevant point to be emphasized in this location, is that geometry does not pertain primarily to measurement of the Earth, but to measurements of the universe within which we are contained, which we experience as situating, and controlling the fate of our planet Earth. The birth of a true modern science begins with the recognition that that universe is not simply a repeating process, but is an expression of an open-ended, *specifically anti-entropic* quality of universal process of development of the universe from relatively simpler, to

more complex, higher-ordered processes.

In other words, we have thus entered the domain of astrophysics, which means the domain of mankind’s voluntary role, as specified in *Genesis 1*, in influencing the unavoidably continuing, qualitative development of (not merely our Solar System, but) the universe we inhabit. Johannes Kepler’s two, unique, closely interrelated, principal discoveries, of the physical principle of universal gravitation and its harmonic ordering of our Solar System, thus typify the modern meaning of physical geometry as the other, higher-ranking name for a modern, Riemannian mode in physical science.

Thus, all competent science, including a science of mankind’s increase of, or failure to increase his potential relative population-density, must be premised on a special notion of astrophysics (a less misleading name than “geometry”): a *physical geometry* adumbrated by the principles of ordered changes in the organization and related behavior of our universe. Competent economics must be defined, therefore, as the principles of either ordered increase, or failure to increase the power of the human individual will to make changes which improve the universe we inhabit for the benefit of mankind, that to the effect assigned to man and woman in *Genesis 1*.

It is directly relevant to the pathetic case of the Nobel award treated here, to emphasize that the systematic foundations of modern physical science were established by Cardinal Nicholas of Cusa’s recognition, that Archimedes’ proposed quadrature of the circle and parabola was incompetent,

that on grounds of physical principle. This was a fundamental discovery of principle, by Cusa, which was to become crucial for Kepler’s later, uniquely original discovery of the universal physical principle of gravitation. Here, formal geometry *per se* must be abandoned, to be replaced entirely by a hypergeometry of universal physical principles, as with Kepler’s uniquely original discovery of the physical principle of universal gravitation.

This was crucial, as Kepler was to emphasize, in locating physical science within the domain of a general theory of elliptical functions,<sup>10</sup> the same crucial evidence which prompted Kepler to enlist “future mathematicians” in the crafting of a universal calculus which would be accomplished, uniquely, by Gottfried Leibniz.

In that sense, there is no science but *physical geometry so conceived*, on the condition that we define geometry itself rightly, as Leibniz did so, *as physical geometry*, that in contrast to the subsequent perversions by D’Alembert, Euler, Lagrange, and Cauchy. Here, in terms of such a view of a physical geometry, a *dynamical, rather than mechanical* geometry, lies the crucial proof of the essential incompetence of the subject Nobel award.

So, implicitly, the very choice of language, the subject trio’s “mechanism design theory,” essentially, gives the folly of their show, and Henry Paulson’s, away.

---

## 2. Dynamics: Man in Our Universe

---

The key to competent economic science can be reduced rightly to the simple statement: *The human individual is not an animal.*

Conceded: the human individual has been awarded an animalistic body; nonetheless, there is a fundamental difference, a difference of fundamental principle, between the role of man in nature and that of any merely animal species. Formally, the difference may be measured as an *ecological* paradox, which may be summarized as follows.

All forms of life are subject, as a set of species, to *dynamical* regulation of a *potential relative population-density, per capita, and per square kilometer of surface-area*. This is a potential which is built into the set of interacting species, *dy-*



White House photo/Shealah Craighead

*Treasury Secretary Henry Paulson (shown here when President Bush announced his nomination on May 30, 2006), appears to have learned nothing crucial from the collapse of the LTCM hedge fund in 1998. He and our Nobel Prize winners are to be condemned “for being madmen running amok spreading an awful disease.”*

*namically*, in the sense of Leibniz’s *Specimen Dynamicum*. Only man, as *Genesis* 1 states, is capable of *willfully* changing that functional characteristic of his own, and also other species *in principle*. Man does not act as another animal within the set of animal life; man is distinguished from the set of the beasts by those of his actions, as from a higher plane—a higher order of universal physical phase-space, which, typically, transforms the ecological potential among the set of the affected animals.<sup>11</sup>

Thus, we may say, that the human individual soul is implicitly, efficiently immortal, and, in this degree, is ultimately become independent of the animal-like body it had once, temporarily, inhabited: the effects of changes introduced to the principled form of human practice, changes which may be supplied to society by the willful action of a single, sovereign human individual, are able to continue to supply an efficient increase in *the relative potential population-density* of the human species for generations to come, for a time far beyond the mortal death of that individual human body which had conveyed the relevant principle of development into action. The advantage to mankind of the discovery and propagation of a known, valid universal physical principle, is an example of this.

This willful distinction of the human individual mind from that of the beast, defines a distinction of human nature, as a universal phase-space, as precise as that which, compara-

---

10. From the work to this effect by Gauss et al., and by Riemann’s subsequent treatment of Abelian functions and hypergeometries.

---

11. V.I. Vernadsky’s *Noösphere*.

bly, separates living organisms in general, dynamically, from non-living processes.<sup>12</sup> The notion of the existence of such a distinction between living and non-living processes, is presented to us, in functional terms of reference, by the example of Kepler's uniquely original discovery of universal gravitation. Similarly, mankind's ability to escape those bounds of a relatively fixed potential relative population-density, which are relevant for a lower form of life, represents the existence of a universal physical principle, a characteristic of the nature of the human individual, which does not appear in any lower form of life.

From the comparative standpoint of animal ecology, mankind embodies, thus, a characteristic, *noëtic* principle absent in all lower forms of life. This principle is the only true expression of specifically human creativity. It is a principle excluded from modern *Liberal* styles (such as empiricism and positivism) in contemporary classrooms. It is this *noëtic* principle in human cognitive behavior, which enabled Kepler to recognize the dynamic principle ordering the planetary orbits, and to adduce a general principle of Solar gravitation from the evidence of the harmonics of the complex of planetary orbits. This same *noëtic* principle, as a characteristic of those creative potentials of the individual human mind which separate the human species from the mere beasts, is also the underlying principle of the Leibniz calculus. That principle, as prescribed, together with the development of the general principles of elliptical functions, as proposed by Kepler, underlies the Leibniz-Bernouilli definition of the catenary-cued, *universal physical principle of least action*.<sup>13</sup>

The effect of the active presence of that distinguishing principle of individual human existence, is normally expressed as an increase in the relative population density, of the human species per capita and per square kilometer. This is also expressed, as by Vernadsky, in terms of shifts in the relative composition of the component masses of the planet, in terms of the shifting percentiles of the total mass of our planet associated, respectively, with the inanimate element, with the Biosphere, and with the Noosphere: such that, under successful condition of practice, the Biosphere increases, cumulatively, as a percentile of the total mass of the planet, and that the Noosphere normally increases in mass, *and rate of increase of mass*, relative to the Biosphere.

The changes in ratios among the three, pertain to the expansion of the boundaries of effective action of each of the three (respectively non-living, living, and cognitive) domains. As society extends the reach of its effective such action into the micro-sphere and the macro-sphere, man's efficiency of existence is increased per capita and per square kilometer of

the Earth's surface.<sup>14</sup>

Measurements of such phenomena of changed relative powers among domains, can not be measured in mechanical (e.g., Cartesian) terms; they must be measured in terms of *dynamics*, as Leibniz defined *dynamics*, relative to Cartesian folly.<sup>15</sup> *The thesis of the three beneficiaries of the referenced Nobel prize, is, therefore, intrinsically folly on that account alone. However, that is only the relatively superficial aspect of the trio's incompetence.*

## The ABCs of Bio-Dynamics

All who are versed in the modern profession of animal ecology, are familiar with the problem of *temporary* increases in relative potential population-density of an animal, or other non-human living species. (For example: an increase in the population of rabbits above the relevant "average" ecological potential, may appear to benefit families of hungry foxes, as also extroverted house-cats, in the short run; but, that sets countervailing effects into motion, such that, in the end, the gains of both species prove to be no better than temporary.)

Animal ecologists are also familiar with shifts in climate and other so-called "natural conditions" in the "environment," changes in conditions which alter the potential level of stability of an eco-system. Thus, the term "relative potential population-density" is a well-established notion among competent naturalists generally, and of relevant biologists otherwise. With the introduction of the subject of the behavior of the human species to that investigation, the meaning of "ecology," and of the associated notion of "potential relative population-density," must be radically changed: human "ecology" is not a branch of "animal ecology." Only incompetents would discuss matters of human ecology in the same terms used for discussion of animal ecologies.

The increase of populations (e.g., "potential relative population-density") of human societies, presents us with a phenomenon which is not met within the animal kingdom. Man is not an animal; the distinction of human "ecology" from all animal ecology, is comparable to the distinction between the chemistries of non-living versus both the living processes and the by-products specific to living processes.

These distinguishing bio-chemical changes in the "ecology" of the human species, have been the special province of Russia's V.I. Vernadsky and his associates. The concept of the "Noosphere" is a result.

As far as I know to date, the effective treatment of this distinction of human "potential relative population-densities" from animal varieties, has been among my unique contribu-

12. Cf. Lyndon H. LaRouche, Jr. "Vernadsky & Dirichlet's Principle," *EIR*, June 3, 2005.

13. This was Leibniz's notion of what Gauss was to recognize openly, later, in updating his work on the Fundamental Theorem of Algebra, as the Leibniz-Bernouilli basis for defining a physical complex domain.

14. Cf. Riemann, op. cit., §3. op. cit. pp. 285-286. Wherein the three prize-winning Nobel cases should have noted: "... *Es führt dies hinüber in das Gebiet einer andern Wissenschaft, in das Gebiet der Physik, welches wohl die Natur der heutigen Veranlassung nicht zu betreten erlaubt.*" Mechanics, a derivative of aprioristic arithmetic, is not physical science.

15. E.g., Gottfried Leibniz, *Specimen Dynamicum* (1695).

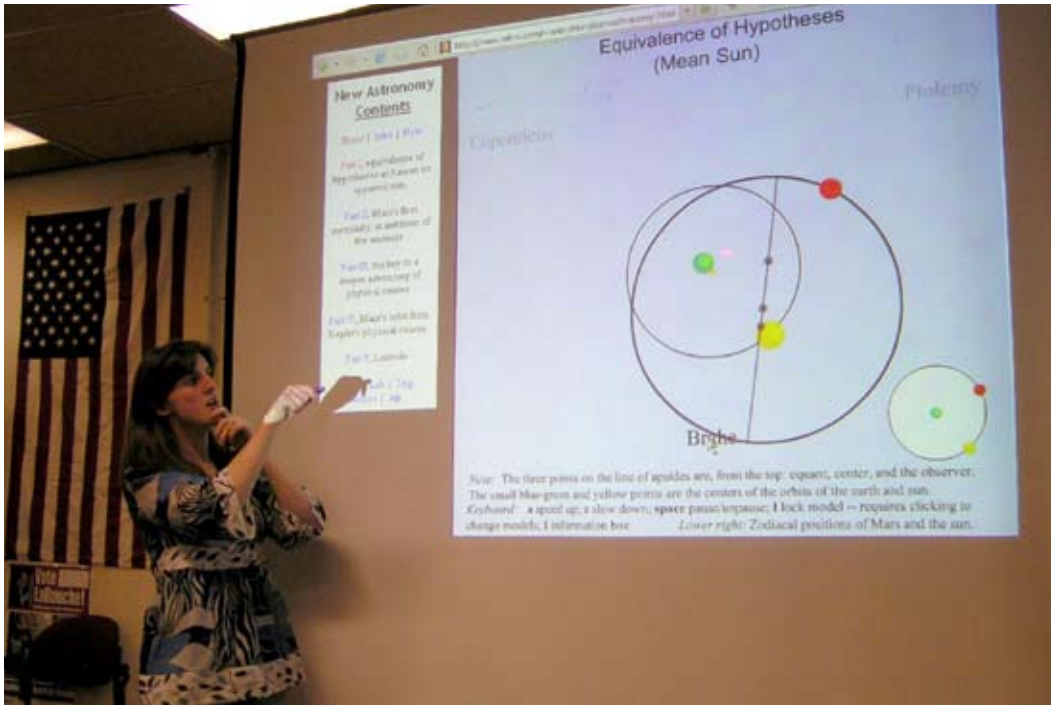

EIRNS/Aaron Isherwood

*The rigorous work on Kepler by the LaRouche Youth Movement's "Basement Teams" in Northern Virginia, is now radiating out to LYM operations worldwide, including the class here in Melbourne, Australia.*

tions to the science of physical economy and of successful long-range economic forecasting generally.

The functional relations between ordinary non-life and life, on the one side, and mankind on the other, can not be treated as the members of the Nobel trio do, and are not representable in mechanical terms, such as those of a Cartesian system. Here lies the crucial evidence of the essential absurdity of the very proposition which the Nobel Committee reported on this matter. In all competent science, it is the relationships among principles, rather than among discrete objects pummeling one another in empty algebraic space, which determines the characteristic behavior of the relevant systems.

The commonplace problem, as in the case of summary argument presented by Hurwicz et al., is that the usual way in which mathematics is taught and learned, relies on mathematical formulations which describe the relevant events in a mechanical-mathematical way. On this account, modern taught mathematics practice commonly falls way below the intellectual standards of the ancient Pythagoreans and Platonists; reductionist methods, such as those of Sarpian empiricism, degrade mathematical arguments into a superficial describing of nature, rather than insight into the fact that what appear to the experimentalist as mechanical-like interactions, are actual reflections of the interaction of the principles representing two or more distinct systems.

For example: in the case of interaction of living species, man's essential form of *functional* (e.g., ecological) relationship to the beasts is not individual man to beast, but the interaction of the distinguishing, noëtic principle of mankind with the non-noëtic characteristics of lower forms of life. How

does man, for example, induce qualitative changes in the systemic ecological potential among the beasts?

Comparably, when society introduces the application of a newly employed discovery of a universal physical principle to even a portion of a nation, or of human society as a whole, this principle, itself, transforms the social-economic relations within society as a whole in a way which then becomes characteristic of that society as a whole. So, the adoption of the policy that nuclear power's application shall be the dominant technology in society, imbues all parts of that society, whether they use nuclear technologies locally, or not, with the characteristics of a system of society which depends for its existence, and the characteristics of its existence, on the implications of applied nuclear fission.

That, briefly, is an elementary sort of illustration of the meaning of *dynamics*, rather than mechanics, in defining the characteristics of those human ecological processes we know as economies. That is the essential difference between a competent science, such as that of Leibnizian dynamics, and the intrinsic incompetence of the reductionist Descartes and his followers, such as the three Nobel prize-winners. Such is the incompetence of the mechanistic method underlying the failures inherent in linear programming, for example.<sup>16</sup>

Another way of representing the same kind of distinction, is to say that all linear programming is intrinsically incompetent as a means for defining the effects of technological

16. This was the problematic feature, the intrinsic, systemic error of mechanistic schemes of economic accounting and forecast, left unresolved by Wasily Leontieff et al.

change, or lack of change, on an economy. All competent representation of social-economic processes is intrinsically a matter of the Riemannian hypergeometries required to describe an actually dynamic universal system.

Dynamics appears in the study of economic processes as a matter of hypergeometries. It is the introduction of the changes generated by use of a discovered, new universal physical principle, or revival of an abandoned such principle, which transforms all of the “set” of relations within the unified processes to such effects as a qualitative upshift in net potential relative population-density of an entire society, as by so singular a change as the introduction of general use of nuclear-fission technology to supersede modes of a qualitatively inferior “energy-flux density.”

It is not the number of calories supplied which determines productivity, but the relative energy-flux density of the mode of power supplied. The use of raw “solar power” for raw power will degrade, and, thus, ultimately, destroy a culture; whereas, the use of “solar radiation” for production of food and forests, will lower the mean temperature relatively, while increasing the relative potential population-density of that society as a whole. So, the primary moral use of hydroelectric systems is not to be seen as a general source of power, but functions of water management which increase the conversion of Solar radiation into water for life, and also produce some useful power as a by-product of this arrangement.

# America's Untold Story

How the trans-Atlantic republican movement waged a continuous fight for freedom, beginning with John Winthrop's Massachusetts Bay Colony in 1630.

\$19.95

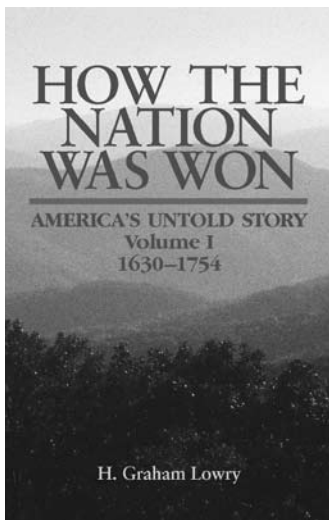

ORDER FROM  
**EIR News Service, Inc.**  
 P.O. Box 17390  
 Washington, D.C.  
 20041-0390

Order by phone, **1-800-278-3135**

**OR** order online at [www.larouchepub.com](http://www.larouchepub.com)

Shipping and handling: Add \$4 for the first book and \$1.00 for each additional book. Virginia residents add 4.5% sales tax. We accept MasterCard and Visa

The essence of the matter, is that mankind's specifically human *noëtic* power, as identified by the generation of discovery of valid universal principles, is the essential principle of action (of both ancient Greek and modern *dynamics*) which expresses the functional relationship between mankind (i.e., society) and lower forms of life, and also non-life. It is dynamics, so defined—Riemannian *dynamics*, as identified by Vernadsky and Einstein respectively (instead of any mechanical design), which pre-determines successful actual evolution within national and world economies.

## The Fallacy of Sense-Perception

In my “Music & Statecraft,”<sup>17</sup> I emphasized the point, that human knowledge of the real universe outside our skins, is not imparted to us as literal readings of sense-perceptions as such. Rather, as I employed the case of Helen Keller to illustrate the point in that location, our knowledge of the universe is not imparted to us in the form of simple sense-perceptions. Our actual knowledge of the universe, “as if outside our skins,” is the work of the specifically creative powers of human mind itself, a mind which treats all sense-perceptions in the fashion we should regard the “information” supplied to us by laboratory instruments. The most important of these ironical facts, is the case of knowledge, such as Kepler's discovery of the harmonic organization of the Solar System, which depends on the mind's “decoding” of the ironies of (for example) sight and hearing. Our use of instruments to enable us to probe domains into which unaided sense-perception may not reach, into the sub-atomic small and the astrophysical domain of action on a vast scale over enormous lapses of time, underscores the point made by Riemann in the concluding §3 of his 1854 habilitation piece.

It is not sense-perception as such which provides us knowledge of the real universe in which we live; it is the power of the human mind to provide the human individual with a reading of the instruments called our “senses,” to an effect produced, not by mere sense-phenomena, but by those powers of the human mind which do not exist among the lower forms of life.

For example:

Until Twentieth-Century developments, specifically Vernadsky's and Einstein's adoption of Riemannian physical geometry, we were accustomed, at best approximation, to think of a universe representing a single quality of space. Einstein brought us to think of physical space as a gravitational model of a *finitely self-bounded*, Riemannian physical space-time. Vernadsky proved that our presently known universe is composed of three, interlocking phase-spaces: non-living, living, and cognitively *noëtic*.

We dare not, now, presume that that is the limit of such discoveries of complexities of our universe. However, we

17. Lyndon H. LaRouche, Jr. “Music & Statecraft: How Space Is Organized,” *EIR*, Sept. 14, 2007.

may be certain, that within those bounds, the way of thinking about the universe which we have obtained with the help of Vernadsky and Einstein, is functionally correct for all ordinary purposes of practice today, at least relatively the best available to us presently.

For our purposes in this report, it is sufficient to emphasize that the three physical phase-spaces of Vernadsky are what we should understand here as interacting. That is, that the universal principle of life as such, including chemical materials produced by action of life, acts, in turn, on both the non-living domain, as it acts also on the intellectual-noëtic domain, and as the applied discoveries of noëtic scientific practice act upon both the Biosphere and the more primitive domain.

In effect, each such quality of physical space-time acts to shape the conditions of action within the other two, just as human cultural activity shapes the existence of living species according to the broad implications of Leibniz's 1695 *Specimen Dynamicum* and his and Bernoulli's universal principle of physical least-action.

*The almost most notable fact in this latter array, is the evidence that the noëtic powers of the human individual are superior historically to both the Biosphere and the non-living domain. The actually most notable fact, is that the entire system is implicitly subsumed by the specific noëtic powers of the individual creative mind's discovery of principles and their use (the Noösphere). Man is thus to be seen as made in the likeness of the Creator, including the matter of the power of the will to create.*

*That principled potential of this unique quality of action of the mind of the human individual, is the fundamental principle underlying all competent practice of economics as a physical science.* Whereas, the subject Nobel trio dwells in a kind of childish fantasy associated with the board-game called "Monopoly."

We must learn to employ the notion of human ecology, as qualitatively distinct from animal ecology, with those considerations in view.

It should be clear from what I have reported thus far, that we must not take the popular, naïve view of universal space-time literally. The relevant LaRouche Youth Movement (LYM) teams spent a good deal of effort in producing a rigorous showing of the way in which modern European civilization arrived at Johannes Kepler's insight into the functional (dynamical) composition of the Solar System.<sup>18</sup> In due course, the student must give up the desire to simply see the organization of the Solar System as by "looking over the fence." Our sensing of the functional organization of the Solar System itself, must ultimately surrender to the reality that the universe is, as Einstein insisted, functionally self-bounded in a way which defines it functionally as "finite" in the sense of the us-

18. See the account of this within *The Harmony of the World* in *LYM: Animating Creativity*, under links in the LaRouche PAC website.

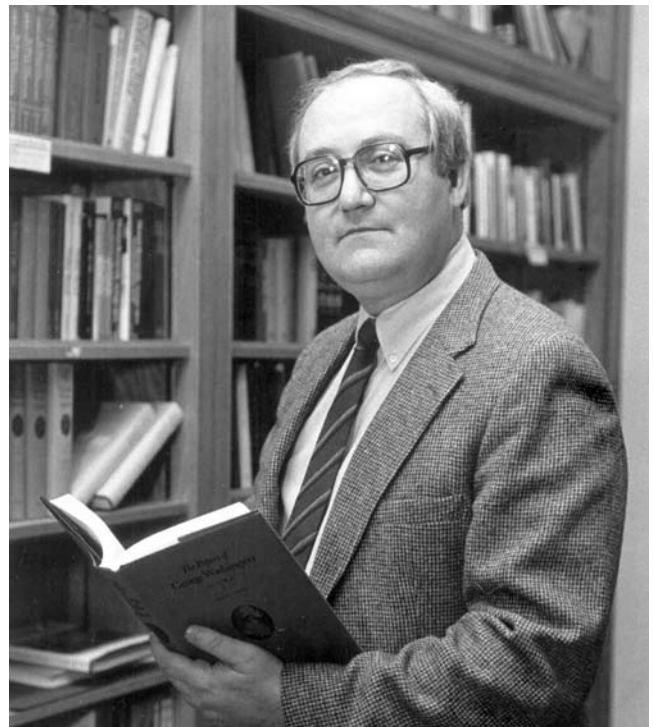

EIRNS/Stuart Lewis

*This report is dedicated to the memory of H. Graham Lowry, whose groundbreaking work on the American System "places him in the spirit of leaders of The Society of the Cincinnati such as Alexander Hamilton, Edgar Allan Poe, and James Fenimore Cooper."*

ages of Kepler, Riemann, Einstein, and Vernadsky. All notions of a universe extended into the Euclidean and related form of delusion called mathematical "infinity," must be abandoned; the universe is known to sane and competent minds as a *dynamic* system in the Riemannian sense adopted by Vernadsky and Einstein, and in no other way.

---

### 3. The Matter of Liberalism

---

In the next, and final chapter, I shall focus attention on the actual role of money and pricing required for a healthy, non-mechanistic form of design for a rebuilt U.S. (and international) economy. The objective shall be, as it had been Franklin Roosevelt's intention for the post-war world, a world system composed of cooperation among respectively sovereign nation-states. In that chapter, I shall summarize the physical principles to be adopted as the alternative to the deadly lunacy of the scheme outlined by the referenced three Nobel prize recipients.

As preparation for that concluding argument, we focus now on the issue of the global heritage implicit in the role and intention of President Franklin Roosevelt.

To understand the roots of the folly of the subject Nobel award, I must once again, as in earlier publications, turn your

FIGURE 3

## The Collapse Reaches a Critical Point of Instability

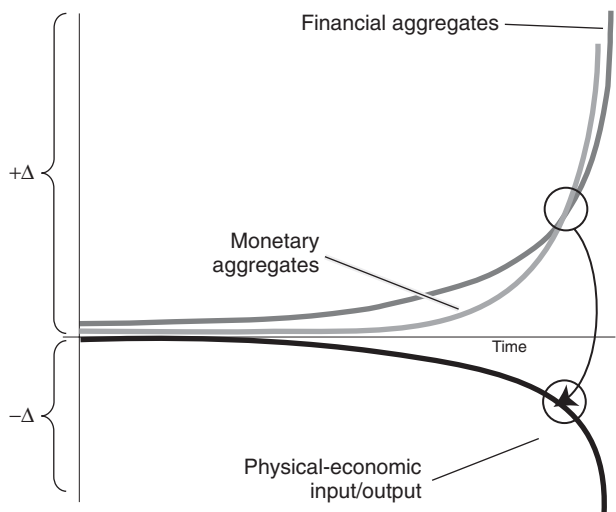

attention to the relevant issues posed by the founding of what was to become known as those modern doctrines of political-economy associated with Anglo-Dutch Liberalism. In the foregoing sections of this report, I have already emphasized the role of the notion called *dynamics* in defining the anti-Liberal, scientific policies of practice on which the singular achievements of the U.S. republic and its economy have depended—whenever we chose to return to them, as we must do so now. Our currently monstrous economic folly as a nation, begs for a defense of those principles on which our republic’s successes have depended, and a rejection of a return to the Anglo-Dutch Liberal principles against whose evils, of such as Adam Smith and the treasonous British East India Company scoundrels among us, against which our republic’s struggle for freedom was conducted.<sup>19</sup>

The foregoing treatment of the science of economy has brought our discussion, now, nearly to a state of preparedness for treating the subject of money and prices. To prepare for the subsequent introduction of that subject-matter, I refer the reader’s attention now to a pedagogical diagram which I have used, more or less regularly, since January 1996, when I introduced it as the thematic feature of my campaign for the U.S. 1996 Democratic Presidential nomination [Figure 3]. In that location in the concluding chapter of this report, I shall repeat

19. In that sense, this present report is dedicated to the memory of the American historian and patriot H. Graham Lowry whose *How the Nation Was Won* (Washington, D.C.: Executive Intelligence Review, 1987) places him in the spirit of leaders of The Society of the Cincinnati such as Alexander Hamilton, Edgar Allan Poe, and James Fenimore Cooper.

the updated version which I presented first for my campaign for the Democratic 2000 Presidential nomination. I shall discuss the practical implications of that illustration at a suitable point in the subsequent, concluding chapter of this report.

Now, in this present chapter, I prepare the way for that specific element of the discussion.

As that accompanying diagram illustrates, not only do I seem to have the makings of a celebrated major prophet of our times; the general effect of the radical changes in U.S. economic and financial policies which occurred, and which I denounced during the interval from 1967-68 to 1981, produced what has become a decades-long, net decline in both the real, U.S. physical-economic output per capita and per square kilometer of our territory, with an accompanying upward acceleration in relative prices and financial indebtedness. That physical decadence, and rising financial indebtednesses of our own economy and those of the Americas and of western and central Europe, has been the predominant trend in the world economy at large, since approximately 1968, up to the present point of the general collapse triggered by insanely belligerent strategic U.S. policies toward China, policies which were crucial in unleashing that immediate, currently ongoing great crisis which struck world markets during the month of July 2007 and beyond.

It is probably necessary to state the fact, here, that had our U.S. Government and the Democratic Party leaders heeded my now thoroughly vindicated warnings, even as recently as early 2006, the present global disaster hitting the U.S. and world economies could have been avoided. They did not do so, and the consequences now being suffered by our nation as a whole, are the result.

The diagram shown here, while schematic, contains nothing misleading in respect to what it purports to represent as the general trend being considered here. In this present chapter of the report, we shall supply the needed background for the following chapter’s discussion of the matter which that diagram illustrates.

Now, consider a few urgent bits of recent economic history, on background.

### The FDR System

Had President Franklin Roosevelt not been inaugurated in March 1933, Adolf Hitler and his successors almost certainly would have been coming to rule and ruin the world from that time to the present. The world situation today can be seen as a fair approximation of those pre-Franklin Roosevelt, 1920s developments which had plunged the world into the great Depression of the 1930s. Today, the new monetary system which emerged under FDR, which then made us prosperous and powerful for two decades to come, was a period of increasing, and relatively great prosperity, one which FDR had led in crafting; but, now, over the most recent three decades, that accomplishment has been destroyed by an orgy of “free trade” which has now become far worse than any economic recess-



FDR Library

*The successful world monetary system which emerged under President Franklin D. Roosevelt has now been dismantled, and "we are presently at the end of our rope," writes LaRouche.*

sion already experienced during the 1920s and early 1930s. We are presently at the end of our rope, by which our nation's fate will be surely hung, unless we now, very suddenly, abandon the whisperings of that contemporary "Mr. Scratch," Felix Rohatyn, and his like, that we might now change our ways back in the direction of what FDR had done from 1933 onward.<sup>20</sup>

During the close of the 1920s and first half of the 1930s, the leading "American Tory" circle of Manhattan, descendants of Vice-President Aaron Burr and Liberal President Martin van Buren, as these were merely typified by Brown Brothers Harriman, were fully committed to support the then-head of the Bank of England, Montagu Norman, in bringing Hitler's system to world power. Franklin Roosevelt's actions

20. "Mr. Scratch" refers to the Satan of author Stephen Vincent Benet's celebrated short story, "The Devil and Daniel Webster," a Satan whose present-day real-life incarnation would be, most appropriately, the notorious Middlebury College monster, Rohatyn.

in his role as President prevented that evil bankers' plot from succeeding, and even turned many of the former Hitler backers of Manhattan, such as the Harriman interests (including our current U.S. President's grandfather), to becoming supporters of Roosevelt's great global alliance against Hitlerism.

The Manhattan and London financier crowd used the opportunity of President Roosevelt's untimely death, to reverse some of the most crucial of Franklin Roosevelt's anti-Hitler reforms. With the assassination of President John F. Kennedy on November 22, 1963, our U.S. was plunged into the waves of folly which have destroyed the structures of prosperity we in the U.S.A. had enjoyed until that time. With the riotous international developments of 1968, the way was cleared for uprooting the great prosperity which the U.S.A., and much of Europe, had enjoyed in the aftermath of FDR's social, physical-economic, and monetary reforms.

Unless we now change back into an FDR direction, and that dramatically, this nation of ours, among others, will not survive much longer, perhaps even not until January 2009. Even worse, if we go down, the world as a whole will go down in the aftermath of our self-destruction.

Such is the seriousness of the implications of the silliness of the crew, both former Vice-President Al Gore and the trio considered here, which has received the recent Nobel awards.

### **Charlemagne, Cusa & Louis XI**

Since the fall of the Roman Empire, there have been three principal revolutionary developments which laid the foundations upon which the founding of our U.S. republic has been premised. The first step toward a modern European economy was expressed as the great system of reforms under France's Charlemagne. Unfortunately, following Charlemagne's death, the Venetian financier oligarchy used sundry devices, including the launching of the series of Crusades, to ruin Charlemagne's reforms as much as possible; nonetheless, like the Cathedral of Chartres and the canal system which Charlemagne designed and launched for Europe, it was revived through elements of Charlemagne's program which were employed in the launching of the first modern sovereign nation-state of modern Europe, Louis XI's France, which was the model for Henry VII's reformed England.

However, the principles upon which all of the relative successes of modern European civilization itself have depended, was chiefly the work of Cardinal Nicholas of Cusa, the founder of the conception of the modern sovereign nation-state (*Concordantia Catholica*) and modern experimental science (e.g., *De Docta Ignorantia*). Louis XI's reforms were, like the discoveries of Christopher Columbus which Cusa's writings prescribed, chiefly an immediate reflection of the principled initiatives of Cusa's founding of the conception of the modern, science-based, sovereign nation-state.

The key to modern civilization has been Cusa's revolution, including his launching of modern physical science. Al-



though the formal institution of a modern physical science of *dynamics* was introduced by Leibniz during 1692-95, the actual revival of the ancient Classical Greek physical science of dynamics (*dynamis*) was made, earlier, by Cusa, as in *De Docta Ignorantia*, a work whose content was the basis employed by Kepler for his unique founding of a modern physical science of astronomy.

Initially, the reforms associated with the great ecumenical Council of Florence, in which Cusa contributed a key role, had defined the intended design of a modern form of technologically progressive, sovereign nation-state, such as that of France's Louis XI and, later, Henry VII's and Sir Thomas More's England. However, the spread of the Inquisition, as organized by the Venetian financier oligarchy's infamous Tomás de Torquemada, has divided European civilization since the 1492 expulsion of Jews from Spain, to the present day. The history of European civilization (and beyond) since 1492 has been a see-saw battle between principally two opposing forces within that portion of the Eurasian continent. This has been a conflict between the legacy of Charlemagne and the 1439 great ecumenical Council of Florence, on the one side, and the Renaissance's two, rival adversaries of that Renaissance, the two Venetian oligarchical factions, "antique, traditional (Aristotle)" and old Venice's Liberal (William of Ockham) rival, on the other.

Since the February 1763 Peace of Paris, when the Brit-

ish East India Company was established as an empire-in-fact, to the present date, the principal conflict within all globally extended modern European civilization, has been a struggle of the principles of the constitutional sovereign nation-state, such as that of the U.S.A., against the de facto, global, imperial financier-oligarchical power of the Anglo-Dutch Liberal financier system. Since the 1812-1815 (notably sexual) Congress of Metternich's Vienna, only the American Revolution has been a perpetually menaced, temporarily successful challenge to the supremacy of the Anglo-Dutch Liberal tyranny.

In these pages of modern history since, the victory of President Lincoln's U.S.A., against London's Lord Palmerston, and the legacy of President Franklin Roosevelt, have been notably successful challenges to imperial world domination by the Anglo-Dutch Liberal system. During most of the time since 1789, especially since President Lincoln's victory over Palmerston's treasonous American puppets, the Confederacy, and most notably since the accession of President Franklin Roosevelt, the British empire's challenge has been expressed chiefly by London's efforts to degrade the U.S. republic into a lackey of the Anglo-Dutch Liberal "free trade" system. This was done afresh, in the aftermath of the assassination of President John F. Kennedy, with the launching of the ruinous, fraudulently crafted, long U.S. war in Indo-China, a ruinous enterprise which led to the election of the U.S. President and scoundrel Richard M. Nixon, and the systemic wrecking of the U.S. constitutional system and economy over the course of the 1970s and beyond.

To understand the Presidency of Franklin D. Roosevelt, we must understand two things. First, that President Franklin Roosevelt's actions as President reflected his understanding of the patriotic legacy which his ancestor, Isaac Roosevelt, had shared with former U.S. Treasury Secretary Alexander Hamilton. Second, that all great, principled endeavors, especially those in public affairs, emerge as expressed approximations of the intention which had motivated them.<sup>21</sup> Neither the original U.S. republic, nor Franklin Roosevelt's administration leaped fully formed from the brow of Athena; like a successfully fertilized germ-cell, the development of the germ of the maturing form of the original, principled intention, unfolds in interplay of its development with its environment. The quality of that interplay is never mechanistic, but *dynam-ic*. That intention was expressed by the insertion of the crucial statement of principle, "the pursuit of happiness," taken from

21. The notable enemy of the U.S. constitutional system of economy was the network of the London-directed, "American Tory" faction directed from 1763 onward by the British East India Company of Lord Shelburne. These treasonous "American Tories" were typified by an agent, Aaron Burr, of British Foreign Office "secret committee" head Jeremy Bentham. Bentham and Burr gave to the U.S. Presidents (and scoundrels) Andrew Jackson (of "The Trail of Tears" notoriety, and Jackson's owner, Land Bank swindler Martin van Buren. The Confederacy itself was a British creation of Bentham and Bentham's prize pupil, Lord Palmerston.

## Toward a New Council of Florence

### 'On the Peace of Faith' and Other Works by Nicolaus of Cusa

Translations of seminal writings of the 15th-century Roman Catholic Cardinal Nicolaus of Cusa, who, through his work and writings, contributed more than anyone else to the launching of the European Golden Renaissance. The title of the book, *Toward a New Council of Florence*, expresses our purpose in publishing it: to spark a new Renaissance today.

- 12 works published for the first time in English
- New translations of 3 important works

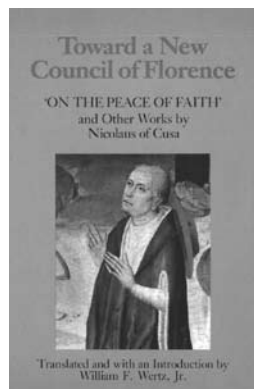

\$15

plus \$3.50 shipping and handling

**Schiller Institute, Inc.**

P.O. Box 20244 Washington, D.C. 20041-0244  
phone: 703-771-8390 www.schillerinstitute.org



*The flag of the British East India Company (left) and the Confederacy's battle flag, the "Stars and Bars." Both institutions were sworn enemies of the American System of political-economy.*

1689 has been Anglo-Dutch Liberal forms of rapine and imperialism. That remains our republic's chief, and perpetual adversary to the present day, not because the people of the United Kingdom are evil, but because they are themselves the victim of a neo-Venetian, usurious imperialist scheme which has menaced us of the U.S.A. since, especially, that February 1763 Peace of

Gottfried Leibniz's second rebuttal of John Locke, and the recapitulation of that same principle from the Declaration of Independence as the supreme principle of constitutional law expressed as the Preamble ("The General Welfare") of the U.S. Federal Constitution.

Paris which established Lord Shelburne's imperial British East India Company, whose first and foremost colony was Britain itself.

It is that evil system which the three subject recipients of the current Nobel prize represent, wittingly, or otherwise.

### On the Matter of War

War was never to be considered as a permanent principle of civilized society. The essence of relevant constitutional law is what is expressed by the 1648 Peace of Westphalia ("the benefit of the other"). War is never justified except as necessary defense of a society struggling to become a representative of the inherent natural, peaceful interest of the person as an immortal being in his or her soul, against the aggression by forces of evil. This means, typically, against those forces which like the Roman, Byzantine, Venetian-Crusader, or British empires, have a consuming, anti-humanistic appetite for tyranny over their intended victims.

Nonetheless, since history shows that almost anyone can be induced to become an enemy, war is never justified by the mere presumption that an enemy exists as a potential adversary. As the Peace of Westphalia, when considered in the context of long religious warfare, illustrates the case, it is insane to overlook that the object of the civilized nation is to make partners, if possible, where adversaries have stood, to win the other to a nobler cause through emphasis on the principle of "benefit to the other."

Human nature is not inherently evil except among people who believe that man is essentially evil. After seeing an aggressive crocodile, we know that, normally, man is essentially good. What we must recognize as evil in human beings is the quality of frankly pro-Satanic depravity of the type which, frankly, U.S. Vice-President Dick Cheney and his like represent, currently. There was never a reason to enter into the long, ruinous war in Indo-China, which became the means by which our republic became unraveled, nor the pro-Satanic policies of Samuel P. Huntington et al., policies, derived from British imperialist traditions, which sucked the U.S. into the ruinous, pit of warfare in Southwest Asia and beyond.

Our nation's only persisting enemy over the interval since

---

## 4. The Triple-Curve System

---

Turn now to the "Triple Curve" model presented in the preceding chapter.

Earlier, I have emphasized the fundamental difference between ecology, as that term can be applied to the domain of living processes below the quality of human behavior (the Biosphere), and the determination of those characteristics of human populations, and of human individuals, which separate human beings absolutely from all lower forms of life. That difference, I have emphasized, lies, functionally, in those creative mental powers specific to human individuals, powers which do not exist among lower forms of life. To restate that in broadly descriptive terms, the difference between man and beast is expressed as the function of the Leibniz differential of his calculus, or, the same thing, what Kepler discovered as the universal principle of gravitation, or what Nicholas of Cusa recognized as the crucial element of incompetence in Archimedes' attempted definition of the generation of the circle by quadrature.

This functional distinction of man from beast, was already known to the ancient Pythagoreans and Plato, although not to Aristotle, and certainly not to either William of Ockham, or Ockham's followers, the modern Liberals (empiricists). It is the form of action on the universe, by sovereign human individuals associated with those elements of practice of the Pythagoreans, Plato, Nicholas of Cusa, Kepler, Fermat, Leibniz, Gauss, and Riemann, but not the Aristoteleans, empiricists, et al., which are expressed in the role of human creativity in shaping the human species' ability to willfully increase its societies' potential relative population-density.

For example: Kepler's demonstration that the actually el-

liptical Earth orbit could not be generated mathematically by the method of quadrature used by Archimedes, defined the basis for the discovery of the principle of gravitation, as the higher-order, harmonic “anomalies” among the Solar System’s orbits defined the general principle of gravitation. This set of discoveries by Kepler was the basis for Kepler’s assigning the discovery of the Leibniz calculus to “future mathematicians,” and, also, the discovery of higher order considerations associated with the general role of elliptical functions in physical science (as distinct from the domain of naive textbook geometry).

In brief, then, the characteristic form of action which distinguishes the principle of population for the human species from the ecological models for lower forms of life, lies in mental actions of a type typified by the legacy of the “infinitesimal” principle of action from Kepler’s astronomy, as embodied in the work of such successors as Fermat, Leibniz, Bernouilli, Gauss, Abel, Dirichlet, and Riemann.

The complementary expression of this is found, despite the *New York Times* style book, in the *specifically ironical* role performed by the *comma* of Pythagoras and of traditional, literate forms of classical literary composition typical of European Classical poetry, prose, and musical composition during the Sixteenth through Eighteenth centuries, as suggested implicitly by William Empson’s *Seven Types of Ambiguity*.<sup>22</sup>

The role of increase of physically definable productivity specific to the sovereign individual human mind, represents the principle of action which not only defines the difference between the self-development of the human species and that of the inferior species of the entire animal kingdom, but is the entire basis for a rational study of the efficient physical principles of real-life economies.

Therefore, the essential characteristic of all competent attempts at a science of economy, is the need to define the observable elements of the social economic process (e.g., the economic system) in terms which reflect the active role of a form of human individual creativity which coincides with the function of the so-called “physical infinitesimal” of Kepler, Leibniz, Riemann, et al. in generating willful increase of the potential relative population-density within, or among societies.

Unfortunately, in the radically positivist econometric systems popular in universities and so forth today, there is no longer any effective comprehension of this crucial fact. The use of such currently popular, taught and practiced mathematical schemes as those latter, to define a “more perfect” approximation of a radically “free trade” monetarist design of a monetarist’s system, precludes, *axiomatically*, precisely those regulatory provisions on which the success of President Franklin Roosevelt’s revival of the constitutional American System’s general welfare principle depended.

22. (Middlesex: Penguin Books, 1961).

Read the Preamble of the U.S. Federal Constitution. Read it to the following effect.

## The Science in U.S. Constitutional Law

This brings our attention to the fundamental difference between U.S. constitutional law, and the law of all present legal and governmental systems of western and central Europe, in particular. European systems, especially all parliamentary forms of government, are intrinsically morally inferior to the U.S. constitutional system. The most flagrant expression of the relative moral and functional depravity pervasive among European systems, is met in the adoption of so-called “free trade” policies, under which governments are instructed to abstain from interfering with the free, self-regulated conduct of the European monetary systems.

Ironically, much European constitutional and other law, does echo the moral principle of the “common good,” the moral principle of the Apostle Paul’s *I Corinthians* 13; but other provisions of law and custom thwart this principle in moments of relevant crisis. This characteristic corruption of customary European parliamentary government, is rooted in the matter of the so-called “independence” of the monetary system’s central banking systems from government direction. The same parliamentary form of corruption is familiar to us in the U.S.A., and that with increasingly disastrous results, since the inauguration of U.S. President Richard Nixon.

This pervasive, monetarist form of moral corruption within the current systems of western and central Europe, is an echo of the very reason many European settlers moved to North America. The principles which they brought to North America, as in the case of the pre-1688 Massachusetts Bay Colony, were European; but, in Europe itself, that morality was systemically frustrated by the presence of the oligarchical traditions left over from feudalism and empires of the past.

The essence of the U.S. constitutional system, on this particular account, is reflected as constitutional law in the U.S. Declaration of Independence, as Leibniz’s “the pursuit of happiness.” The same principle is reformulated as the Preamble of the U.S. Federal Constitution. Under our patriotic law, there are two considerations which are absent from western and central European law and related practice today: first, that no currency or its like can be uttered except by the Federal Executive with the prior consent of the U.S. House of Representatives; second, that our constitutional principle of banking and credit defines the U.S. financial system as a credit system, rather than a monetary system. In other words, U.S. constitutional tradition rejects the notion that the state must be constrained by the monetary system, a role of monetary systems which our patriots have denounced and rejected as the evil practice of usury; and demands that all monetary systems be regulated by sovereign government.

Under the U.S. constitutional system, we require protectionist measures of regulation of credit and the currency system, which, through means such as differential rates of tax-

ation and other means of regulation, we create what has been called at times a “fair trade,” rather than “free trade” system.

The foregoing explanation delivered up to this point, the challenge to our government is to create a system of regulation in which the weighted adjustment of credit, taxation, and price reflected in the system of circulation of credit and currency, and of crafted schemes for taxation, such that the behavior of money and prices in circulation within our economy, and abroad, efficiently reflects those policy objectives implicit in the Preamble of our Federal Constitution.

That much said on background, we are now prepared to examine the implications of the “Triple Curve.”



*After seeing an aggressive crocodile, we know that, normally, man is essentially good. Vice President Cheney is a notable exception.*

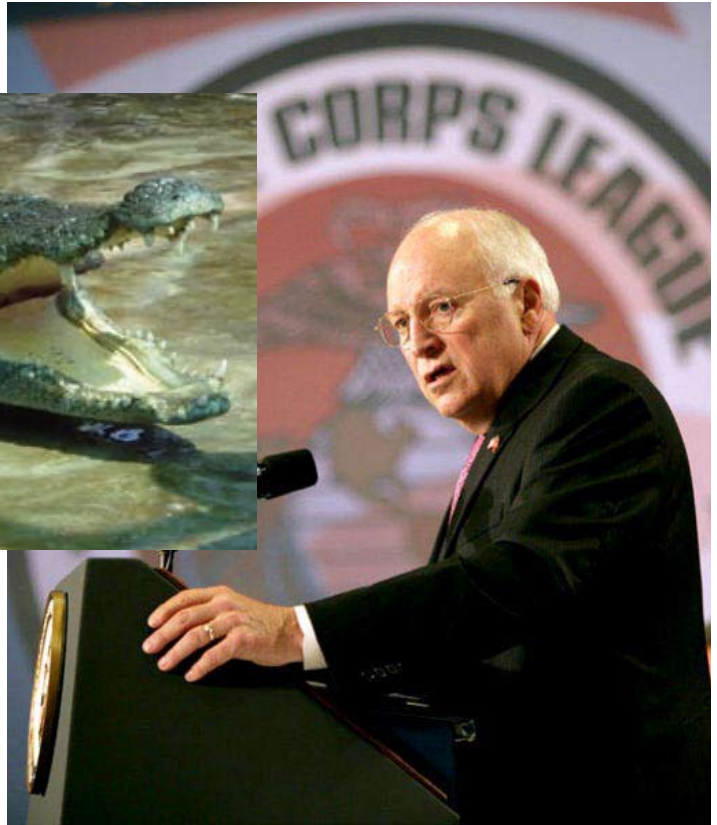

White House photo/David Bohrer

## The Function of the Triple Curve

This diagram (page 14) is composed of three elements in physical-space. Only one among these three elements is real; in this case, it is the downward curve which represents significant forms of net physical output measured per capita and per square kilometer. The other two curves are, respectively, volume of money in circulation (per capita), as compared with what is accounted as financial output/input per capita. In a healthy economic process, the rate of physical output per capita and per square kilometer is rising, both in absolute terms, and relative to monetary value of product produced and consumed.

When these ratios are re-stated in terms of the categories (for the whole economy) of “inorganic,” “Biosphere,” and “Noösphere,” rather than raw gross amounts, the source of the increase in net output is to be regarded from the standpoint of the Noösphere as, directly or implicitly, the fruit of both scientific-technological progress, both per capita and per square kilometer. In other words, an increase of productivity per capita and per square kilometer. This also represents, implicitly, an increase of effective capital-intensity, both per capita and per square kilometer.

These patterns are to be adjusted for what are clearly effects of price-inflation. It is urgent, that we eliminate any consideration of so-called marginal utility. Focus in upon two leading factors: physical productivity per capita and per square kilometer, as adjusted for gross financial expenditure, and, for reasons I explain below, scientific/Classical literacy.

The process of gains, in the case there were marginal net gains in physical output per capita and per square kilometer (as for the U.S. over the intervals, respectively, 1939-1964 and 1945-1964) when costs were adjusted for depreciation of capital improvements. Things became worse with the progress of the U.S. war in Indo-China, especially since about 1966; a new loss in physical-capital replenishment was evident from about 1966-1967 onwards. From about 1968-1970, the trend was increasingly “auto-cannibalistic,” especially as the post-industrial trend took over trend-setting.

All measurements are rightly reduced to the terms of physical productivity per capita and per square kilometer. We must take into account the relationship of raw increases in capital-intensity per capita and per square kilometer, to changes in physical productivity. We must also take into account what is fairly described as the “Classical culture” factor, as literacy in Classical modes of expression typify this as a cultural factor in promoting net productivity.

What underlies the function of improvements in scientific-technological progress (per capita and per square kilometer) is, first, pure physical science, and, second, the factor of increase of Classical literacy.

## Leibniz’s ‘Comma’

Return the focus of our attention to the matter of *intention*, as identified in the preceding chapter of this report. When the

term *intention* is used as I summarize the case here, intention has precisely the same connotations as universal physical principle in the work of Nicholas of Cusa, Kepler, and Leibniz, and in Bernhard Riemann's freeing of modern science from the claws of modern, neo-Cartesian expressions of empiricism and positivism.

The crucial notion of intention referenced by me here, is to be compared with the theological notion of the Creator's personal intention, as this matter was addressed in the celebrated manner that the subject was treated by Philo of Alexandria, in his denunciation of the Aristotelean theologians of his time.

The argument by Philo's neo-Aristotelean opponents, was, that if we wish to assert that the Creator's work was perfect, then it must be a finished Creation, without any margin for improvement. Hence, the literal reading of the neo-Aristotelean theology was that God, by creating the universe as perfect, had prevented Himself from any further willful form of intervention in its affairs, thus leaving the capacity to make further interventions to the whims of, perhaps, Satan, or, on some occasions either Vice-President Dick Cheney or the surrogate would-be god who refers to himself, blasphemously, as "the decider."

Admittedly, that curious argument was, in a manner of speaking, purely Aristotelean. However, it should be readily seen that, contrary to Aristotle, the universe never was, and never will be "completed," at least not "completed" in the specific sense of the Aristotelean Claudius Ptolemy's famous fraud in astronomy. The perfection of Creation lies in the reality that it is a *continuing creation*: in other words, an *anti-entropic creation*.

As I have already emphasized in preceding pages here, the universe as we know it is, so to speak, "upward evolutionary," or, in the formalities of scientific method, is anti-entropic: proceeding from relatively simpler, to more developed states of existence. This kind of upward development occurs only in two known ways: either as a built-in characteristic of the universe, or by the willful intervention to this effect by mankind, as *Genesis* 1 would also suggest.

That universe, so defined, is one of continuing, successive, qualitative changes, from relatively lower states of organization, to higher orders. As from solitary Sun to Solar System, and Suns to galaxies, and galaxies to galaxies producing the effects of super-super "Novas," a universe in which all acting components interact, not in a mechanistic, but a dynamic fashion, as Bernhard Riemann's developed notion of continuing processes of hypergeometric development implies.

Similarly, the discovery of actually universal physical principles, which occurs only through relevant modes of action within the sovereign bounds of the individual, creative human mind, defines man's willful role in promoting a self-developing universe of continuing creation, from qualitatively lower, to higher physical states.

So, the creative powers of the sovereign individual human mind, acting to produce an increase of man's apparent physical power over the Earth (and Solar System) per capita and per square kilometer of the Earth's surface, express the essential nature of the human individual, the absolute difference of such a human individual from any member of an animal species.

Hence, the implicitly Satanic evil expressed by "Malthusian" and related conceptions, such as those promoted by former U.S. Vice-President Al Gore. Whenever any culture, once successful, turns toward a "pro-Malthusian" orientation, such as that of Nobel award-winner Al Gore, that society has embarked on a voyage toward Hell, a path, such as that of the U.S.A. "Baby Boomer" elite of today, of willful, implicitly pro-satanic self-destruction of our planet's civilization as a whole.

If we consider President Franklin Roosevelt's expressed intentions for the post-war world, the "logical," so to speak, outcome of his knowledge and war-time experience of two "world wars," is that the cause of such warfare has been, typically, the existence of imperialist systems such as those of the Anglo-Dutch Liberal and related empires. If it were possible, at the close of the war, to eliminate imperialisms, the circumstances which would have tended to breed general warfare, could be controlled, by establishing a world-order premised on the prescribed universality of a system of perfectly sovereign nation-states. We know that that was Franklin Roosevelt's expressed intention for the post-war world.

The change which came with Roosevelt's death, on April 12, 1945, was President Truman's ripping up of what had been President Franklin Roosevelt's intention, by joining that faction of imperial Britain's Winston Churchill which was the avowed and fervent enemy of the freeing of subject peoples from Anglo-Dutch Liberal, French, and other manifestations of colonialism. The Anglo-American engineering of the unnecessary Truman conflict with the Soviet Union, was the paradigmatic feature of this Anglo-Dutch Liberal compact of President Truman with the British empire.<sup>23</sup> This issue, then,

---

23. After the experience of World War II, Stalin's Soviet Union wished no conflict with the U.S. Nor did Stalin intend an "imperial" sort of division of Eastern from Western Europe. The experience of awful war had brought about a great change, comparable in many ways to the circumstances of the adoption of the 1648 Peace of Westphalia. Under President Roosevelt, we of the U.S.A. had the world in our hands, if Roosevelt had not died. Inasmuch as our FDR's anti-imperialist policies against colonialism shaped the global environment generally, FDR, had he lived, was situated to lead in establishing a new order among a world composed of sovereign nations. We had the power under FDR; foolish Harry Truman threw that great power away. Russia's President Putin continues to seek to revive the essence of the intended post-World War II cooperation between Moscow and Washington. A similar opportunity, which was lost, existed in President Reagan's proffer to Andropov's Soviet Union. To lose the chances which are associated with "Kennebunkport" today would be a global catastrophe for all mankind for generations to come.

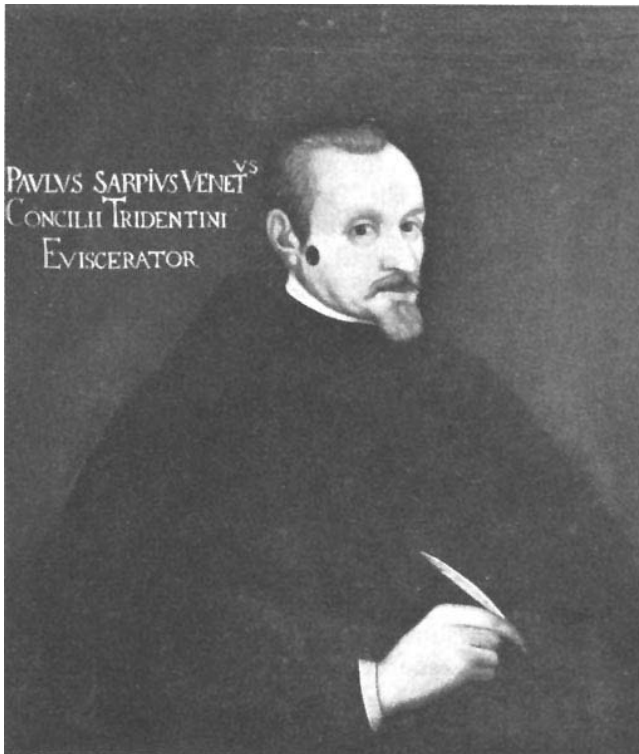

*Venice's Paolo Sarpi (1552-1623) introduced Liberalism (empiricism) as a trick to allow a certain latitude for innovations, but only by prohibiting the spread of knowledge of universal physical principles.*

was the exact same issue underlying the present British drive toward virtual warfare against Russia, and other targets, today.

The remedy for the continuation of a general threat of warfare, is, in principle, the principle of the 1648 Peace of Westphalia. To enact that agreement, the parties must be sovereign in their relations to one another.

Conflict in the sense of existential interest, is a disease of morals and opinion caused by cultural tendencies toward bestiality, tendencies which are fostered by the combination of brutishness imposed in obvious ways upon both so-called lower classes, and upon those assigned to hold such lower classes in check. The epitome of such moral diseases is imperialism, for which the epitome today, is the moral disease called Anglo-Dutch Liberalism.

Reflection on those and related considerations bring us to the matter of the other Nobel award, that of the cited trio of the Nobel economics award.

## **Systemic Empiricism**

As I have detailed the relevant argument in locations published earlier, modern *Liberalism*, as implicitly interchangeable with the term *empiricism*, was a trick introduced by Venice's Paolo Sarpi, a trick adopted by him in the effort to

outflank what was otherwise the defeat of traditional Venetian feudalist methods by the rise of the modern civilization launched by Nicholas of Cusa et al. in the setting of the 1439 great ecumenical Council of Florence.

The freeing of the mass of the population from the prevalent brutish obscurantism under the medieval Norman-Venetian system of feudal tyranny, had fostered a great increase of the efficient power expressed by the so-called lower and middle classes of European society. In the face of this new development in social relations, the Venetian faction was able to heap ruin upon the work of the Renaissance, but could not succeed in crushing a population which had gained new powers of resistance lacking in the earlier, medieval times. As I have already emphasized here, the "Old Venetian" faction relied on attempting a forced imposition of the proverbial "old ways," an intent which emphasized hatred of everything which Nicholas of Cusa had represented: both the conception of the sovereign nation-state republic, and emphasis on scientific and related progress in popular culture.

Sarpi recognized that it was precisely the "Old Venetian" faction's obsessive resistance to productive forms of innovation, which had become the key marginal factor of resistance to the Venetian's forces cause. However, Sarpi also recognized that the spread and advancement knowledge of universal principles was the factor which threatened to free society generally from continued domination by social institutions such as Venetian-style monetarism. Sarpi thought himself to have solved that existential paradox, by affording latitude for innovations contrary to Aristotelean rigidity, but, at the same time, prohibiting the spread of knowledge of the underlying universal physical and comparable principles which technologically progressive innovations express.

The compromise which Sarpi, Galileo, et al. adopted on this account, was to allow innovations expressed in the form of descriptive mathematical formulations, but to prohibit the types of crucial-experimental knowledge of universal physical and comparable principles typified by the work of the ancient Pythagoreans and Platonics, or the modern followers of Nicholas of Cusa, Kepler, Fermat, Leibniz, et al. The empiricist hoaxes of Descartes, de Moivre, D'Alembert, Euler, Lagrange, Laplace, Cauchy, Clausius, Grassmann, et al., typify the methods used to destroy mental access to the experimental proofs of principle which underlie successful progress in the fundamentals of scientific knowledge.

The cases of Hurwicz, Maskin, and Myerson are typical of a certain, extremist expression of empiricism, the "ivory tower" version of empiricism, as in the "arm chair" Sophistries of Ernst Mach and Bertrand Russell, which eschew the qualities of crucial physical-experimental methods which test hypothesized new, higher principles of scientific and related practice. Were such a morally disgusting scheme as theirs to be tolerated, future generations would mourn the ashes we shall have become very soon, under the crisis-conditions of today.

DUMP CHENEY NOW

## The Last Best Chance To Stop World War III

by Jeffrey Steinberg

Vice President Dick Cheney's continuing push for U.S. military strikes against Iran, which would trigger a global Hundred Years War conflagration, has once again put the issue of his removal from office at the center of any legitimate war-avoidance strategy. According to interviews conducted by *EIR* with dozens of American and foreign military officials, diplomats, and intelligence specialists, the Cheney-led war party has gained strength, despite massive opposition, and the prospects of a U.S. military attack on Iran have increased in recent weeks. The war danger will intensify, one senior U.S. intelligence source warned, until the Bush-Cheney team leaves office—or until Cheney is forced out.

A parallel factional brawl over the issue of war or peace, in the context of the unravelling of the global financial system, has erupted in Great Britain, centered around recent, temporarily failed, efforts to dump Prime Minister Gordon Brown, in favor of rabid neoconservative Tory Party leader David Cameron. The assault on Brown has been led by the *Daily Telegraph* (a.k.a. "Torygraph"), which has also been spewing a constant stream of war propaganda, targeting Iran and Syria with wild disinformation about "axis of evil" plots to arm both countries with North Korean nuclear bombs.

### The Ghost of 9/11...

The intensity of the fear that the Vice President will prevail on President George W. Bush to approve air strikes against select targets inside Iran, has prompted a number of prominent figures to revisit the issue of the Sept. 11, 2001 asymmetric warfare attacks on the United States. The Pandora's box was reopened on Oct. 10, when Lyndon LaRouche led off an international webcast from Washington with a pointed reminder that the 9/11 attack was an "inside job," carried out with the complicity of certain circles inside Saudi Arabia. LaRouche reminded the audience and viewers that he had issued

a public warning in January 2001, that the incoming Bush-Cheney Administration would use a "Reichstag Fire" incident to grab extraordinary police-state powers. His warning foreshadowed 9/11 by nine months.

At his webcast, LaRouche reviewed the events of 9/11, while cautioning the audience that he "knew far more" than he was prepared to reveal publicly. He later explained that he had posed the 9/11 issue in such stark terms because he was concerned about the danger that the same forces would attempt another such incident or some other pretext, to break the back of the resistance to the planned attack on Iran.

Other voices, for similar reasons, have spotlighted the "new 9/11" danger.

- Appearing on MSNBC's Countdown, on the evening of Oct. 10, John Dean, the former Nixon White House counsel, clearly identified Cheney's attempt to seize dictatorial powers immediately following the attacks of Sept. 11, 2001. The following exchange occurred between host Keith Olbermann and Dean, author of *Broken Government* and *Worse Than Watergate*, which document the crimes of the Bush-Cheney Administration.

In response to Olbermann's final question about how, in 2001, Cheney was so well positioned to take advantage of the aftermath of the attacks, i.e., "how so much [power] was rolled out so quickly" to the White House, Dean responded: "Well, we know [what] a number of the think tanks were hoping or saying. I'm not saying they are hoping that the travesty and tragedy that did occur would occur, but they certainly thought they needed a triggering event to get a lot of their policies that they had been developing for years; the neoconservatives saw this as an opportunity. It was already in the drawers. They just opened them and used 9/11 to push everything through...."

- On Oct. 16, the Public Broadcasting System's "Front-

line” aired a one-hour documentary, “Cheney’s Law,” echoing LaRouche and Dean’s accounts of Cheney et al.’s unconstitutional power grab on 9/11.

- On Oct. 20, the *Los Angeles Times* published a strongly worded editorial, “Avoiding World War III,” seizing upon President Bush’s blustering threat to the Iranian government, during a press conference on Oct. 17, that if they continued to pursue a nuclear weapon, they could precipitate a Third World War. Bush came across as positively deranged, during the question-and-answer period, ranting about Iranian President Mahmoud Ahmadinejad’s vows to wipe out Israel, as cause for the United States to launch a preemptive World War III.

While acknowledging that some of Iran’s actions have not been constructive, the editorial warned, “Despite the very real causes for U.S. complaint, the escalation of American threats against Iran is unwise. It is grossly premature. It is dangerous, as it greatly increases the likelihood of accidental escalation into a preventable war. It is alarmingly ill-timed, as an isolated United States wages simultaneous ground wars in Iraq and Afghanistan, and both conflicts are going badly. And it is diplomatically counterproductive. Congress and U.S. opinion leaders should slam on the brakes—if they can.”

After warning that “Bush’s bluster is backfiring,” the *Times* editorial concluded, “Finally, Bush should be discouraged from threatening Iran—either directly or via leaks about Cheney’s alleged enthusiasm for bombing—because Americans cannot be sure that he *is* just bluffing. Should a future U.S. president find it necessary to consider military action against Iran, he or she would need the support of Congress, the military, the American people and many other nations. Bush can muster none of the above. He should stick to diplomacy.”

A day earlier, *Washington Times* war propagandist Bill Gertz had twisted remarks by the new chairman of the Joint Chiefs of Staff (JCS), Adm. Michael Mullen, who gave his first press conference since being sworn in on Oct. 1. Under the provocative title “Mullen: U.S. Can Strike Iran,” Gertz wrote that, “Defense and military officials have been preparing U.S. forces within striking distance of Iran. The forces would be dominated by Navy and Air Force weapons and forces since Army and Marine Corps forces are focused on Iraq and Afghanistan. There are two main targets of any Iranian military action, according to officials. First, U.S. forces are set to attack Iranian Islamic Revolutionary Guards Corps facilities because of the paramilitary’s support and provision of armor-piercing roadside bombs. A U.S. official said the location of a factory where Iranian bomb materials are being produced has been identified. A second target would be Iranian nuclear facilities, which are in numerous underground facilities across the country.”

In fact, both Admiral Mullen and Defense Secretary Robert Gates, who appeared with the new chairman at the Pentagon press conference just a day after President Bush’s reck-

less remarks, emphasized the importance of the Bush Administration’s diplomatic efforts. Mullen has quietly warned colleagues and reporters that, when he came into the chairman’s office, he was alarmed to find that the Iran confrontation had been placed at the top of the list of priorities coming from the White House to the JCS.

Nevertheless, military commanders and civilian leaders are clearly coming under enormous White House pressure, emanating principally from the Vice President, to keep publicly showing the threat of U.S. military action in the face of Iranian leaders.

### ...And the Putin War-Avoidance Option

Beyond warnings that the Cheney war rhetoric could trigger a Third World War, other U.S. political figures are joining LaRouche in pushing a Great Powers alternative to global confrontation and the plunge into a New Dark Age. LaRouche was among the first leading political figures to endorse the offer of strategic partnership, presented by Russian President Vladimir Putin, during his early-July visit with President Bush and former President George H.W. Bush, at Kennebunkport, Maine.

On the eve of the recent “two-plus-two” meetings in Moscow between U.S. Secretary of State Condoleezza Rice and Defense Secretary Gates, with President Putin and their Russian counterparts, Sen. Richard Lugar (R-Ind.), the ranking Republican on the Senate Foreign Relations Committee, delivered a speech at the Brookings Institution in Washington, on Oct. 8, embracing the Putin proposal, and tracing its roots to President Ronald Reagan’s Strategic Defense Initiative (SDI), a program that was the fruit of collaboration between Reagan and LaRouche.

“President Putin’s proposal ... is surprisingly similar to the strategic vision that President Ronald Reagan laid out more than two decades ago,” Lugar stated.

The U.S. and Russia should consider “the establishment of jointly manned radar facilities and exchanges of early-warning data,” Lugar proposed, adding that the two countries “might consider placing Russian liaison officers at U.S. missile defense tracking sites, in exchange for U.S. officers in Russian strategic command centers. The transparency gained from such steps would be useful in offering reassurances that these radars are not meant for spying on Russia.” This latter proposal is being mooted by those who would like to see a Russian-U.S. agreement, but are not willing to renege on the previous plans regarding deployment of U.S. missiles in Poland and a radar in the Czech Republic, something the Russians continue to indicate would be deal-breakers.

Such clear U.S.-Russian collaboration on strategic defense would deliver a powerful message of war-avoidance, and should be adopted immediately. But beyond such actions, the forced removal of War-Monger-in-Chief Dick Cheney from office remains the most direct means for preventing World War III.



# Blackwater Nazis Aim Homeward: Kristallnacht in Virginia?

by Anton Chaitkin

Greg Ahlemann is running for sheriff of Loudoun County, Va., by trying to incite mob anger against illegal immigrants. The *Washington Post's* Oct. 12 profile of the Republican nominee focussed on the weird tattoo on his arm: the logo of crusaders for an Armageddon religious war, showing a colonial American flag and Israeli flag joined together by a cross. Ahlemann hurriedly convened a press conference on Oct. 15 to warn of illegal Hispanic immigrants as a crime threat—and to show off his tattoo. Ahlemann aimed his vitriol at the incumbent Steve Simpson, for his refusal to join the anti-immigrant hysteria.

Half a world away, mercenaries gone murderous-wild in Iraqi streets provoked the government there to demand that the firm Blackwater USA be expelled from Iraq. The Blackwater scandal ripped through Congress, as Washington was haunted by the specter of global warfare to be run by fascist private agencies.

This is the agenda of *British System* über-financiers Felix Rohatyn and George Shultz, as implemented by Dick Cheney's and Donald Rumsfeld's "Revolution in Military Affairs."

The Rohatyn Center for International Affairs (Middlebury College, Vt.) ran an October 2004 conference on "Privatization of National Security," where, in partnership with Bush Administration architect, George P. Shultz, Rohatyn advocated a future world of private wars modeled explicitly on the feudal dark ages and the conquests of the British East India Company.

That future is now, and here at home.

Besides deploying its own mercenaries, Blackwater also trains American law enforcement personnel at all government levels. The Blackwater gang is reaching for power in domestic law enforcement, and the privatized police functions would be amalgamated with anti-immigrant vigilante mobs.

*EIR* has established that the Greg Ahlemann incitement-candidacy is part of an international theocratic, fascist underground, connecting the Blackwater corporate leadership to armageddonist Protestant and Catholic operatives.

Some global centers of this movement are just outside Washington in Northern Virginia: Christendom College (Front Royal), a political offshoot of Francisco Franco's Spanish fascism; Supreme Court Justice Antonin Scalia's St. Catherine of Siena Catholic parish (Falls Church); and Charles Colson's Prison Fellowship Ministries (headquartered east of

the Loudoun County seat of Leesburg).

"Spooks" from these precincts aim to steer behind them crowds of Americans demoralized by the gathering storm of economic collapse.

## Vigilantes and Mercenaries

Through the night of Oct. 17, over 1,000 pro- and anti-immigrant activists clashed at the meeting of the Board of Supervisors of Prince William County, Va. At 2:30 the next morning, the Prince William Supervisors voted 8-0 to set up a Criminal Alien Unit of the county police, and to deny certain public services to illegal aliens. The illegals would be flushed out by police demanding proof of citizenship during routine traffic stops and other interactions.

These scenes evoke 1930s Germany; *Kristallnacht*, the night Hitler's stormtroopers broke windows of Jews scapegoated in the Great Depression disaster; and the Gestapo, demanding, "Where are your papers?"

The Prince William ordinance was co-drafted by a vigilante organization known as "Help Save Virginia," with subsets Help Save Manassas, Save Herndon, and Save Loudoun. This is the Virginia public face of the movement called the Minutemen, which deploys vigilantes to the Mexican border. The "Help Save" website runs appeals for contributions directly to the Minutemen.

Virginia Minutemen chairman George Taplin was manning the "Help Save" booth on Oct. 7 at the Sterling Fest in Sterling Park, Va. He ran the Help Save/Minutemen movement's anti-immigrant agitation in Herndon, Va., and led their incursion into Loudoun County in January 2007. The vigilantes are one deployment of the national anti-immigrant movement, whose leaders include Congressman Tom Tancredo (R-Colo.) and fascist Harvard professor Samuel Huntington, of "Clash of Civilizations" infamy.

A bill was introduced in 2006 into the U.S. House of Representatives (H.R. 6015) for the government to hire 5,000 to 8,000 mercenaries to patrol the border with Mexico, and to have private contractors such as Blackwater USA take over the training of the U.S. Border Patrol. Cosponsors included Reps. Tancredo, Eric Cantor (R-Va.), and Roy Blunt (R-Mo.). The bill's prime sponsor, Mike Rogers (R-Ala.), had previously brought Blackwater president Gary Jackson to Congress to speak on how Blackwater could privatize Border Pa-

trol functions.

Blackwater was set up in 1996 by Michigan billionaire Erik Prince. Guided by his religious-political shepherd Charles Colson, Prince has bound himself and his company to impose a Dark Ages in social and political life, a return to Inquisition rule, crusaders, and mercenary wars. In 2001, Prince gave \$500,000 to Colson's Prison Fellowship, through the Prince family's tax-exempt Freiheit Foundation.

Infamous as a convicted Watergate conspirator, Colson later forged an alliance of "evangelicals" with far-right Catholics. Colson and his cohorts published in November 1996 a diatribe entitled "The End of Democracy?," calling for theocratic Christians to overthrow the no-longer-legitimate U.S. constitutional "regime." A convert to Catholicism, Prince has also funded the pro-Franco Legion of Christ.

Blackwater's Chief Operating Officer and General Counsel is Joseph Schmitz, formerly Pentagon Inspector General under Defense Secretary Rumsfeld, and a leading operative of the underground theocracy. Schmitz's father, the late California far-right Congressman John G. Schmitz, converted his aide Warren Carroll to Catholicism, and set him on the path to his intrigues in Spain with pro-Franco circles. This led to Carroll and the William F. Buckley family founding Christendom College, an agitational center, since sponsored by the Schmitzes and funded by Blackwater's Erik Prince.

Blackwater has put into Iraq hundreds of mercenaries formerly in the security services of Chile's Augusto Pinochet, the dictator whose death squads were whitewashed by Pinochet public relations chief William F. Buckley and his friends at Christendom.

## Target: Virginia

Charles Colson's headquarters is just up the street from the Christian Fellowship Church in Ashburn, a congregation grown gigantic under its pastor James (Jay) Ahlemann, the father of Greg Ahlemann. Rev. Ahlemann is the chief funder of his son's sheriff campaign.

The senior Ahlemann is a disciple of political-religion manager James Dobson, whose Family Research Council was financially organized by the father of Erik Prince, with the young Erik Prince as an intern. In 1998 Rev. Ahlemann led a mob-incitement against the building in Loudoun County of a Muslim academy. Anti-Muslim leaflets were passed through the Ahlemann church from the Federation for American Immigration Reform, founded by apocalyptic race-warrior William Paddock. Ahlemann had a local action arm called Concerned About Loudoun's Future, run by Sandra Elam—a fanatic who bases herself in Scalia's St. Catherine of Siena parish, a center for Inquisition Catholics like the Legionnaires of Christ. The Ahlemann-Elam group threatened to purge county officials who voted to allow the Muslim school's construction.

Rev. Ahlemann was later asked to leave his church for reasons which are unclear. He now runs Nazi-like anti-immigrant

organizing through a network of smaller congregations in Virginia's Fauquier, Prince William, and Loudoun counties, and television and radio stations he owns in the Winchester-Warrenton-Front Royal area.

It was in the vacuum of the dispirited local Republican Party, that a rightist clique recently staged a little coup to make Greg Ahlemann, a loose-cannon former patrol officer, the party's sheriff nominee.

At his Oct. 15 press conference, Ahlemann blustered about the "alien" crime threat, but could not produce even a guess about the numbers of illegal immigrants, or cite any instances of criminal activity. Asked if he works with the Minutemen, Ahlemann lied by indirection: no, he said, only with Save Loudoun—the Minutemen's local public face. He acknowledged that there is a deep crisis in the housing market collapse. To make up for tax revenues that will be lost, he promised to slash the budget for public services. But an economic crisis can be useful politically, to those whipping up the masses against the Hispanic scapegoats.

## Crossing the Line

Harvard's Samuel Huntington is lead strategist for the anti-immigrant crusade, the philosopher alike for Blackwater and the border vigilantes, made famous by his 1996 book, *The Clash of Civilizations*, promoting anti-Islamic world war as inevitable.

Huntington explained in his 2004 book *Who Are We? The Challenges to America's National Identity*, what his movement would do in an economic crisis: "The large and continuing influx of Hispanics threatens the pre-eminence of white Anglo-Saxon Protestant culture and the place of English as the only national language. White nativist movements are a possible and plausible response to these trends, and in situations of serious economic downturn and hardship they could be highly probable..." He assured his readers that the "new breed of white racial advocate" is "cultured, intelligent, and often possessing impressive degrees from ... premier colleges"—perhaps not a precise depiction of the knuckle-dragger sheriff candidate.

Blackwater USA's preferred hell-world of limitless mercenary wars was prefigured in Huntington's 1957 *The Soldier and the State*, attacking the concept of the republic's military: "The professional army ... is far more reliable than the political army which fights well only while sustained by a higher purpose.... The supreme military virtue is obedience." He lauded the Korean War, where the American soldier "fought solely and simply because he was ordered to fight it and .... he developed a supreme indifference to the political goals of the war...."

Now, when a political clique employs both "indifferent" Blackwater troopers, who kill for effect in Baghdad, and religious fanatics promoting racial hatred in an emerging political-economic crisis, it is well to be warned that a fundamental danger line has been crossed.

# Third World War or New World Economic Order?

by Helga Zepp-LaRouche

When President Bush talks about the Iranian nuclear program in the context of World War III, the world had better wake up. The danger of a Third World War is indeed posed, but not from the possible construction of Iranian nuclear weapons. The Russian government, whose engineers are building the nuclear power plant in Bushehr, have once again stressed, that they have no evidence that Iran is working to develop nuclear weapons. The American intelligence services themselves, in their official National Intelligence Estimate, have come to the conclusion that Iran, from a purely technical point of view, is at least five years from the possibility of developing nuclear weapons; and ElBaradei spoke recently of a breakthrough in the access to the Iranian nuclear facilities being given to IAEA inspectors.

On the other hand, a number of American sources, including Presidential candidates Rep. Dennis Kucinich (D-Ohio) and Rep. Ron Paul (R-Tex.), journalist Seymour Hersh, intelligence agent Philip Giraldi, and numerous retired generals, have warned of the artificial staging of an incident à la the Gulf of Tonkin, on the Iraqi-Iranian border or in the Strait of Hormuz, which would be used to create the pretext for a U.S. military strike against Iran. The consequences of this would be an uprising of the Shi'ites in Iraq, a fundamentalist coup in Pakistan, which could lead to a preventive strike by India against Pakistan—and a Third World War as the result.

For Russia, which has its own security interest in making sure that Iran uses nuclear energy only for peaceful purposes, the American plans to station missile defense systems in Poland and the Czech Republic are very threatening. Once they have been installed, these systems could be quickly converted into offensive systems, and could reach Moscow in three minutes. In view of this potential threat, Russia's Novosti military

analyst Nikita Petrov warned of a new Cuban Missile Crisis in reverse, in which it would be unclear whether the agreement reached at the last minute between Kennedy and Khrushchov in 1962 could be achieved this time.

In view of the aggravated situation in both of these crisis situations in Iran and East Europe, the last Prime Minister of East Germany, Lothar de Maizière, was absolutely right, when he opened the Seventh Petersburg Dialogue in Wiesbaden [Germany] (Oct. 13-15) with the words that this forum of German-Russian discussions was taking place amid omens of a certain explosive nature, which he linked especially to the image of Russia in the West, which, in his view, is not always the best—a somewhat euphemistic reference to the anti-Putin campaign in the Western media.

The last President of the Soviet Union, Mikhail Gorbachov, looked at this “explosiveness” from the standpoint of: What kind of defense alliance is NATO, when the allies are not once asked for their opinion about such a profound question as the missile defense systems in Poland and the Czech Republic? And when the U.S.A. made its plans known, Western Europe did not respond, although the people of Poland and the Czech Republic are also against the stationing of these systems. It's probably because of [Robert] Gates' inexperience as Defense Secretary, noted Gorbachov ironically, that Gates said that it might be necessary to wage war against China and Russia. In any case, all arms control treaties that have been concluded are now called into question, and could fall apart.

Similar dissatisfaction with Europe was expressed by Prof. Igor Maximychev of the Europe Institute of the Russian Academy of Sciences, who pointed out that Russia had long pleaded with the West to desist from the eastward expansion

of NATO, which could only have nasty consequences, and not to foment an anti-Russian campaign in the media. On both points, the European Union remained silent, and these actions have continued, to the point that Russia has been put up against the wall.

Professor Schultze of Göttingen University indicated that the high point of the European Union was at the end of 2005, and that the eastward expansion of the EU turned out to be a pyrrhic victory. And, as for the absorption of Georgia into NATO, neither the EU nor Russia has an interest in destabilizing the areas between them in Europe.

At the Petersburg Dialogue, the schizophrenia of the policy of Germany's Grand Coalition was perfectly evident. Only in the working groups that dealt with questions of economic cooperation, education, and science, was it clear that qualitative progress has been made, and that it serves the interests of both sides. Thus there are about 4,600 German *Mittelstand* [small and medium-sized] enterprises that have invested in Russia, and that have made excellent deals there. The chairman of the East Committee of the German Economy, Dr. Klaus Mangold, stressed: "Russian businessmen that want to invest in Germany, would be welcomed with open arms." On the Russian side, it was stressed emphatically, that still more engagement of this sort is desired.

## Sophistry of the West

In dramatic contradiction to these most welcome, fully rational debates over economic ties, were the discussions about politics, the EU, Russian relations, civil society, democracy, human rights, etc. These themes were handled by the Western side in a critical and sophistical manner. Many Russian participants characterized these discussions as "absolutely frightful." The middle-sized powers in the West simply refused to understand, that the brutal exploitation that Russia was subjected to by the oligarchs, with Western help, after the collapse of the Soviet Union, had made the word "democracy" a curse word.

In fact, people in the West seem to have forgotten that the so-called "reform policy"—shock therapy à la Jeffrey Sachs—reduced Russia's industrial potential by 30% from 1991 to 1994. Mikhail Margelev, chairman of the Committee for International Affairs of the Russian Federation, formulated it thus: "In the 1990s, we were hungry." And if Russia has now become economically strong again, this does not mean that it has become "fearsome." We are working to build a sovereign state, not an empire, he said. But we absolutely do not want to be an "Upper Volta with missiles"—an allusion to the attempt of Anglo-American political opponents, after 1991, to degrade Russia from a superpower to a raw materials-exporting Third World country.

Those on the German side that are interested in a good relationship to Russia, stressed the necessity of meeting Russia at the same eye level.

Representatives of the anti-Putin campaign left no doubt

of their preference for the former Yukos chief and oligarch Mikhail Khodorovsky.

Gorbachov, who expressed his full support for Putin, made an important point, that in relations between Russia and Europe, more ideas and more projects must be generated. But this was missing at the Petersburg Dialogue, as the "talk show" style is ill-suited to the discussion of ideas, and the level remained several rungs below that of the Kiedrich conference of the Schiller Institute, which took place in the middle of September, on the building of the Eurasian Land-Bridge as a project to promote peace in the 21st Century, and a cultural and scientific renaissance.

President Putin, who participated in the dialogue at the closing dinner, along with Chancellor Angela Merkel, and went from there to Tehran, to a summit meeting of the Caspian Sea countries, introduced the idea of problem-solving through dialogue: He demanded the solution of the conflicts over Iran's nuclear program, on the model that the North Korean problem has been solved—also with great patience in negotiations, and with a view to the justifiable interests of Iran.

## The Development Alternative

It was clear that the Kiedrich Schiller Institute conference was much closer to the ideas that can change the world in a positive direction, in light of the Arctic Energy Summit of Oct. 15-18 in Anchorage, Alaska. There, the subject was progress in the railroad and tunnel projects across the Bering Strait, which would link Siberia and Alaska with a 6,000 km railroad bridge and a 100 km underwater tunnel. The Russian members of the "Interhemispheric Bering Strait Tunnel and Railroad Group" told the press: "At this moment, where we are standing, the work on this project has already begun." Russian Academy of Sciences member and president of the Kurchatov Institute of Nuclear Physics, Yevgeni Velikhov, underlined the importance for nuclear energy and high-technology variations for all component parts of the projects. Alexander Sergeev, of the firm RosHydro, stressed that Russia has already begun to build its part of the project, WorldLink. The machines are already working to build the hydroelectricity for building the railroad lines.

The fact that prominent American representatives, including the former governor of Alaska, Walter Hickel, and the current governor, Sarah Palin, support the project, and that U.S. Sen. Lisa Murkowski (R-Ak.) and Assistant Secretary of State Dan Sullivan took part in the conference, gives reason for hope that the development of the northern Arctic and the northern region of the U.S.A., Russia, and Canada, will be a key for an alternative to a new Cold War or a new Cuban Missile Crisis. Just at the point that the systemic collapse of the globalized world financial system is becoming ever more obvious, this construction of the world economy with the implementation of the Eurasian Land-Bridge at its core, must be on the international agenda.

# U.S.-Russian Missile Defense Talks Have Reached a Turning Point

by William Jones and Marsha Freeman

The Oct. 12-13 2+2 ministerial meeting in Moscow on ballistic missile defense at first appeared to deadlock over U.S. plans to deploy ABM systems in the Czech Republic and Poland. Not only had the U.S. side made clear that it had no intention of jettisoning its deployment plans, but the Russians, from President Vladimir Putin on down, insisted that constructive dialogue depended upon the United States putting those plans on hold. One commentary in the Russian news agency Novosti, went so far as to compare the escalating confrontation over the ABM systems to the Cuban Missile Crisis.

Yet, in the days subsequent to the talks, the U.S. side revealed that it had a new proposal on the table, and Russian spokesmen made statements indicating their hope that the dialogue could continue, with Putin himself saying Oct. 17, in an interview with Iranian reporters in Tehran, "I must say that our latest meetings with our American partners show that it is possible for their view on this matter to undergo a certain transformation, and we will continue the dialogue."

Crucial to the progress of such talks will be the extent of the influence of U.S. elder statesmen such as Sen. Richard Lugar (R-Ind.) and former Secretary of State Henry Kissinger, who have spoken out in recent weeks urging the Bush Administration to respond positively to President Putin's Kennebunkport proposal for U.S.-Russia collaboration on ballistic missile defense.

## Putin's Proposal

When he met with President Bush in July at the Bush family estate in Kennebunkport, Maine, Putin proposed that the United States and Russia cooperate in a joint missile defense effort against possible threats, utilizing a radar in Azerbaijan that is leased by Russia. Putin's proposal countered a provocative plan by the United States, ostensibly to protect against missiles coming from Iran, to place ten interceptor missiles in Poland and a radar in the Czech Republic—which Russian officials, as well as U.S. experts such as MIT Prof. Theodore A. Postol, identify as a threat to Russia's strategic deterrent.

Putin's overture revived the efforts that had been made in the last decades, beginning with President Reagan's 1983 adoption of Lyndon LaRouche's proposal, by launching his Strategic Defense Initiative (SDI), and also includ-

ed Russia's 1993 "Trust" proposal, to shift away from MAD brinkmanship, and create a broad cooperation between the two Cold War opponents in the area of missile defense.

In his meeting with the Russian President at Kennebunkport, President Bush expressed interest in the Putin proposal, and the two appointed their respective defense and foreign ministers to begin working on the problem, to come up with a solution. Since Kennebunkport, there have been a series of meetings between Russian and U.S. "expert groups," with representatives from the Defense and State Departments, working with their Russian colleagues, on the details of such a collaboration. They have visited the radar site in Azerbaijan to judge what effect this would have on the ability to deal with a possible threat from Iran. Later, President Putin indicated that Russia would also be willing to allow the use of another, more modern, radar site, under preparation in southern Russia, as a part of the package.

The major point of contention has been the plan to place U.S. missiles in Poland and radar in the Czech Republic. The United States has refused to abandon this proposal, and has insisted that the Russian radars be complementary to, rather than an alternative to, the Polish and Czech facilities. But it is precisely those facilities which are regarded by Russia—with good reason—as a potential threat.

## U.S. Voices for Sanity

The leading supporter of Putin's Kennebunkport proposal in the United States has been Lyndon LaRouche, the intellectual author of the SDI. But there have been other high-profile individuals in the U.S. political establishment weighing in, urging the Administration not to lose this important opportunity.

In a speech to the Brookings Institution on Oct. 8, Senator Lugar, the ranking member of the Senate Foreign Relations Committee, stated: "The Russian missile defense proposal provides an important strategic opening for further discussion and exploration. President Putin's proposal is not new. In fact, it is surprisingly similar to the strategic vision that President Ronald Reagan laid out more than two decades ago. I am pleased that the Administration is seriously studying Putin's offer on missile defense."



Russian Presidential Press and Information Office

*At the Oct. 12-13 ministerial meeting on ballistic missile defense, Russia and the United States agreed to continue such meetings. Here, President Vladimir Putin (right) greets Defense Secretary Robert Gates, as Secretary of State Condoleezza Rice looks on.*

In an editorial in the *International Herald Tribune* on Aug. 9, Henry Kissinger also indicated the importance of such an agreement. “Putin’s initiative to link NATO and Russian warning systems could be—or could be made—an historic initiative in dealing jointly with issues that threaten all countries simultaneously,” Kissinger wrote. “It is one of those schemes easy to disparage on technical grounds but, perhaps like Reagan’s Star Wars vision, is a harbinger of a future posing entirely new creative opportunities. It permits one to imagine a genuinely global approach to the specter of nuclear proliferation, which has heretofore been treated largely through national policies. And such an approach could become a forerunner for other issues of comparable dimension.”

Kissinger reiterated his view that the Bush Administration should respond seriously to Putin’s proposal on Oct. 18, after a meeting of the U.S.-Russian Business Council in New York.

### **The Moscow Negotiations**

Putin made his point clear, when he met with Secretary of State Condoleezza Rice, Secretary of Defense Robert Gates, and his own defense and foreign ministers in Moscow on Oct. 12, prior to their discussions on the issue. “The one point I would like to make,” Putin said, “is that we hope that you will not push ahead with your prior agreements with Eastern European countries while this complex negotiating process continues.” He added, “After all, we could decide some day to put missile defense systems on the Moon, but if we concentrate solely on carrying out our own

plans, we could end up losing the opportunity for reaching an agreement. But we see that our American partners are showing a constructive desire to continue the dialogue and we think this is a very positive signal.”

Russian Foreign Minister Sergei Lavrov was more blunt: No progress would be made unless the U.S. Eastern European plans were frozen. This should be acceptable, Lavrov stated, because it will be years before Iran has either nuclear weapons, or a long-range missile to deliver them. This was restated by Chief of Staff Gen. Yuri Baluyevsky on Oct. 17: “We continue to say this without equivocation, and it is our deep conviction, founded on real knowledge of the situation in Iran, concerning its capacity to create intercontinental ballistic missiles. We do not see that it would be possible to do this in the near future, or in the medium term, or that it is simply possible at all” for Iran.

Lavrov reiterated at a press conference at the conclusion of the ministerial-level meetings, that there is no hurry to plan a European ballistic missile defense system. “We believe for the joint work of Russian and American experts to be efficient, the plans to deploy the third positioning region in Europe [Poland and the Czech Republic] should be frozen. There is no agreement on this, but we encouraged our experts to discuss the existing divergences in a very concrete and specific way.”

In comments following the ministerial meetings, Gates addressed the Russian concerns. “We also addressed the possible concern on the Russian side that while the sites in the present design form pose no threat to Russia or its deterrent, the concern that in some future date, years from now, they might do so, and our willingness to work with the Russians to provide assurances and reassurances on that—in that respect,” Gates said.

What Gates offered was that the Russians could have observers at many, or perhaps all, of the anti-missile facilities. Without revealing the full contents of the U.S. proposal, Gates told reporters that, “There were several components to the suggestions that we made. I think the one that I’ll just mention is in furtherance of transparency. We put forward some thoughts about the presence of individuals from both sides at sites so that there was complete transparency both at—perhaps at third sites, but also in the U.S., and if there are radars and other facilities here in Russia, that there would be a presence there, too. So some of the proposals affected the transparency and sharing of information.”

To this, General Baluyevsky countered, that it is nothing new, and that it is completely unacceptable for the United States to consider the facilities being offered by the Russians as part of the U.S. ABM system.

### **New U.S. Proposals**

After the Moscow meetings, the U.S. delegation left to brief NATO allies on the progress of the talks, and further aspects of U.S. “suggestions” made to the Russians at the 2+2 meeting were revealed. In comments at NATO headquarters in Brussels, where Russian Foreign Ministry disarmament director Anatoli Antonov and first deputy chief of staff of the Space Forces, Alexander Yakushin, were present, Daniel Fried, U.S. Assistant Secretary of State for Europe, revealed an offer to step back from the Poland and Czech deployments.

“Our real concern is not Russia,” Fried told reporters. The defense system is “intended against the major problem we see developing, which is Iran, and if that problem went away, or attenuated, we would obviously draw conclusions,” he said. “This is a threat-based system, and we would be affected if Iran gave up its [uranium] enrichment and worked with the international community, and had a different approach to things.”

Apparently ignoring President Bush’s psychotic outburst at a press conference in Washington the same day, where he ranted that those who would not stop Iran are gunning for World War III, Fried said: “Our position is that our negotiations with the Poles and Czechs will continue, but we don’t feel the need to spend money at quite as fast a rate for a threat that is attenuated. You don’t stay on autopilot; you use your brain and judge things as they actually emerge.”

Speaking to reporters after the meetings in Moscow, a senior Administration official who was engaged in the talks, said, “. . . what is, I think, of great interest is that the ideas that were brought to the table, both in the experts’ talks and by the ministers in their discussion with President Putin, and in the 2+2, are of sufficient interest that the experts’ talks are going to continue and that we are going to continue to work on whether we can narrow the differences even further and ultimately bring these positions together.” Another 2+2 ministerial meeting is scheduled in six months’ time in Washington, and during the interim, the “experts” will again try to thrash out the details of a possible agreement.

That the U.S. Eastern European deployment plan could ever go ahead is not self-evident, as the populations in both Poland and the Czech Republic have been very hesitant to have any foreign soldiers operating on their soil, and would no doubt have reason to object to a Russian military presence. The U.S. Congress, so far, has also put a hold on the inclusion of any funding for a Polish/Czech deployment in the FY08 Defense Department budget.

### **A New Relationship?**

The U.S. proposal on the East European missile deployment has also caused further complications in the U.S./Russian strategic relationship. In July, President Putin signed a decree suspending Russia’s participation in the 1990 treaty on Conventional Forces in Europe (CFE), which had created a balance between NATO and Warsaw Pact conventional forces in Central Europe. Although the CFE Treaty had already become something of a sticking point for Russia after the demise of the Warsaw Pact, when the “balance of forces” in that treaty were totally thrown out of whack, the possibility of missiles in Poland only hardened Russia’s determination to jettison the treaty.

Putin has also mooted opting out of the 1987 Treaty on Intermediate Nuclear Forces (INF Treaty), which eliminated U.S. and Russian medium-range nuclear missiles in Europe. Both Putin and Russian military leaders have indicated that Russia might be forced to target East European missile sites if the United States followed through on its original proposal.

But on Oct. 17, General Baluyevsky moderated the Russian position on the INF Treaty, stating that “breaking this Treaty could lead to irreversible consequences, when a large number of countries will equip missiles with high-precision warheads and more exotic types of WMD.” In a similar vein, Brig. Gen. Kevin Ryan (ret.), former chief of staff of the Army Space and Missile Defense Command, wrote in the *Los Angeles Times* on Oct. 16, that the INF Treaty should not be scrapped by the United States and Russia, but rather should be expanded at least to place an upper limit on—if not eliminate—medium- and short-range missiles from Europe. Similarly, earlier this month, Putin called for the INF Treaty to be made “universal in nature.”

In addition, Russia is concerned by the apparent U.S. unwillingness to sign a follow-on treaty to START, the Strategic Arms Reduction Treaty, which limits intercontinental nuclear missiles, when it expires in 2009. A senior Administration official indicated, however, that the two sides would be working to put together a “strategic framework” agreement for the next meeting of the 2+2, in Washington.

The fact that the two sides are determined to continue the 2+2 format, perhaps even making this a permanent feature of the U.S.-Russia relationship, must be taken as a sign of progress. In his Kennebunkport comments, Putin stated his hope that an agreement on missile defense could take the entire U.S.-Russia relationship to a new level. This is possible, only if Cheney and company do not succeed in sabotaging a missile-defense deal. But if they do succeed, Russia will become convinced that the goal of U.S. policy is simply to isolate, and ultimately destroy it as a great power. And Russia would be right.

# Putin Puts Forward A War-Avoidance Plan

by Muriel Mirak-Weissbach

The visit to Tehran on Oct. 16 by Russian President Vladimir Putin, was officially billed as his participation in the second summit of the Caspian Sea littoral nations, convoked to deal with legal and other aspects of resource-sharing in the oil-rich waters. Although that summit did take place as scheduled, and important decisions were reached by the leaders of Turkmenistan, Kazakstan, Russia, and Iran, the main thrust of Putin's visit was another: The Russian President's trip—the first of a Russian head of state to Iran since the 1943 Tehran conference of war-time powers—was geared to register his government's commitment to prevent a new war in the region, at all costs. That new war is the one on the strategic agenda of U.S. Vice President Dick Cheney, against Iran.

Putin's participation in the summit, especially, his extensive personal meetings with Iranian President Mahmoud Ahmadinejad and Supreme Leader Ayatollah Ali Khamenei, constituted a spectacular gesture manifesting Russian support for war-avoidance factions in the Iranian government, in their showdown with Cheney's neocon war party. As one Iranian political source put it to *EIR*, Putin's visit was tantamount to saying to Washington: If you want to start a war against Iran, then you have to reckon with me, and that means, with Russia, a nuclear superpower. Perhaps not coincidentally, Putin right after his return to Moscow, stated in a worldwide webcast press interview, that his nation was developing new nuclear capabilities. His Iran visit was, as one Arab diplomat told *EIR*, a message to the warmongers in Washington, that Russia is still (or again) a superpower, and is treating the Iran dossier as a test for its status as a great power.

The Caspian Sea summit was, in and of itself, productive. Although the legal status governing the sharing of the sea's resources, was not solved, the points agreed upon in the final document of the summit constitute a great step forward in cooperation among the participating countries. Most important, the summit explicitly rejected the possibility that any one of its countries could be used for mounting aggressive acts against Iran, or any other country. It also explicitly endorsed the right of all countries to the peaceful use of nuclear energy. There was no mention of "concerns in the international community" about possible military applications of Tehran's program, or the like.

Putin's main point, which he reiterated at every possible

opportunity, was: Conflicts can and must be solved through diplomatic, peaceful means. In his address to the summit on Oct. 16, Putin praised the Caspian Sea countries' problem-solving formulae, "respecting each other's interests and sovereignty, and refraining not only from any use of force whatsoever, but even from mentioning the use of force." Putin went on to explain: "This is very important, as it is also important that we talk about the impossibility of allowing our own territory to be used by other countries in the event of aggression or any military actions against any one of the Caspian littoral states." In short: The U.S. cannot count on Azerbaijan, as a launching pad for operations against Iran.

The final document also announced the decision to form a Caspian Sea cooperation organization.

But, even more important than the summit itself, were the bilateral meetings that Putin held with Iran's President, and the Supreme Leader, who is the ultimate authority in the country. Ayatollah Khamenei does not routinely receive foreign visitors, thus his meeting with the Russian President took on a special significance. Putin reportedly presented Khamenei with a proposal for reaching a solution to the conflict over Iran's nuclear program. According to the Iranian state news agency IRNA, Khamenei told Putin: "We will ponder your words and proposal."

Although details of the proposal have not been made public, some news outlets reported that Iranian "hardliners" had said the proposal called for a "time-out" on UN sanctions if Iran were to suspend uranium enrichment. "The main reason for Putin's visit to Iran was to convey this message personally to the ultimate power in Iran," one Iranian official was quoted as saying. Khamenei reportedly told Putin that Iran was serious about continuing its nuclear energy program, including enrichment, but was not interested in "adventurism." If Putin did propose a "time-out," that would be coherent with what International Atomic Energy Agency (IAEA) director Mohammad ElBaradei has been campaigning for. It may be that Moscow's offer went beyond that of the IAEA chief.

The *Tehran Times* reported that Ali Larijani, head of the Supreme National Security Council and chief negotiator on the nuclear issue, told reporters that Putin had made a "special proposal," and that Khamenei said it was "ponderable."

According to a well-informed Iranian source who spoke with *EIR*, Tehran would be willing to suspend its enrichment program, on condition that it received something tangible in return. This would be a significant shift, since Iran has, to date, refused any such idea. Iran would *not*, however, be willing to give up its nuclear program, as North Korea has done. Suspension of enrichment activities would be temporary, in order to facilitate negotiations, which should be oriented towards tangible results, said this source.

At the same time, Russia's state radio RUVR reported on Oct. 16, that Putin proposed that the so-called North Korean recipe be used to settle Iran's nuclear problem. But what he



meant was perhaps not the same recipe in formal terms. His remarks were reported just before his meeting with Ahmadinejad. Putin argued, convincingly, that U.S. threats to use armed force against North Korea had proven futile. Such threats would hardly prove efficient with regard to Iran either, he said. Trying to frighten anyone, the Iranian leaders in this case, Putin said, is a waste of time. "They are not afraid, believe me." What should be done, he continued, is to arm oneself with patience and search for a settlement. But this is hardly possible without a dialogue with the people of Iran and Iran's leadership. If we do have a chance to maintain direct contact, we shall do it in a bid to achieve a positive joint, let me stress it, joint result, the Russian leader said in conclusion. Thus, Putin may not have been proposing that an approach be adopted exactly like that used for North Korea—which, had already tested a nuclear weapon—but that the diplomatic process used with Korea also be used with Iran.

### **Strategic Understanding Between Tehran and Moscow**

Whatever was agreed upon behind the scenes between Putin and his high-ranking Iranian counterparts, the official, rather extraordinary bilateral statement which was released after their talks, speaks volumes about Russia's commitment to a peaceful solution to the Iran crisis.

The joint statement, as reported by Itar-Tass on Oct. 17, was not just a list of points of agreement, but, taken as a whole, constitutes a far-reaching commitment by both sides, to strengthen what has become a strategic understanding between Moscow and Tehran, clearly oriented towards a war-avoidance policy. The statement begins with the assertion that, "The sides confirmed that mutually beneficial cooperation in the political, economic, cultural and other areas, as well as cooperation on the international stage, meet the national interests of the two sides and play an important role in supporting peace and stability in the region and beyond."

Economic cooperation is central in this regard, especially as concerns the energy sector: "The sides spoke in favor of increasing efforts to further expand economic ties between the two countries, especially in areas like the oil and gas, nuclear power, electricity, processing and aircraft-building industries, banking and transport."

As for nuclear energy—the issue being manipulated as a pretext for war—the statement says: "The sides noted bilateral cooperation in the area of peaceful nuclear energy and

confirmed that it will continue in full compliance with the requirements of the Treaty on the Non-Proliferation of Nuclear Weapons. In this regard they also noted that the construction and launch of the Bushehr nuclear power plant will be carried out in accordance with the agreed timetable." (Russia is helping to build the plant in Iran.)

In addition, the joint statement noted a contract for five Tu-204-100 aircraft to be supplied to Iran, as well as the need to create the conditions for advancing joint investment in Russia and Iran. Regarding regional infrastructure projects, the statement asserted the agreement "to continue work on the development of the north-south international transport corridor, including its automobile, rail and maritime components, in the interest of further strengthening trade and economic ties between Russia and Iran, as well as other countries of the region."

The two sides also reached agreement on "pressing regional problems," and stressed cooperation to achieve stability and security in Central Asia. Here the role of the Shanghai Cooperation Organization, of which Russia is a member and Iran is an observer, was highlighted.

As for the Caspian Sea region, the statement asserts that "the relevant norms of the agreements of 1921 and 1940 between Iran and the former Soviet Union remain in force until there is a convention on the legal status of the Caspian Sea." Furthermore, the two sides "advocate the exclusion from the Caspian region of military presence of non-Caspian littoral states," a clear rejection of any U.S. intentions to establish a presence in the region.

The joint statement also identified an identity of views on crucial foreign policy issues. They called for "building a fairer and more democratic world order which would ensure global and regional security and create favorable conditions for stable development ... based on collective principles and the supremacy of international law with the United Nations Organization playing a central coordinating role. ..." They explicitly ruled out Cheney-style saber-rattling: "The sides confirmed their refusal to use force or threat of force to resolve contentious issues, and their respect for sovereignty and territorial integrity of the states."

In the context of statements of their commitment to fight terrorism, the two sides also addressed the deteriorating situation in Afghanistan, and "confirmed Russia's and Iran's intention to continue to take part in the post-war reconstruction of Afghanistan, and are interested in strengthening its statehood and the process of that country becoming a peaceful, democratic, independent and flourishing state."

Iraq was also an important feature of the agreement. The two sides "expressed vigorous support for Iraq's territorial integrity and sovereignty and for an end to foreign military presence in that country on the basis of the relevant schedule." It should be noted that Putin, in his international webcast on his return to Moscow, made this a central point of his polemic against Washington.

To reach us on the Web:  
[www.larouche.com](http://www.larouche.com)

Finally, in a short but clear paragraph, the two “noted the need to settle the issue of Iran’s nuclear program as soon as possible by political and diplomatic means through talks and dialogue and expressed hope that a long-term comprehensive solution will be found.”

In sum, the joint statement goes far beyond any earlier definition of relations between Russia and Iran, and sends a clear message to the war party in Washington and London, that they can no longer consider Iran in isolation, but must recognize that the country has become a strategic partner of Russia, whose leadership is determined to prevent war.

### Europeans Should Know Better

What Putin achieved in Tehran must have sent shivers up and down the spines of Cheney and his sympathizers at home and in Europe. President Bush indulged in one of his typical ranting sessions Oct. 18, in remarks to the press, in which he threatened that were Iran to achieve the knowledge required to build a bomb, then that would mean World War III were just around the corner. In Europe, members of the coalition of the spineless had already weighed in against Putin, even attempting to dissuade the Russian leader from going to Iran. U.S. Defense Secretary Robert Gates and Secretary of State Condoleezza Rice pressured Putin, during their Moscow visit, to join them in threatening Iran with new sanctions, if it did not meet their expectations on the nuclear issue. French President Nicolas Sarkozy had delivered a similar message. During his visit to Wiesbaden, Germany, for the Petersburg Dialogue, on Oct. 14-15, Putin was again besieged by German Chancellor Angela Merkel and others, with demands that he get tough with Tehran.

And, in case the message had not registered, a wild story was circulated internationally, that a team of suicide bombers was primed to blow themselves and Putin up, as soon as he set foot on Iranian soil. While Iranian officials denounced the obvious psywar attributed to “foreign” intelligence services, Putin tossed the story off with a laugh, saying, were he to heed such warnings, he would never leave his home.

The point to be made is that Putin—unlike his European interlocutors—has grasped the fact that what the Cheney crowd is threatening is world war, not some political power play, and has therefore stuck to his guns. That Russia has been aware of the dangers inherent in Cheney’s planned Iran war, is nothing new. In his speech to the Munich Wehrkunde meeting early in 2007, Putin had lashed out in most undiplomatic terms, against the pretensions of the would-be leader of a presumed unipolar world, to dictate world affairs through military fiat. And, regarding the Iranian nuclear issue, Russia has been consistent in stating its position that 1) if Iran abides by international commitments to the NPT and IAEA regime, then 2) Iran’s right to the peaceful use of nuclear technology must be guaranteed, and 3) that program must not be misconstrued as a weapons program, and thus used as a pretext for military aggression.

# Are Israel and Syria Holding Peace Talks?

by Dean Andromidas

Are Israel and Syria holding back-channel peace talks? As far-fetched as this may sound, this is the real question to be asked today in the Middle East. On Sept. 18, and again on Sept. 26, Lyndon LaRouche issued a statement supporting Israeli President Shimon Peres’s call for Israel to hold peace talks with Syria, as key to begin transforming the disastrous situation throughout Southwest Asia (See “LaRouche Backs Peres on Peace Talks With Syria,” *EIR*, Oct. 5). Since those calls, diplomatic developments and statements by Syrian and Israeli officials indicate that something is happening behind the scenes between the two countries.

These developments follow ongoing moves by Vice President Dick Cheney to start another war in the region against Iran, Syria, or both. Cheney and his neoconservative cronies have made it clear to Israel that they will not tolerate an Israeli-Syrian peace process. They have seized on the mysterious Sept. 6 air strike by Israel against an unknown target in Syria, to claim that Syria has an undeclared nuclear program, a charge calculated to set up Syria for further attacks by Israel or the United States.

To counter Cheney’s moves, it appears that both Israel and Syria have recruited Turkey to mediate talks between them.

On Oct. 11, in an interview with the Tunisian daily *Al Shuruq*, Syrian President Bashar Assad revealed that Turkish officials have been making frequent visits to Damascus in ongoing efforts to prepare the ground for Israel-Syria talks. Although he said that Syria is unlikely to attend the Bush Administration’s peace conference in November, because its details remain vague, Assad reiterated his position that Syria expects negotiations to be held under U.S. auspices and participation, and that the Golan Heights would be restored to Syria.

“In order for the Turkish mediation to succeed,” Assad told the daily, it requires “a godfather who has weight in the international arena, and which can only be, if you like it or not, the United States. But until that negotiation is possible, a Turkish mediation can play a positive role. That is what Turkey is trying to do.” As for Israel, Assad said, “All we want is a clear declaration by Israeli officials of their desire for peace and the return of [occupied] land to Syria.”

The next day, at least one Israeli official made a statement in the spirit of Assad’s request: Outgoing Israeli Army Deputy Chief of Staff, Gen. Moshe Kaplinsky, in an interview that appeared on Israel’s Channel 10 television station, called for Israel to hold a dialogue with Syria as a crucial means of lower-

ing tensions between the two countries. He said, in part, “I think it is of great interest to the state of Israel and the West as a whole, to take Syria out of this axis [with Iran], and according to my understanding, this is possible. If the conditions are created, it can be done.”

This was not just a coincidence. On Oct. 5, Turkish Foreign Minister Ali Babacan was in Damascus, where he met President Assad, after which he visited Israel, where he told Israeli Prime Minister Ehud Olmert and Israeli President Shimon Peres that Syria was ready for peace talks. After meeting Israeli President Peres, Babacan said, “I encouraged the [Syrian] leaders to take part in Bush’s international conference, and they told me clearly that Syria was interested in the Israeli-Syrian issue also being on the negotiating table.”

Baracan also demanded from Israel details on its mysterious Sept. 6 air strike on Syria; Turkey had discovered on its territory Israeli fuel tanks that had obviously been dropped by the Israeli attack aircraft. “The area is currently in a very dangerous and delicate state. We are calling on all sides to reach a solution [to their grievances] through dialogue and other peaceful means,” Baracan said. “Turkey will not let Turkish territory or airspace be used in any activity that could harm the security or safety of Syria.”

In his meeting with Olmert, Babacan made a similar statement: “Syria is ready for dialogue and should not be isolated. There must be a way to negotiate with them. The only reason why Syria is allied with Iran is the international boycott that has been imposed on it,” Babacan said.

### **To Save Peace Summit, Rice Needs Assad**

Although neither Peres nor Olmert responded positively, at least not in public, there is a strong peace lobby in the highest levels of the Israeli Defense Force. An Oct. 16 commentary by Amir Oren, security correspondent for the Israeli daily *Ha’aretz*, alludes directly to such military support. He tells U.S. Secretary of State Condoleezza Rice that if she hopes to have any success in the November peace conference, “especially productive can be the inclusion of Syria in the conference.” Oren writes, “President Bashar Assad’s announcement that he will not come to the conference if there is no discussion on the Golan Heights caused Jerusalem to sigh in relief, instead of sounding positive with a call to restore at Annapolis negotiations with Syria.”

Pointing to the fact that there is support in the Israeli military for this, Oren says, “Real leadership aspiring to achieve peace would have jumped at the opportunity and would have used the support of the chief of staff and his advisors, the military intelligence chief, and other senior defense officers.” Even in the wake of the Sept. 6 Israeli air strike in Syria, negotiations could easily be resumed, Oren says. His commentary concludes, “To save Annapolis, Condoleezza Rice needs Assad.”

Several of the most senior officers in the Israeli Defense

Force, including Chief of Staff Gabi Ashkenazi, were involved in the Syrian-Israeli peace negotiations in 1999, when Ehud Barak was Prime Minister. An Israeli intelligence source told *EIR* that there is strong military support for Israeli-Syrian peace talks today, stronger even than in political circles.

On the same day that the Oren article appeared in *Ha’aretz*, President Assad told the Syrian State News Service (SANA), on the eve of his official visit to Turkey: “We have told them [the Turks] that our stance toward peace does not change. All we want is a clear declaration by Israeli officials of their desire for peace and the return of [occupied] land to Syria.”

### **Cheney Maneuvers for War**

Cheney is far from abandoning his designs for a broader war in the region. He and his cronies seized upon the Sept. 6 Israeli air strike against a still-unknown target in Syria, to beat the wardrums against Syria and North Korea for allegedly cooperating on an illegal nuclear program. Yet, Israel has kept total silence about the strike, admitting only that a strike occurred, but releasing no other information. Assad said only that the Israelis struck an unused military base and then beat a hasty retreat.

Cheney’s top neocon ally, former United Nations Amb. John Bolton, from his bunker at the American Enterprise Institute in Washington, talked to anyone who would listen, about an alleged Syria-North Korea bomb plot. The story escalated just as North Korea agreed to give up its nuclear program, and after it had signed an historic agreement with South Korea for broad economic and political cooperation—a development that neither Cheney nor Bolton wanted.

The campaign peaked with an article in the Oct. 14 *New York Times*, which quoted unnamed sources and unsubstantiated allegations, on the role of Dick Cheney himself, leading a “debate” within the White House for the United States to support an Israeli strike against Syria.

The real character of this “exposé” was revealed by Prof. Joseph Palermo of California State University, Sacramento, who wrote in the online Huffington Post on Oct. 16, that the authors of the *Times* article, David Sanger and Mark Mazzetti, had cited 23 sources, 22 of whom were “unnamed” officials of the U.S. government. The 23rd source was White House spokeswoman Dana Perino.

Palermo, who has been writing about Cheney’s disinformation tactics for years, says that the leaks to the *Times* were designed to make the case for an Israeli preemptive strike on Syria, which would also help Cheney’s plans for a U.S. preemptive strike against Iran. Palermo called Sanger and Mazzetti the new “Judy Miller-Michael Gordon” team, doing the same Administration dirty work as Miller and Gordon had done earlier against Iraq and Iran, respectively.

On Oct. 15, the International Atomic Energy Agency (IAEA) called Cheney’s bluff by pointing out that any country

that has such evidence has an obligation to present it to the Agency. "The IAEA has no information about any undeclared nuclear facility in Syria and no information about recent reports. We would obviously investigate any relevant information coming our way. The IAEA secretariat expects any country having information about nuclear-related activities in another country to provide that information to the IAEA."

The IAEA is still waiting for that information.

Cheney is also moving to undermine Rice's feeble attempt to convene the Middle East peace conference in Annapolis, Maryland, provisionally set for some time in November. No sooner did Rice complete a tour of the region, where she met Olmert, Palestinian President Abu Mazen (Mahmoud Abbas), Egyptian President Hosni Mubarak, and Jordanian King Abdullah III, than the White House announced that National Security Advisor Stephen Hadley, and his deputy for the Middle East, Elliott Abrams, will soon travel to Israel and the Palestinian National Authority. Abrams is Cheney's number-one ally, and represents Cheney's hardline position on the National Security Council and the White House staff. His arrival will signal to the region an attempt to undo everything Rice tried to do.

This fact will not go unnoticed in Israel, where, even before the White House announcement, Akiva Eldar wrote in a commentary in *Ha'aretz* Oct. 16: "Elliott Abrams, who is in charge of the National Security Council's Middle Eastern Affairs, holds that negotiations with the Palestinians on a final status solution is an idiotic idea. Members of the other camp, headed by Rice, believe the time has come to renew the peace process, but they have no idea how to go about this. . . ."

Given the role of Cheney, both the Israeli and Palestinian peace camps see the proposed conference as a disaster waiting to happen. Yossi Beilin, chairman of the Israeli Meretz-Yahad party, was in Washington to hold meetings with U.S. Undersecretary of State for Political Affairs Nick Burns and Deputy National Security Advisor Jim Jeffrey. Ynet quoted Beilin as saying that the Americans were "creating a situation wherein failure in Annapolis may lead to disaster. It would have been possible for bilateral talks between Prime Minister Ehud Olmert and Palestinian President Mahmoud Abbas to continue. If, after seven years of no negotiations at all, this summit fails, it could truly bring about catastrophe." Failure, Beilin told Ynet, would also spell the end of Abbas's rule and "give an unbelievable boost to Hamas's strength."

The only way to save the conference, Beilin told Ynet, was for both sides to achieve something significant. "My message is that we did not ask for the Annapolis conference, but if you wanted it, then it is your [America's] responsibility. It is up to you, along with Israel and the Palestinians of course, to prevent Annapolis from becoming" a disaster.

In his Sept. 26 call for Syria-Israel peace talks, LaRouche said that unlike Rice's proposed conference, which nobody wants anyway, a Syria-Israel deal would "open up the door for other things" that would break this "damned stalemate," and open the way for a partnership between Israel, Syria, and other countries in the region for a "war-proof design for nuclear desalination" that will make possible a regional economic peace-through-development program.

If Israel is not involved in back-channel talks, it certainly should be.

## Former Mossad Chief: Iran Not an Existential Threat

While George W. Bush is raving that a nuclear Iran is a threat to the existence of Israel and could lead to World War III, former chief of the Israeli Mossad intelligence agency, Ephraim Halevy, declared the very opposite.

Speaking at a Lauder Institute conference in Jerusalem on Oct. 17, Halevy said: "All the problems Israel had were not the result of unidentified threats. Iran must be dealt with in two simultaneous ways: They must be pressured through the global economy, and they must be given an opportunity to talk once they change their ways."

Declaring that Iran cannot destroy Israel, Halevy stated: "We cannot say that the Iranian threat is an existential threat on the State of Israel. I believe that the State of Israel cannot

be eliminated. It cannot be destroyed because of things you know and because of things you can imagine." The latter is an obvious reference to the fact that it is Israel that has nuclear weapons, and could pose an existential threat to Iran if Iran were to try to attack Israel.

As for Iranian President Mahmoud Ahmadinejad, Halevy said sarcastically: "Had he not existed, we would have had to create him. He is doing great things for us."

Addressing Israel's activity in the face of the Iranian nuclear program, Halevy stated: "You should assume that things have been done and things are being done, and assume that the Jewish mind can create amazing things. Iran is a bitter enemy, but this does not mean that it should be an enemy forever. The situation in Iran has not been particularly good over the past year. The economic situation is worsening, there is a 30% inflation, an official unemployment of 25%, and in Tehran, the unemployment rate is 50%. Those who elected Ahmadinejad President did not elect him to develop nuclear weapons, but rather to serve as a successful mayor in Tehran."

# Spotlight on Bering Strait At Arctic Energy Summit

by Marcia Merry Baker and Anita Gallagher

“Even as we stand here, machines are building our part of the World Link,” declared Alexander Sergeev, member of the Executive Board of RusHydro energy company, to the Arctic Energy Summit Technology Conference held Oct. 15-18 in Anchorage, Alaska. The building of the multimodal Bering Strait Tunnel-Rail link between Russia and the United States—a project long championed by American statesman Lyndon LaRouche—was put forward as the “live” question before conference participants. It is, as well, a live question before Americans: Will the United States accept Russia’s offer to jointly build it?

The Arctic Energy Summit, organized by the Institute of the North, founded by former Alaska governor and Bering Strait tunnel promoter Walter J. Hickel, was co-sponsored by the U.S. State Department and the Arctic Council (of eight Arctic nations), and billed by its organizers as “The premier energy conference of the International Polar Year” (2007-09). Speakers included Yevgeni Velikhov, head of Russia’s Kurchatov Institute; Alexander Sergeev; George Koumal, head of the Interhemispheric Bering Strait Tunnel and Rail Group (IBSTRG); representatives of the nations that border the Arctic, including the President of Iceland, Olafur Ragnald Grimsson; Canada’s Minister of Natural Resources, Gary Lunn; U.S. Assistant Secretary of State Dan Sullivan; energy experts from the Russian Federation, Iceland, Norway, Sweden, Finland, and Canada; British Petroleum; the Global Infrastructure Fund Director, Nomuri Yamamoto; and many officials from Alaska, Chukotka, and Sakha. Alaska Gov. Sarah Palin, and Sens. Lisa Murkowski and Ted Stevens addressed the gathering.

The idea of transforming the Earth through great projects of physical economy, and transforming the Earth’s raw materials through the most advanced technologies, as advocated by the great Russian scientist V.I. Vernadsky, was presented

with great passion by the Russian delegates. The concepts they presented broke like giant waves on the shore of the conference, and reduced other conference tracks, such as the ubiquitous “alterative energies,” to an insidious undertow; for example, U.S. Assistant Secretary of State Dan Sullivan’s promotion of a United States-Brazil special deal for sugarcane biofuels.

## Russians Say ‘Go Nuclear’

On the first day, Russian Academician Velikhov made a powerful case that the way to develop the Arctic is to “go nuclear.” Nuclear power in the Arctic is what’s essential, Velikhov said in his plenary session address. He told the audience that his great-grandfather had worked in shipbuilding at the giant Sevmas plant at Severodvinsk, in the Russian North, near the Arctic Circle, and that nuclear ships for ice-breaking are essential. It is also necessary, Velikhov said, to have high platforms from which to drill, and it takes a nuclear base to produce them. And, he noted, electromagnetic data is needed to find new deposits of hydrocarbons.

The Russian presentations gripped the audience because the speakers emphasized Russia’s intention to proceed with this “world link.” In a press briefing on the afternoon of Oct. 15, Velikhov, Sergeev, and Lev M. Shtilman, advisor to the governor of Chukotka, upped the ante by reporting on these developments and plans, speaking along with IBSTRG officials Koumal and Craig Burroughs:

- Academician Velikhov declared that nuclear mini-plants will play a key role in building this link. They will be produced as mobile units that can be transported to wherever they are needed by trucks, rail, or floated into position. Velikhov’s statement was fiery on the need for nuclear power, and for high-technology versions of everything.

To stress this point in his plenary speech, he used many

graphics, which are being archived at [www.arcticportal.org](http://www.arcticportal.org). On Oct. 16, Velikhov explicitly addressed the “energy gap” between current world supply and worldwide demand. Sticking with the current dependence on oil, gas, and so forth, will not work; there must be nuclear power.

• Alexander Sergeyev of RusHydro, the second largest hydro-energy producer in the world, stated dramatically, “Even while we’re standing here,” there are machines at work in Russia providing hydro-electricity for the expansion of the rail lines. He announced that Oct. 19, the Bureyskaya Hydro-electric Power Station in Russia’s Far East goes operational at its full, 2,000 MW capacity, after the final testing of the dam’s sixth unit, and the upgrading of previously built sections. Sergeyev also reported on the Russian government’s Sept. 6 approval of the plan for expansion of rail lines across the nation, for the period ending 2030.

Sergeyev also announced that Russia can provide \$20 billion, or one-third, of the total funding needed for the rail line in Russia, the Bering Strait Tunnel, and 2,000 km of rail from the Seward Peninsula to British Columbia, as well as the 150 km of the tunnel itself—so, what is needed, is to find the remaining \$50 billion. George Koumal, president of the IBSTRG, announced that this \$50 billion could come from private interests, if the project gets the needed government commitment.

The local NBC-TV affiliate in Anchorage showed footage of the press conference, where it was announced that the tunnel will be drilled from both sides, and the Russian and American teams will meet in its center for a vodka toast.

## The Franklin Roosevelt Precedent

In his speech on Oct. 16 on “The Role of the World Link [global rail corridor network] in the Development of Arctic Energy Resources,” Alexander Sergeyev dwelled on the legacy of Franklin Delano Roosevelt. The Russians are studying Roosevelt, he said, because it was under his Presidency, during the 1930s Depression, when great projects were constructed—such as the Hoover Dam, and the expansion of railroads in America.

It is clear that “the ducks are being lined up” behind the Bering Strait project, which had been the subject of a high-profile conference in Moscow last April. At the Oct. 15 press conference, the speakers reported they had visited the site at Wales, Alaska, where the tunnel entrance would be.

The political and social prerequisites for the project are also underway. The IBSTRG is committed to promoting more high-level dialogue, and also intends to formulate a “compact” that could be signed by Russia, the U.S.A., and Canada.

Besides the “deep interest” shown by U.S. Sen. Lisa Murkowski (R-Ak.), and the U.S. State Department, which the IBSTRG press release reports, it also announced that the project is supported by Gov. Sarah Palin (R-Ak.), and Denise Michels, the Mayor of Nome (the city closest to the tunnel site). The release also announced that discussions had been held

with the administration of the village of Wales, the Alaskan entry-exit point, and representatives of the Alaska Native Corporation, and that “the native people have supported the idea of creating the Bering Strait Tunnel, which will contribute to the region’s economic growth, and create more workplaces.”

On Oct. 16, *EIR* Economics intelligence director Marcia Merry Baker asked Koumal how the current world financial crash might affect the prospects for financing the Bering Strait project, and noted Lyndon LaRouche’s long-standing support for this project, as well as LaRouche’s ongoing efforts to prevent the collapse from stopping necessary “Great Projects” like this one. Koumal responded that the economy needs “something that matters” to hold itself up, and that the economy could collapse if overloaded with “please ourselves” kinds of activities. The statement reflected the moral idea of mankind’s role in continuing the Creator’s work, by making and applying scientific discoveries for progress.

At a Bering Strait tunnel presentation the next day, a youth asked Koumal how long it would take to build the entire World Link, from the tip of South America to the tip of Africa. Someone who had worked on the Chunnel (the tunnel under the English Channel, connecting England and France), said that it took five years in total, and that it was a more difficult undertaking. Koumal, in response to another question, came out for magnetically levitated trains in population-dense areas.

In an interview with *EIR*, a Russian energy expert from Chukotka described the drop in the province’s population, from 100,000 to 60,000 over the last decades, but now the commitment is to expand the economy and living standards and the rail and tunnel. There is a plan to place a floating nuclear plant in Chaun Bay with a deadline of 2012, which will be the second one, after the first is placed in the European Arctic.

## ‘Why War? Why Not Big Projects?’

Former Alaska Gov. Walter Hickel continued the powerful theme of optimism in his address to the Oct. 17 Awards Banquet of the Summit. Hickel told the 200-person audience, “We can work together on great projects.” There is a lot of talk at the United Nations, but to put it straightforwardly, “To build a new world, we must build it. . . .” He posed the question, “Why war? Why not big projects? . . . The price of freedom must be sweat, not blood. . . . In some quarters, big projects are not politically correct. . . . But if God didn’t like the world, he wouldn’t have created the universe.” Hickel then presented the audience with five “Great Projects”: A global energy program to provide electricity to the 2 billion people who today lack it; the Bering Strait Project, of which he said, “That tunnel will happen!”; the opening of the Northern Sea Route, which, he said, could be the new Panama Canal; a solution to the global water crisis, built on harnessing the water from seven of the world’s largest rivers that run northward; and to “harvest the energy of the North,” rather than lock it up.

*EIR* will provide full coverage of this conference in November.

# Dick Cheney's Oil Law for Iraq Is Neo-Colonial Theft

by Muriel Mirak-Weissbach

President George W. Bush has defined passage of the Iraqi Oil Law by Iraq's Parliament as one of the "benchmarks" that must be met, in order for Iraq to prove itself ready for self-rule. The Bush Administration worked on this bill for more than four years; it was promoted as a step toward unifying Iraq, assuring the fair geographical distribution of oil revenues. But in fact, as Iraqis are increasingly aware, it is a way of permanently colonizing their country to Big Oil. While the Cabinet approved the bill in February, opposition is growing, and Parliament has not passed it, despite intense pressure from President Bush, U.S. Ambassador Ryan Crocker, and others.

Nowhere has Washington made details of the bill public. Instead, its contents have been made available only through press leaks.<sup>1</sup>

The key component of the fraud perpetrated by the draft oil law, is what is known as a Production Sharing Agreement (PSA)—even though the term is not explicitly used.

What is a PSA? Gregg Muttitt, of PLATFORM, was the first to blow the whistle on PSAs in a November 2005 article, entitled "Crude Designs: The Rip-Off of Iraq's Oil Wealth"<sup>2</sup> The PSA emerged in the 1960s, in Indonesia, he explained. "Whereas in a concession system," as was common in the colonial era, "foreign companies have rights to the oil in the ground, and compensate host states for taking their resources (via royalties and taxes), a PSA leaves the oil legally in the hands of the state, while the foreign companies are compensated for their investment in oil production infrastructure and for the risks that they have taken in doing so." The company which invests to explore, drill, and produce, uses its oil sales to recoup these investments, known as "cost oil." After covering these costs, the company reaps "profit oil," which it divides with the country, according to contract.

As Muttitt explains, there are a number of serious disadvantages to Iraq in such PSAs. "They fix terms for 25-40 years, preventing future governments from changing the contract. . . . Secondly, they deprive governments of control over

the development of their oil industry. . . . Thirdly, they generally over-ride any future legislation that compromises company profitability, effectively limiting the government's ability to regulate. . . . Fourthly, PSAs commonly specify that any disputes between the government and foreign companies are resolved not in national courts, but in international arbitration tribunals which will not consider the Iraqi public interest."

Iraq, which holds the third largest oil reserves in the world, has 115 billion barrels of known reserves, and is thought to have a whopping 100-200 billion barrels of undiscovered reserves. According to figures released by the Iraqi Oil Ministry in March 1995, when Saddam Hussein was still in power, there were 25 Iraqi oil fields categorized as "undeveloped," which were slated for development, once sanctions were lifted.

Other big oil producers, from U.S. allies Saudi Arabia and Kuwait, to designated enemy Iran, have rejected PSAs, by constitution and national law. If this law is imposed on Iraq, it will signify a dramatic shift in the country's traditional oil policy; as Muttitt notes, the oil industry has been public in Iraq since 1972, and the rights to develop oil in 99.5% of the national territory had been in public control since 1961.

## The Devil in the Detail

The oil law, governed by the concept of the PSA, permits foreign intervention in all relevant Iraqi institutions:

- The Preamble specifies that "the rehabilitation and further development of the Petroleum industry will be enhanced by the participation of *international* and national investors. . ." (emphasis added).
- Article 5 introduces the most crucial new institution, the Federal Oil and Gas Council. This FOGC, to be created by the Council of Ministers, will be presided over by "the Prime Minister or his nominee, and will include Iraqi regional and national officials, as well as international players: "To assist" the FOGC in "reviewing Exploration and Production contracts and Petroleum Fields' Development plans, the Council relies on the assistance of a panel called the 'Panel of Independent Advisors' that includes oil and gas experts, Iraqis *or foreigners*" (emphasis added).

As for the "discovered but not yet developed fields," "it is permissible to develop these Fields in collaboration with *reputable oil companies* that have the efficient financial, administrative, technical, operational capabilities according to the contracting terms and the regulations issued by the Federal

1. First was an item published on [www.al-ghad.org](http://www.al-ghad.org) by Prof. Fouad Al-Ameer, picked up then by [www.niqash.org](http://www.niqash.org), and then by Iraqi blogger Raed Jarrar, who translated an Arabic version into English. See [www.box.net/public/ehdz113d71](http://www.box.net/public/ehdz113d71), which gives the link to [IraqiOilLawRaedJarrar.pdf](#).

2. [www.globalpolicy.org/security/oil/2005/crudedesigns.pdf](http://www.globalpolicy.org/security/oil/2005/crudedesigns.pdf).



U.S. Centcom

*Capping an extinguished oil well in Ramaylah, Iraq. Many Iraqis rightly view the proposed oil law as theft of their resources, and their national sovereignty.*

Oil and Gas Council” (emphasis added).

- Article 9 specifies that “rights for conducting Petroleum Operations shall be granted on the basis of an Exploration and Production contract . . . between the Ministry (or the Regional Authority) and an Iraqi or Foreign Person, natural or legal. . .” (emphasis added).

(The reference to the rights of the Regional Authority to sign contracts is very important. Although it goes beyond the bounds of our treatment here (and will be dealt with in an upcoming article), such powers given the Regional Authorities have made it possible for the Kurdish region to make independent deals with numerous foreign oil companies. Thus have the centrifugal tendencies in that region, toward establishing an independent “Kurdistan,” been encouraged.)

- In Article 13, the colonialist nature of the operation becomes clear. First, “An Exploration and Production Contract shall give the holder an exclusive right to conduct Petroleum Exploration and production in the Contract Area.” Once a discovery has been made, the Iraq National Oil Company (INOC) “and other holders of an Exploration and Production right may retain the exclusive right to develop and produce Petroleum within the limits of a Development and Production Area for a period to be determined by the Federal Oil and Gas Council varying from fifteen (15) to twenty (20) years”!

## Made in U.S.A./Britain

It should come as no surprise that the oil law was not an Iraqi invention. It was concocted in the United States, and long before the bombs started falling on Baghdad. Dick Cheney, in his incarnation as executive of Halliburton, back in 1999, told the Institute of Petroleum in London: “By 2010 we will need on the order of an additional 50 million barrels a day. So where is this oil going to come from? . . . While many

regions of the world offer great oil opportunities, the Middle East with two-thirds of the world’s oil and the lowest cost is still where the prize ultimately lies.”

As documented by Ed Spannaus in *EIR* (Sept. 12, 2003), Cheney and Co. had detailed plans for seizing Iraqi oil after the war.<sup>3</sup> Cheney’s Energy Task Force came out with a report specifying that the Persian Gulf region, with 67% of proven world oil reserves, “will remain vital to U.S. interests.” The Task Force secretly developed a map, showing precisely where Iraq’s oil fields were, where the refineries and terminals were located, and what projects were already on the agenda for oil and gas, including a list of “Foreign Suitors for Iraqi Oil Field Contracts.”

There were a number of initiatives launched by the Bush-Cheney Administration, to secure control over Iraq’s oil. For example, Bush signed Executive Order 13303 on May 22, 2003, which granted U.S. oil companies and contractors immunity from any complaints dealing with Iraqi oil. Yet, even such imperial decrees could not guarantee full protection from international law. Thus, the need to put through a law in Iraq itself.

Further aspects of the U.S. involvement in Iraq’s oil law are noted in an extremely useful chronology of events compiled by The Center for Grassroots Oversight.<sup>4</sup> In April 2003, the State Department’s Oil and Energy Working Group explicitly endorsed PSAs as a formula which would protect the oil companies from changes under future governments. In that same month, the U.S. dispatched hundreds of economic advisors to work with the ministries of the occupation government. In September 2003, then-Prime Minister Iyad Allawi made recommendations to the Supreme Council for Oil Policy: PSAs should be applied to development of all fields other than those already in production. This meant that 17 of 80 known fields would be under government control, the rest to be given over to the private sector—as later enshrined in the oil law. In March 2004, two former oil industry executives were named as advisors to Iraq’s oil ministry: Mike Stinson of ConocoPhillips and Bob Morgan of BP. In June 2004, the Minister of Oil was Thamir al-Ghadban, a British-trained oil engineer. Several Iraqi politicians weighed in on the side of oil privatization, including the infamous Ahmad Chalabi (who had provided Cheney with fabricated “intelligence” on Iraq’s alleged weapons of mass destruction), in November 2005; and Hussein al-Shahristani, the new Oil Minister, who spoke in May 2006 of the “need to pass an oil and gas law to guarantee the right conditions for international companies to help develop the Iraqi oil sector.”

In the middle of 2006, Ronald Jonkers, a D.C. lawyer, was dispatched to Iraq to work on the new law. By July the first

3. [www.larouchepub.com/other/2003/3035cheney\\_cptbggrs.html](http://www.larouchepub.com/other/2003/3035cheney_cptbggrs.html).

4. [www.historycommons.org/timeline.jsp?timeline=us\\_occupation\\_of\\_iraq\\_tm1n\\_specific\\_issues=us\\_occupation\\_of\\_iraq\\_tm1n](http://www.historycommons.org/timeline.jsp?timeline=us_occupation_of_iraq_tm1n_specific_issues=us_occupation_of_iraq_tm1n).



draft was ready, as worked out by Iraqis Tariq Sharif, Farouk al-Qassem, and Thamir al-Ghadban, and it contained the PSAs as a leading feature. The U.S. government and nine oil companies then reviewed the draft in July, after which U.S. Energy Secretary Samuel Bodman went to Baghdad, and urged politicians to “pass a new law, a new hydrocarbon law under which international companies will be able to make investments in Iraq.” The International Monetary Fund, not to be left out, reviewed the draft in September.

On Jan. 16, 2007, the Iraq Oil Committee approved the draft, followed by the Cabinet, which gave its okay on Feb. 26. At that point, the only entities which had read the text, aside from its ostensible authors and the Iraqi Cabinet, were the IMF, the oil multinationals, and the British and U.S. governments. Then, a committee of political figures from Iraq’s different ethnic/sectarian groups convened to discuss the law, and presumably finally had a chance to look at the carefully guarded text. At that point, conflict broke out among different groups regarding the alleged sharing of oil among them. The Iraqi Parliament, not to mention the broader public, were still in the dark. As soon as the light dawned on them, all Hell broke loose.

### **Iraqis Mobilize Against the Sellout**

Anyone who has visited Iraq, knows that a people with thousands of years of history, does not readily relinquish its national identity, its independence, and its sovereignty. The growing resistance to the sellout of the country’s natural resources, is an indication of this.

The resistance to the oil law has come from many sectors of Iraqi society: intellectuals, oil workers, politicians, and others. The first major sign of resistance appeared in February, when the head of the Federation of Oil Unions in Basra, Hasan Jum’ah ’Awwad al-Asadi, denounced the draft law, on grounds that Iraq needed no outside “help” to produce oil. He cited the fact that oil workers had proven able to restart production after the devastating war “without any foreign expertise or foreign capital.” On Feb. 8, the oil labor unions sent a letter to President Jalal Talabani, telling him he should reject any law based on PSAs, which, they said, were “a relic of the 1960s.” The oil workers went on strike in Basra on June 4. Al-Asadi, speaking for his 26,000-worker union, called for a role in drafting the law, saying the existing draft gave foreign companies too much control.

On June 18, Reuters reported on the U.S. tour of Faleh Abood Umara, general secretary of the Southern Oil Company Union and the Iraqi Federation of Oil Workers Union, who was telling crowds that the law was “a raid by the international oil cartel,” and that unions would mobilize to stop it. He said they would “take strong measures, even including stopping the flow of oil.”

Parliamentarians also balked at the bill. On July 4, one day after the Cabinet had approved an amended draft, leading Sunnis from the Iraqi Accordance Front, which had boycotted

votes on the bill, said no draft should be considered by the legislative body until its members returned. The Sunni Association of Muslim scholars forbade any vote on the bills. Even inside the government, protest was raised. Minister of Planning and Development Cooperation Ali Baban, told Voice of Iraq on July 20 that he would resign if the law passed without radical changes. He also called for “a referendum on this law, or distributing copies of the draft to all Iraqis to be aware of the bill’s articles.” Joining this protest was the bloc of radical Shi’ite leader Moqtadar al-Sadr, whose spokesman announced they would not support any law which would allow firms “whose governments are occupying” powers to sign oil deals. “The most serious problem with the law,” the spokesman quoted by AFP said, “is the production-sharing agreements, which we categorically reject.”

### **Opposition in the U.S.**

Inside the United States, it is lamentable that so few politicians have had the guts to oppose this atrocity. Rep. Dennis Kucinich (D-Ohio) has stood out as one exception. On May 23, Kucinich, who has been an opponent of the Iraq War, as well as of the threat of an Iran war, took to the floor of the House of Representatives in order to provoke a full discussion of the Iraq oil law. “Any attempt to sell Iraqi oil assets during the United States occupation,” he said in his bill HR 1234, “will be a significant stumbling block to peaceful resolution. There must be fairness in the distribution of oil resources in Iraq.”

On Sept. 18, Kucinich upped the ante, following news of an oil deal struck between the Hunt Oil Company of the U.S. and the Kurdistan Regional Government. Kucinich called for a Congressional investigation to determine what role the administration might have had in the deal, considering that the privately held oil company is based in Texas, and that its founder, Ray Hunt, is close to Cheney, as well as being a donor to Bush. The Congressman pointed out that the Hunt Oil deal also exposed the intent of Cheney’s Iraq oil law, to privatize the sector.

Kucinich has sent letters to Secretary of State Condoleezza Rice as well as Rep. Henry Waxman (D-Calif.), chairman of the House Oversight and Government Reform Committee, demanding the Hunt deal be examined. These initiatives are to be supported, but are unlikely to yield serious results as single initiatives. More important is Kucinich’s resolution HR. 333, which calls for the impeachment of Dick Cheney—a demand first raised in 2002 by Lyndon LaRouche. Ultimately, the only way to shift U.S. policy on Iraq from its current neo-imperial thrust, to a policy of cooperation among sovereign nations in the interest of regional, and world, peace, is to remove Cheney from power, now. The fact that Kucinich initiated the demand for impeachment in the House indicates his awareness of this as the top priority. When will his fellow Democrats, who claim to oppose the Administration’s war policy, finally stand up and join the impeachment drive?

# Colombian LaRouche Movement: Vote for Great Projects, Maglev

*The following leaflet, "Vote for the Darién Train and the Metro for Bogotá," was put out on Sept. 20 by Maximiliano Londoño as president of the LaRouche Association in Colombia, and by the Colombian chapter of the LaRouche Youth Movement (LYM), to intervene in the Oct. 28 national elections. The leaflet specifically addresses the race for mayor of Bogotá, in which Samuel Moreno is running as the candidate who favors a metropolitan train system for the capital city. The Moreno campaign decided to print 50,000 copies of this leaflet, which are now being circulated in Bogotá by mixed squads of LYM and Moreno campaign organizers. The leaflet was translated from Spanish for EIR.*

Only here in "Macondo" would there be discussion over whether there should be a Metro in Bogotá and whether Colombia should have electric trains and magnetic levitation trains, while in the rest of the world, nations are going ahead and simply building these great projects. The government of Japan has announced that it will abandon its bullet trains, which travel at more than 300 km an hour, because that technology is already obsolete, and will replace them with maglev trains that travel at more than 500 km an hour. The Russian government announced in April that Russia will build a tunnel under the Bering Strait, to connect the Eurasian continent with the Americas.

Thus, one would be able to travel in electric trains from Madrid, Spain, or any other European capital, across the entire European continent, follow the nearly 10,000 km of the Trans-Siberian Railroad in Russia, go to Alaska through the Bering Strait Tunnel, cross Canada, the United States, Mexico and Central America, to arrive at the Darién Train (with which the misnamed Darién Gap would be eliminated) between Colombia and Panama. From there, one could continue on two or three railroad branches (one along the Pacific coast, one along the Atlantic coast, and another down the central region of South America to cross Brazil), to reach the south of the continent in Patagonia, Argentina.

Any traveler, from any nation in the world, could arrive in Bogotá by this World Rail Land-Bridge (that is to say, the current Eurasian Land-Bridge with its extension to the American continent) and could travel within the city on a modern Metro, through which one could connect to every regional, national, and international railroad network. At least 8,000 km of wide-gauge rails in both directions and totally electrified, would traverse Colombia from North to South, and from East to West.

To prevent this great project of world integration from being carried out—at least with regard to Colombia, which is a key link in this global network of development and infrastruc-

ture corridors—the oligarchy has to date succeeded in halting the construction of modern railroads, which thus far has included the Metro for Bogotá, Cali, and Barranquilla. The Anglo-Dutch oligarchy has sponsored the political careers of the enemies of modern railroads, to keep Colombia as a feudal state. It was the international financial pirates, who intend to run the world from Wall Street and the City of London, who invented the so-called Transmilenio system, an elephantine and inefficient bus system, in place of the absolutely essential urban electric trains. The Transmilenio is the largest and most costly fraud to be imposed on Colombians on orders of the International Monetary Fund (IMF) and World Bank, agencies which represent the decaying international financial cartel which is today suffering through its worst crisis.

American statesman and economist Lyndon H. LaRouche, Jr. is the architect of the proposal to build a new, just international monetary and financial system, to replace the decrepit and usurious IMF. This New Bretton Woods, or new international financial architecture, will generate enormous volumes of long-term, low-interest credit to finance great infrastructure projects associated with the World Land-Bridge. It was precisely to discuss these questions and the ongoing collapse of the current international financial system, that the movement associated with LaRouche held a conference in Kiedrich, Germany Sept. 15-16, attended by 350 people from 40 nations, entitled, "The Eurasian Land-Bridge Is Becoming a Reality."

## Financing the Metro

There are many ways that building a Bogotá Metro could be financed. First, a Financial Reconstruction Corporation (or some great national infrastructure fund) must be established, authorized to issue bonds. This was the model used by [U.S. President Dwight] Eisenhower to finance the construction of the United States' great highway system. In addition to this concept of a Capital Budget, a portion of Colombia's foreign reserves could be channeled into that fund for financing infrastructure (and the Bogotá Metro, in particular). This is precisely the idea behind the Bank of the South: to create a financial instrument, part of whose reserves would be designated for financing great projects, rather than permitting our money to sit in foreign banks, which use the funds but don't lend them to us when we need them.

In the early years of the U.S. Republic, the first Treasury Secretary, Alexander Hamilton, issued money that was used as credit for financing the development of manufactures (industrialization), mechanization of agriculture, and promotion of great infrastructure works. The primary issuance of money

## Proposed World Land-Bridge

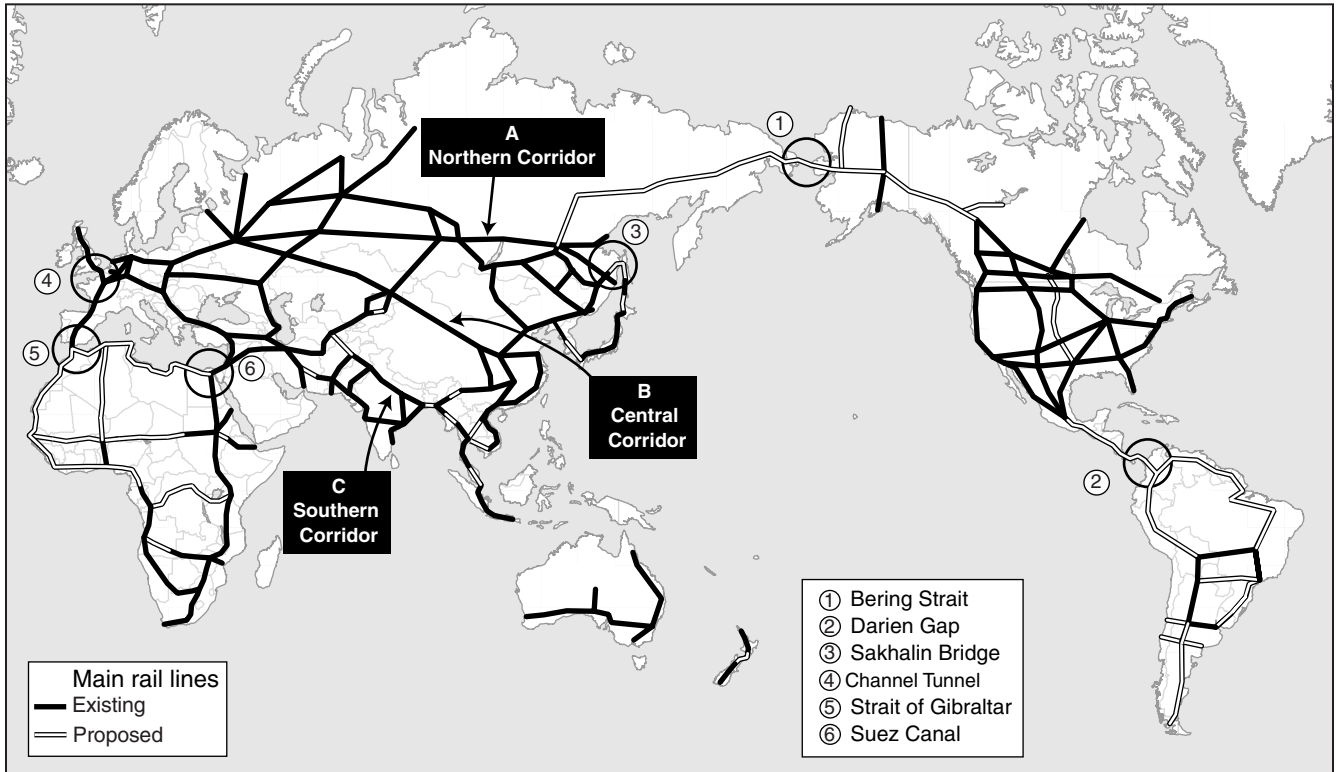

was backed by the production of machine tools and tangible goods, which counteracted any inflationary tendency.

LaRouche has warned that the U.S. housing crisis and collapse of the dollar are only a manifestation of the explosion of the financial bubble that has been building for the past nearly 40 years, since the United States abandoned the policy of encouraging industry and science that was promoted by President Franklin D. Roosevelt, a policy with which he pulled the United States out of the Great Depression, and saved humanity from the threat of the Nazi dictatorship.

The oligarchy is hysterical over the candidacy of Samuel Moreno Rojas for Mayor of Bogotá, among other reasons, because he is the grandson of Gen. Gustavo Rojas Pinilla (and because he has expressed his support for the proposal to build a modern transport system for the city, around a Metro). The oligarchs in our country, peons of the international financial speculators, get goosebumps when they think about the mere possibility that a person might escape the iron-fisted control of the usurers' cartel that has long run the country, and could win a key governing position in Colombia.

It was President Rojas Pinilla (1953-57) who built a large portion of what little there is of national infrastructure in Colombia, including the El Dorado airport and 18 others. From the very beginning, Rojas had reserved lands for the expansion of a second airport runway, but afterwards, President Alberto Lleras Camargo gave those lands away, and now it will

be necessary to buy them at astronomical prices. In the end, Rojas had paved nearly all of the major highways, and had built a large portion of the aqueducts, sewer systems, and highways across the nation.

Also, in 1956, Rojas created the Colombian Institute of Nuclear Affairs, through which we became pioneers in this field of scientific research. Rojas also contracted the services of David Lilienthal, who, during the Franklin Delano Roosevelt Administration in the U.S., ran the famous state-run Tennessee Valley Authority (TVA). Lilienthal proposed to Rojas that the Cauca and Sinu river basins could serve as the underpinnings of a Colombian TVA system. The TVA built electrical energy plants, dams, canals, aqueducts, hospitals, highways, universities, and more.

To take up the path of development, jobs and peace, vote in favor of the Darién Railroad and the Bogotá Metro. Organize your family, friends, and fellow citizens to give their support to these initiatives that will offer Colombia the possibility of becoming a genuine industrial and agricultural power, to create the jobs necessary so that we don't have to export our own citizens, as is happening now. More than 5 million people have had to leave the country because here, they can't even earn the miserable wages they can earn as slave labor in the U.S. and Europe.

Colombia should join the World Land-Bridge without delay, beginning with the construction of a Darién Train and a Metro for Bogotá.

# Make What Is Reasonable Possible: Darién Train and Bering Straits Tunnel

by Maximiliano Londoño

*Mr. Londoño is the president of the Lyndon LaRouche Association of Colombia*

On the occasion of the 85th birthday of U.S. economist and statesman Lyndon H. LaRouche, important world figures from the various fields of statesmanship, science, and the arts, wrote messages or participated directly in an international conference held in Kiedrich, Germany on Sept. 15-16, entitled "The Eurasian Landbridge Becomes a Reality." Dr. Héctor A. Múnera, prominent scientific researcher and former director of the Colombian Institute of Nuclear Affairs, sent a document to the event entitled "Two Great Engineering Projects for the Social and Economic Development of the Atrato Region of Colombia," in which he advocates the completion of the Pan-American Highway, a mere 100 kilometers, across the border zone between Colombia and Panama.

Múnera presented a synopsis of various proposals for building interoceanic canals that would connect the Atlantic to the Pacific, among which the most prominent is Route 25, that is, the Atrato-Truandó Canal. Múnera recalls that in the 1980s, the Inter-Oceanic Canal Study Commission carefully considered the use of nuclear explosions for building canals between the two oceans. In a later article, Múnera detailed the potential application of peaceful nuclear energy in the developing nations.

In the context of a dialogue among friends from various cultural and ideological currents, which LaRouche is promoting on an international level, I offer the following observations:

1. Highways do not replace railroads. On the contrary, the mode of rail transport is a support to both highway and water transport. As the physicist and mathematician Bernhard Riemann demonstrated, and as has been elaborated by physical economist LaRouche, the only true source of an increase in real productivity of a process, is to regularly incorporate new universal physical principles. And the most advanced railroad mode today is the magnetic levitation, or maglev, train. Germany and Japan are in the lead in developing viable maglev designs, although China is currently the only nation that has built an operational maglev track, using German technology.

It is ironic that two Americans, James Powell and Gordon Danby, obtained the first patent in 1966 in the field of superconducting magnetic levitation. Nonetheless, the United States has still not built a maglev system. It is a shame that the U.S., which was the pioneer with Lincoln's Transcontinental Railroad, currently has barely 10% of its train system electrified. U.S. backwardness is only comparable to that of Great

Britain, while the rest of Europe is moving toward the use of completely electric locomotives which can go from 300-350 kilometers per hour. The first-generation maglev trains can travel at 500 km/hour, although Powell and Danby, in particular, are working on a second generation, not just for passenger transport, but also for cargo containers. With magnetic levitation technology, it will be possible to put satellites in orbit or to launch space voyages at a fraction of the cost of missiles currently propelled by liquid or solid fuel. And so, in the Darién, a train should be built, preferably maglev, or perhaps a hybrid, that is, with electric tracks, but which could simultaneously operate with maglev trains. (See James Powell and Gordon Danby, "Maglev: Transport Mode for the 21st Century," *EIR*, Sept. 21, 2007).

2. Let us make what is reasonable, possible, and not adapt to absurd fashions and ideologies, like environmentalism, which in the specific case of the Pan-American Highway, has been the argument for holding onto the so-called Darién Gap; that is, on the pretext of not disturbing the flora and fauna of the region and respecting indigenous cultures there, construction of the final 100 kilometers of the highway has been blocked, thereby preventing travel by highway from Vancouver, Canada to Patagonia, Argentina. In other words, the routes both of the Pan-American Highway and the Darién Train should be chosen in accordance with what is most appropriate for the project, and not from the standpoint of propitiating the environmentalists, who in fact want neither project carried out. Of course, feasibility studies should be carried out to adequately resolve legitimate issues of the environmental and social impact that these infrastructure projects could have, but the projects should be implemented.

As LaRouche has insisted, if the United States provides competent leadership, the rest of the world will respond favorably. And one indication of this was seen when, in 1880, the pro-Lincoln Illinois Sen. David Davis proposed the first congressional bill for the study and ultimate construction of the Intercontinental Railroad. By 1889, the Intercontinental Railroad Commission was in operation, and groups of U.S. engineers, in association with their counterparts from other nations, began the relevant field studies. However, at the Fifth Inter-American Conference in 1923, there was a dramatic setback to this perspective, and the Pan-American Railroad was abandoned; it was decided instead to promote the Pan-American Highway. In May 1971, acting under the authority of a law previously approved by the U.S. Congress, separate

agreements were struck between the governments of the United States and Panama, and the United States and Colombia, according to which the U.S. committed to financing two-thirds of the total cost of the construction of the remaining span of the Pan-American Highway, in the Darién zone. Although that U.S. law remains in effect, in October 1975, the Federal District Court for the District of Columbia prohibited allocation of funds for the construction of the Pan-American Highway in the Darién, as part of the legal case brought by the Sierra Club and other ecologist groups which questioned the environmental impact studies that had endorsed the decision to begin construction of the Darién highway.

In 1996, after international bidding, Colombia's National Institute of Roads (INVIAS) contracted new environmental studies, this time with a consortium made up of Ecology and Environment, Inc. and Hidromecánicas Ltda. And despite the fact that the National Congress of Engineering of Colombia, held Aug. 14-16, 2004, determined that this project should be given priority, to this date there has been no construction on the Darién Highway, either on the Colombian side or the Panamanian side. It must be noted that President Alvaro Uribe has insisted, to no avail, that the successive Presidents of Panama, Mireya Moscoso and more recently Martín Torrijos, promote the construction of the final span of the highway. But, on the Panamanian side, there has been no political will to carry out the project. In truth, both in Colombia and in Panama, the ministries of the environment have vetoed the highway's construction.

In sum, as LaRouche and his associates have documented, environmentalist is fascism, created by the British Crown to return humanity to the Dark Ages. And this must be stated clearly.

## Engineering Projects For Development of Colombia's Atrato Region

by Héctor A. Múnera

*Dr. Múnera teaches at the Department of Physics, National University of Colombia, Bogotá, Colombia. He presented the paper excerpted here to a Festschrift honoring Lyndon LaRouche on his 85th birthday, Sept. 8, 2007. The full title is "Two Large Engineering Projects for the Social and Economic Development of the Atrato Region in Colombia."*

### Dedication

During the second half of the 20th Century, Lyndon LaRouche has been an outspoken advocate for the economic development of Third World countries, whose progress may be

hampered by extreme concerns about protection of the environment. As pointed out by him, extreme environmentalism may condemn some regions of the world, like my country, Colombia, to stay in their current state of lesser economic development, while the more advanced countries reap the benefits of development previously attained at a lower cost, when the environment was not given the paramount importance of nowadays. This is clearly inequitable.

Also of great interest to us is a related theme of LaRouche's: the transfer of technological knowledge. A tool towards this end may be the peaceful use of nuclear technology. The latter idea was already envisioned by another statesman, the former U.S. President Eisenhower, with his program of Atoms for Peace in the early 1960s. But the development of nuclear-powered electricity was almost completely stopped by the environmentalist movement in the United States in the mid-1970s. On a global scale, today we are close to a rebirth of nuclear power using inherently safe, modular, small nuclear plants that could also be used in developing countries. The LaRouchian movement has also advocated the massive use of nuclear power as a means to build infrastructure, as in the Eurasian Land-Bridge.

It is a privilege and a pleasure to join the *Festschrift* honoring the very original thinker Lyndon LaRouche on his 85th birthday. This short note is related to the completion of the Pan-American Highway, a project that is a natural complement to the Eurasian Land-Bridge. In a separate, forthcoming note we will advance some ideas for the revival of nuclear technology in Colombia.

### Introduction

By the mid-21st Century, will it be possible to go easily by land from the Cape of Finisterre in Portugal to Ushuaia in Argentina? Three key elements are missing today: the Eurasian land-bridge, the tunnel across the Bering Strait, and the Inter-American Land-Bridge. The first two aspects have received ample consideration within the LaRouchian movement, so that this note concentrates on the third element, from the broader context of social and economic development of the isolated Atrato River region in Colombia.

A forthcoming note will address the various roles of nuclear technology for peaceful use in a developing country: (i) a means for transfer of technological knowledge; (ii) a technological tool in medicine, agriculture, engineering, environment; and (iii) a builder of infrastructure for social and economic development, such as electricity, water, and process heat. For the time being, the present note mentions some past proposals for the use of nuclear explosives for the excavation of an inter-oceanic canal in the Atrato region.

The Atrato River is about 700 km long, flows from south to north through a dense rainforest, and has a large mean discharge of some 4000 m<sup>3</sup>/s into the Gulf of Urabá in the north-western corner of South America, close to the international boundary between Colombia and Panama. In some stretches,

the river serves as a border between the Colombian Departments of Chocó and Antioquia. The Atrato region, one of the rainiest on Earth, is covered by a jungle with an extremely high biological diversity. The population is sparse, mostly Afro-Colombian (over 90%), with some indigenous groups like the Noanamaes, Katíos-Emberas, and Kunas (the latter were forced to move to Panama by tribal fighting). Due to its strategic geographical position, three groups of large engineering projects have been considered for this region: a land-bridge to connect Central and South America; a waterway between the Atlantic and Pacific oceans; and large hydro-electrical power plants taking advantage of the permanent very high water discharges of both the Atrato and San Juan rivers. In some proposals, the hydropower projects could be part of an inter-oceanic canal project. Since the mid-1970s, these hydro projects have been incorporated into the inventory of potential electrical sources in Colombia, and no further mention of them will be made here.

### The 21st-Century Balboa Land-Route

In the year 1500, during Columbus's fourth trip, the Spaniard Rodrigo de Bastidas arrived at the Gulf of Urabá. San Sebastián de Urabá was the first Spanish settlement in South America, founded in 1509 on the eastern shore of the Gulf of Urabá by Alonso de Ojeda; it did not survive, due to pressure from local indigenous people. A year later, Santa María La Antigua del Darién was founded on the western side of the same Gulf, and it served as a base for the initial exploration of the adjacent territories, which today are part of Panama and Colombia. It is an irony of history that the region of the Atrato River, the first part of South America explored by Europeans 500 years ago, remains as one of the less developed areas in Colombia at the beginning of the 21st Century.

Vasco Nuñez de Balboa departed from Santa María with an expedition that crossed the Panama Isthmus and reached the Pacific Ocean in 1513. With the help of indigenous guides, Balboa went by boat to Carreto Bay, or thereabouts, navigated in a *piragua* (a dugout canoe) upstream on one of the many rivers discharging into the Caribbean, then crossed by foot the rather low Serranía del Darién, descended following the course of a river draining into the Chucunaque River, and navigated by *piragua* downstream on the Chucunaque until reaching the Gulf of San Miguel on the Pacific Ocean. . . .

The idea of a railroad running from Alaska to Patagonia goes back at least to the first Conference of American States in 1899. Some consideration was given to this proposal as witnessed by the map proposed in 1904 by Charles M. Pepper, United States and Pan-American Railway Commissioner.<sup>1</sup> Instead, in 1923, during the fifth Conference of American States, a decision was made to build a Pan-American Highway, which today is almost complete, except for the Darien Gap, which is about 90 km in a straight line between Yaviza in Panama and El 40 (also called Lomas Aisladas), near Chigorodó in Colombia. When, and if, the Darien Gap is closed, the 26,000 km

backbone of the Pan-American Highway will be complete.

The current project to close the Darién Gap is a road that divides in half the Darien National Park in Panama, which was declared a World Heritage Site in 1981 and a Biosphere Reserve in 1982. The Pan-American highway will parallel the Tuira River, up to Palo de Letras, where it will cross the Serranía del Darién, which in this zone is the border between Panama and Colombia. The road descends into the Katíos National Park in Colombia, which was inscribed on the list of World Heritage Sites in 1994.<sup>2</sup> The length of the project in Colombia is 41 km from Palo de Letras to Cacarica on the Atrato River (30 km), and then to El 40 (11 km). In the lowlands there are many swamps associated with the Atrato River.

Both in Panama and in Colombia, there are groups in favor and against the construction of the missing portion of the Pan-American highway. Proponents stress political integration and economic and commercial benefits, while opponents stress negative impacts—deforestation, perturbation of habitats—on the two national parks, which harbor a large genetic and biological wealth, and negative cultural effects on the indigenous inhabitants in the national parks, mainly Emberas. An additional negative aspect is the possible migration from south to north of undesirable guests, such as guerrilla groups, drug traffickers, and hoof-and-mouth disease, which still afflicts cattle in some Colombian regions.

As a compromise, there have been suggestions, such as in the Bio-Pacific study, for an alternative way to close the Darien Gap, without crossing the two national parks. It is based on a new road to the Bay of Carreto on the Caribbean coast of Panama, followed by a ferry connection to Turbo on the east coast of the Gulf of Urabá. As expected for a ferry connection, this alternative will limit and slow down the road traffic along the Pan-American Highway.

In the opinion of the present writer, the concerns of the environmental groups for the protection of the two National Parks are legitimate, but it is also clear that a ferry connection is not the most efficient way to complete the Pan-American Highway. Instead of the ferry connection, it is possible to build a land-bridge without entering the Darien and the Katíos National Parks. This novel alternative is called here the Balboa Route-2007.

The Balboa Route-2007 may branch from the existing Pan-American Highway, say at the little town of Palmira in Panama, and go northwest across the Panamanian central plain to reach the Caribbean coast. In this stretch, the road bridges the Chucunaque River near the mouth of Mortí River, follows the Mortí River canyon upstream until a summit pass on the Serranía del Darién, and descends to the coastal plain (alternatively, the Serranía may be crossed by tunnel). On the Caribbean side, the road is in Kuna-Yala Province, and runs southeast, parallel to the Caribbean coast. After passing Carreto Bay, the road reaches the Panama-Colombia border in the vicinity of Tiburón Cape, which is the only zone of the international border outside the Darien National Park. The road will turn south in Colombia

FIGURE 1  
**EIR's Proposed Route for the Atrato-Truandó Canal (1996)**

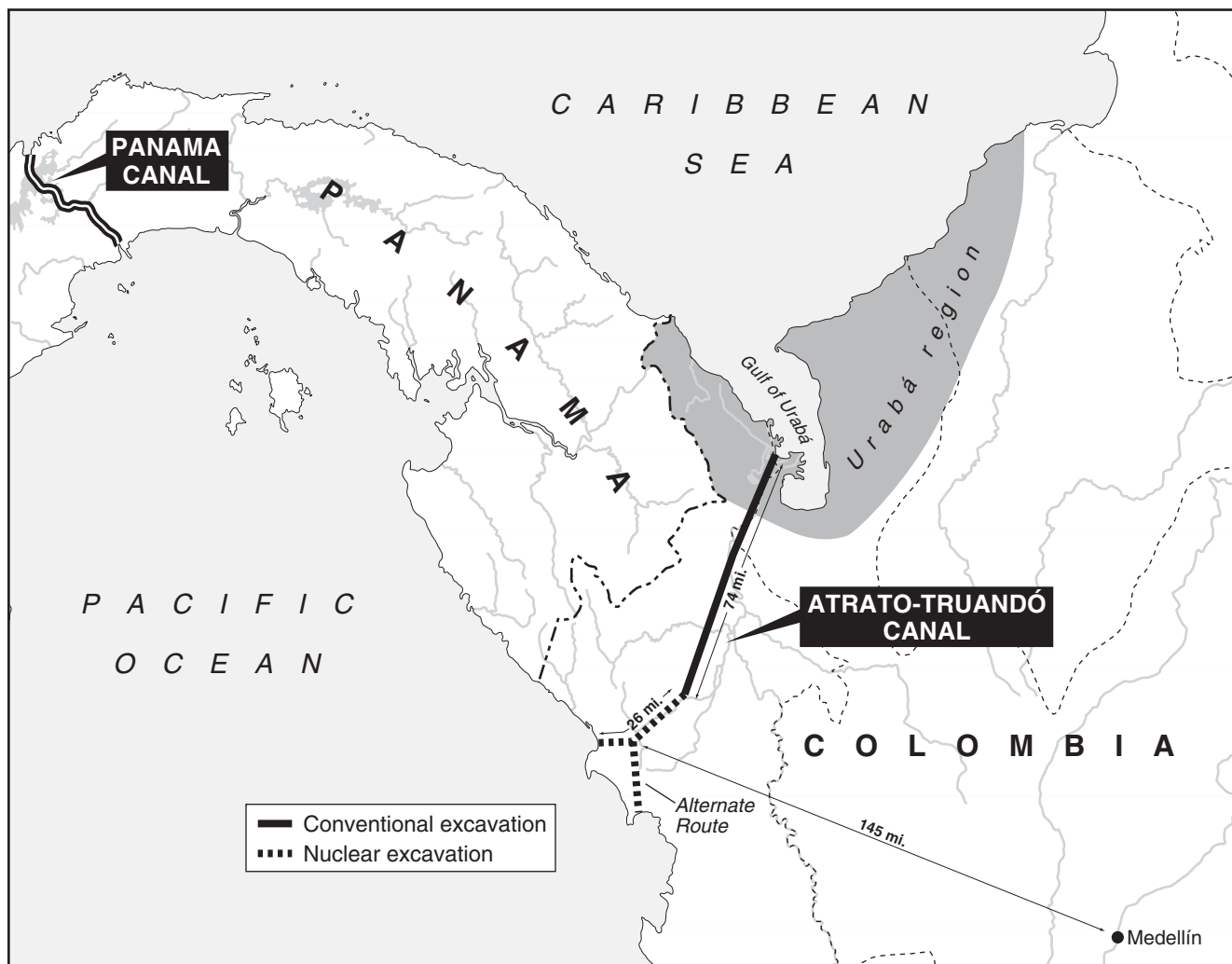

along the western shore of the Gulf of Urabá, until reaching the Atrato swamps at Unguía. The proposed route turns east, bridges the Atrato River, and joins an existing road leading to Carepa in the vicinity of Caño Carepita.

The Balboa Route-2007 is longer than the current proposal to close the Darien Gap, but it has two significant advantages: It is outside ecologically preserved areas, both in Panama and Colombia; and it brings needed infrastructure to regions currently undergoing economic development. In Panama, the road may open to tourism this section of the Caribbean coast, which today is mostly populated by the Kunas, so that there will be a need to negotiate with the government of Kuna-Yala Province. In Colombia, the proposed route will serve the towns of Zapzurro and Capurganá, which presently are open to ecological tourism, but cannot be reached by land. There exist already stretches of dirt roads between Acandí and Triganá, and between Tanela and Unguía in the Department of

Chocó, and from Caño Carepita to Carepa in a banana-producing region of the Department of Antioquia. The proposed route will complete and improve these roads.

The proposed Balboa Route-2007 will finally complete a project envisioned more than a century ago. An operating Pan-American Highway from Alaska to Patagonia would be the natural companion to a Eurasian Land-Bridge.

### **The Atlantic-Pacific Interconnection via the Atrato River**

In the 1880s, Colombia entered into a contract with France for the construction of a sea-level canal across Panama, which at that time was a Department of Colombia. Ferdinand de Lesseps, who already had built the Suez Canal, was in charge of the project. Unfortunately, malaria and yellow fever led to failure. After Panama separated from Colombia, the present canal with locks was built by the United States, between 1904

FIGURE 2  
**Five Routes for Inter-Oceanic Canals**

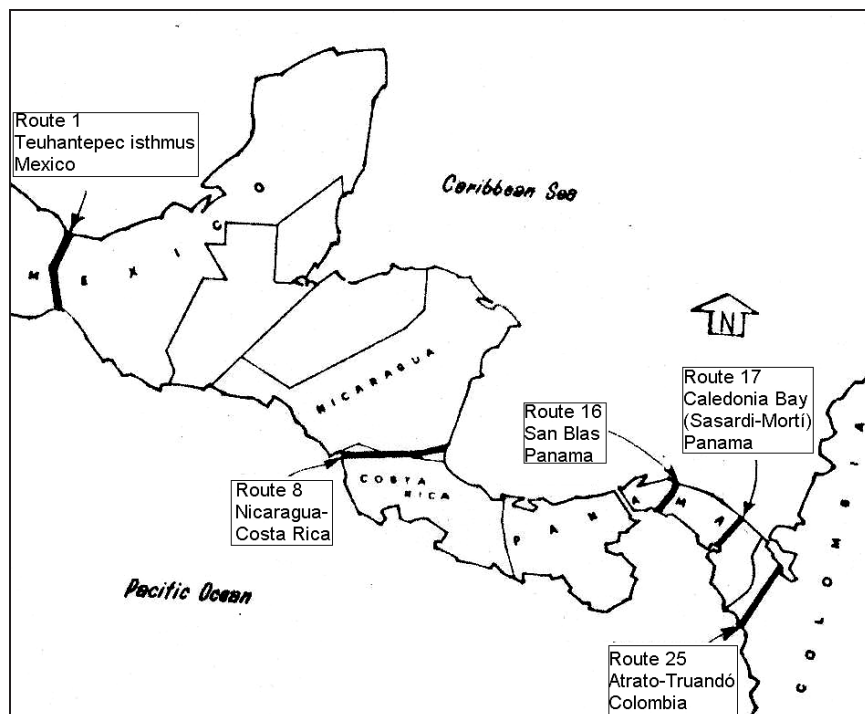

*These routes are geologically viable for excavation with nuclear explosives.*  
 Source: E. Graves, "A New Canal," Nuclear News (February 1965).

and 1914. The width of the Panama Canal cannot accommodate today's large oil tankers and other modern vessels; additionally the canal is overcrowded. As a partial solution, Panama on Sept. 3, 2007 started construction of a US\$5,000 million expansion of the canal, which will be ready in 2014. This expansion will allow larger ships to cross, but will not solve the problem of overcrowding.

The possibility of building a canal across Nicaragua has been known since the mid-16th Century; different routes, some with locks, other at sea-level, have been considered. Today, at the beginning of the 21st Century, there is still interest, as an alternative for solving the overcrowding in Panama. Routes using the Atrato River are another alternative, as discussed next [see **Figure 1**].

There is a long tradition from the Spanish chronicles that were collected by Baron Alexander von Humboldt in the early 1800s, hinting at the existence in the Atrato River region of a route to pass from the Pacific Ocean to the Caribbean Sea. The Raspadura, a short, small canal of some 8 km in length, has apparently existed at least since 1788, joining the small Quito River, tributary of the Atrato, to another small river flowing into the Pacific Ocean. As an anecdote, it is mentioned in passing that there are suggestions that Chinese explorers could have used this route in pre-Columbian times.<sup>3</sup> Recent DNA studies have evidenced a high affinity between Chinese and

Japanese people and some indigenous groups settled in the Atrato region since pre-Columbian times. This evidence lends some credibility to these folk traditions.

After Humboldt's writings, for 50 years there was no serious consideration of the possibility of building a canal to communicate between the Atlantic and Pacific oceans using the Atrato River. In 1852, Mr. F. Kelley of New York funded an expedition to survey the Atrato River from its mouths in the Gulf of Urabá to the mouth of Quito River, near Quibdó,<sup>4</sup> the current capital of the Department of Chocó. The Atrato River is wide, and may be easily navigated as far as Quibdó, which is at an altitude of 40 meters above sea level, and about 400 km upstream from the Gulf of Urabá, which means that the river has a very small slope of 1 meter in 10 km.

By the mid-20th Century, as part of the U.S. Plowshare project, the possibility of using nuclear explosives to build a waterway between the Atlantic and Pacific oceans was analyzed in considerable detail by the Atlantic Pacific Inter-Oceanic Canal Study Commission.<sup>5</sup> **Figure 2**

shows five routes that were identified by the former U.S. Atomic Energy Commission (USAEC) as being suitable for the use of nuclear explosives.<sup>6,7</sup> From the point of view of isolation and sparse population, routes 17 and 25 in Panama and Colombia, respectively, were identified as the most promising routes for using nuclear explosives. The Sasardi-Mortí River Route 16 is relevant in the context of the present writing, because it is part of the Balboa Route-2007 proposed in the previous section. The fact that nuclear explosives are viable, means that the geology in the area of the Mortí River may be appropriate to build a tunnel to cross the Serranía del Darien.

The study released in 1970 by the Atlantic Pacific Inter-Oceanic Canal Study Commission,<sup>5</sup> also considered Route 23N as potentially suitable for nuclear excavation. The route connects the Gulfs of San Miguel in Panama and Urabá in Colombia, involving the Tuira River in Panama and the Atrato River in Colombia. The study also included an all-conventional Route 23C, and a combined route using conventional and nuclear explosives. In the early 1980s, some attention was given, both in Colombia and Panama, to the possibility of building such a project as a joint endeavor involving both countries. Interest eventually faded away. Since the general route is similar to the current project to close the Darien Gap with the Pan-American Highway, this project would be unacceptable today, on the same grounds as the projected road to



close the Darien Gap (recall previous section), even if built using conventional explosives only.... An exclusion zone would be required if the whole canal were excavated using nuclear explosives only (Route 23C). In an exclusion zone, all population would have to be evacuated for several years, a condition that may not be politically acceptable today.

In addition to the proposals including nuclear excavation, since the beginning of the 20th Century, several alternatives for an all-Colombian sea-level canal have been advanced, using various rivers discharging into the Atrato River from the west.... In all cases, the water divide is low and close to the coast of the Pacific Ocean, so that construction of a canal by conventional means is quite possible. There are several potential sites for deep harbors, such as Cupica Bay. This subject is still alive in several engineering quarters.<sup>8</sup>

Given the growing demand for use of the Panama Canal, it seems that a reconsideration of a sea-level canal in the Atrato region may not be out of the question. Anticipating criticisms, it may be worthwhile to recall one of LaRouche's themes: to be valid as a decision-making tool, cost-benefit analysis must necessarily include long-term social benefits. This issue was clearly summarized in a past editorial of the *21st Century* journal:<sup>9</sup> "Essential infrastructure—whether nuclear energy, or national rail systems—should not be measured with an annual cost-benefit yardstick that ignores both the future—and the past."

## References

1. C.M. Pepper, "The Pan-American Railway," *Bulletin of the American Geographical Society*, Vol. 36, No. 8 (1904), pp. 466-470.
2. [www.unep-wcmc.org/](http://www.unep-wcmc.org/)
3. G. Menzies, *1421 The Year China Discovered the World* (London: Bantam Press, 2006).
4. F.M. Kelley, "Explorations Through the Valley of the Atrato to the Pacific, in Search of a Route for a Ship Canal," *Journal of the Royal Geographical Society of London*, Vol. 26 (1856), pp. 174-182.
5. U.S. Army Corps of Engineers, *Inter-Oceanic Canal Studies-1970, Annex V—Study of Engineering Feasibility* (Washington, D.C.: Atlantic Pacific Interoceanic Canal Study Commission, Dec. 1, 1970). Appendix 14, Route 23.
6. E. Graves, "A New Canal," *Nuclear News*, February 1965, pp. 13-17.
7. E. Graves, "Nuclear Excavation of a Sea-Level Isthmian Canal," *Proceedings of the Conference on Engineering with Explosives* (Washington, D.C.: USAEC, 1964), pp. 321-334.
8. J.-E. Botaggisio, "Alternatives for an Inter-Oceanic Canal in Chocó" (in Spanish), talk to the Engineering Society of Antioquia (Sociedad Antioqueña de Ingenieros), Feb. 20, 2007.
9. M.M. Hecht, "How To Build 6,000 Nuclear Plants," *21st Century Science & Technology*, Spring 2005, pp. 2-3.

# Danish Campaign for Maglev Picks Up Speed

by Michelle Rasmussen

The Schiller Institute in Denmark has escalated its campaign for Denmark to be the first nation in Europe to build a magnetic levitation (maglev) network, with a three-pronged intervention into the current optimistic infrastructure debate. The momentum toward a new domestic bridge project now seems to be unstoppable, after the completion of the internal Great Belt bridge and the Öresund bridge to Sweden, and the agreement to build a Fehmarn Belt connection to Germany (see map). The only question is, will it be with or without a maglev track.

That must be the conclusion after a conference on "A Connected Denmark: Vision for Establishing a Fixed Kattegat Connection," in Copenhagen on Oct. 3, sponsored by regional politicians from Denmark's Jutland mainland and the city of Copenhagen. The meeting was called to discuss building a new connection across the Kattegat Sea between Denmark's two largest cities, Copenhagen and Århus, which the Schiller Institute has also promoted during the past year. The Institute's proposal to make the new connection the first phase of a national maglev system, was discussed at the conference from the floor by Institute representatives, and from the podium by one of the speakers. Press coverage of the conference in Denmark's largest newspaper, and the website of the Danish Engineers, led with the maglev proposal (although claiming that it lacks support).

The Schiller Institute also brought "maglev trains" to the Danish Parliament, during the yearly open house on Oct. 12, visiting the various parties' hospitality suites wearing "maglev hats." Several MPs enthusiastically reported on their having ridden on the maglev in Shanghai, the only commercially operating maglev in the world.

Institute activists spoke with 17 parliamentarians from five parties, including three party leaders, and with two government ministers, including the new transportation minister. The organizers counterposed the optimism of their maglev plans and Lyndon LaRouche's solutions, with the graveness of the ongoing international financial collapse. The Institute will testify before the Parliament's Political and Economic Committee on Oct. 25.

In addition, Tom Gillesberg, the chairman of the Schiller Institute in Denmark, and three Institute activists have announced independent campaigns for Parliament, under the slogan, "After the financial crash: Maglev across the Kattegat." Tom Gillesberg will run in Copenhagen, Feride Istogu Gillesberg in the Copenhagen suburbs, Janus Kramer Møller



in Århus, and Hans Schultz in Aalborg. There is enthusiasm at the prospect of going maglev especially in Århus and Aalborg, which promises to create great interest in the election campaigns there.

### The Kattegat Conference

The conference, held in the Danish Engineers' building, was attended by 180 participants, including members of the Parliament's Traffic Committee, mayors, engineering companies, business representatives, and interested citizens. It was opened by the Mayor of Århus, Nicolai Wammen (Social Democrat), who stated that a new Kattegat bridge could be ready by 2020, and called for the government to begin the initial studies for the project as soon as possible.

Traffic economist Uffe Jacobsen, who has been instrumental in arguing for a new Kattegat connection, referred to a 1972 study which figured that such a project would have already been completed by 1990, and that it would count for around 50% of the traffic between the Jutland mainland and the island upon which Copenhagen is located.

In the discussion period, after a presentation by Alex Landex from Denmark's Technical University about including a high-speed, non-maglev, rail line across the Kattegat bridge, which would result in a one-hour travel time between Copenhagen and Århus, Schiller Institute chairman Tom Gillesberg brought up the advantages of maglev, and asked the speaker if

he had considered this technology. The speaker responded that he had, but since it was important for the railroad lines to continue on to other Danish cities, a maglev line would be impractical. (The Institute has proposed a national network to solve that problem.)

Speaker Poul Arne Jensen, a representative of Danish industry from one of the Jutland regions, excitedly spoke about his trip on the Shanghai maglev, and added: "As we heard here, the further vision is that if we had maglev, we could do it in 25 minutes. That is a fantastic vision, to think that that is possible."

Gillesberg added that the most important investment a nation can make is in infrastructure for the future, suggesting maglev again. The participants at the conference agreed to form a committee to continue the work on the project to unite the entire country.

The online edition of *Jyllands-Posten*, Denmark's largest newspaper, headlined its conference coverage, "Århus-Copenhagen in 25 Minutes." The article begins, "A trip on a maglev from Aarhus to Copenhagen could be made in 25 minutes. That was one of the more curious suggestions at the conference, which no politician spoke warmly about." But if the enthusiastic response of Danish MPs to the Schiller Institute's intervention at the Parliament was any indication, the debate on maglev here is far from over.

For more on the Kattegat conference and the Schiller Institute's maglev campaign, see [www.magnetto.dk](http://www.magnetto.dk).



Schiller Institute organizers, with "maglev" hats, sing their maglev canons at the Danish Parliament on Oct. 12.



Courtesy of Stephen Dean

"I hope to see the beginnings of the application of fusion before I pass from the planet," says Dr. Dean.

## The Promise of Fusion Power

Dr. Dean, president of Fusion Power Associates, of Gaithersburg, Md., prepared this video address for the Schiller Institute's conference on "The Eurasian Land-Bridge Becomes a Reality," in Kiedrich, Germany, on Sept. 15-16. The last four issues of EIR have included other presentations from the conference. This video was recorded on Sept. 11, 2007. Subheads have been added.

Thank you for inviting me to speak at your conference today. I give you my apologies that I was not able to come in person, but I very much appreciate the opportunity to meet with such a distinguished group of people.

I'm going to speak today about the promise of fusion energy. Fusion is a process which is not yet quite commercially available. I've spent my entire career working on this problem, and I hope to see the beginnings of the applications of fusion before I pass from the planet.

Your conference today deals with a number of topics which are going to require new energy sources, or at least extensive

use of the energy resources that are available, and so I'd like to say a few words about why we need new energy sources. There is a lot of energy available in the world today, but there is going to be a growing demand in the world for more and more energy, as we go into the next 50 to 100 years.

Most of our energy today comes from the burning of fossil fuels, like coal and oil and natural gas. Many places in the world still get a lot of their energy simply from burning wood. But as the population grows, and as more and more projects are required for infrastructure and raising the standard of living of people on the planet, there's going to be a growing demand for the resources from which we get our energy.

Now one of the problems that we have in the world today is the uneven geographical distribution of these resources. Wars are being fought, even today, in the Middle East, over the question of who controls the supply of oil. In the burning of fossil fuels, there are many people that have environmental concerns, about the fact that the burning of fossil fuels puts CO<sub>2</sub> and other noxious materials into the environment, and there's a growing concern about the potential for global warming.

There are advanced technologies available, but in many cases these technologies, which do not have some of the disadvantages of fossil fuels, are not always economic, compared to their competition, and in many countries they are not sufficiently technologically advanced to deploy such technologies.

FIGURE 1  
Fusion Reaction

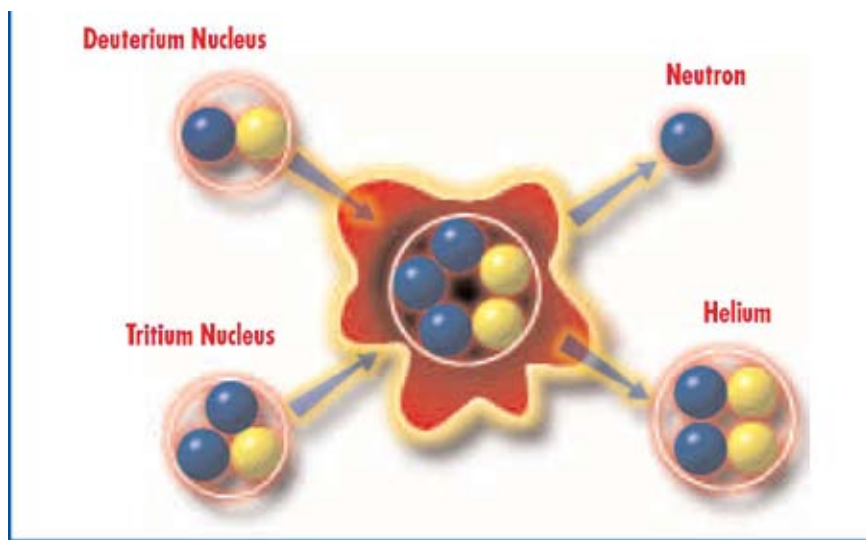

DOE

Deuterium and tritium fuse at high energy (10 KeV), producing helium and an energetic (14 MeV) neutron. Mass is converted to energy according to Einstein's formula  $E=mc^2$ . Fusion fuel releases almost 10 million times more energy per pound than fossil fuels.

FIGURE 2  
Principle of a Fusion Power Plant

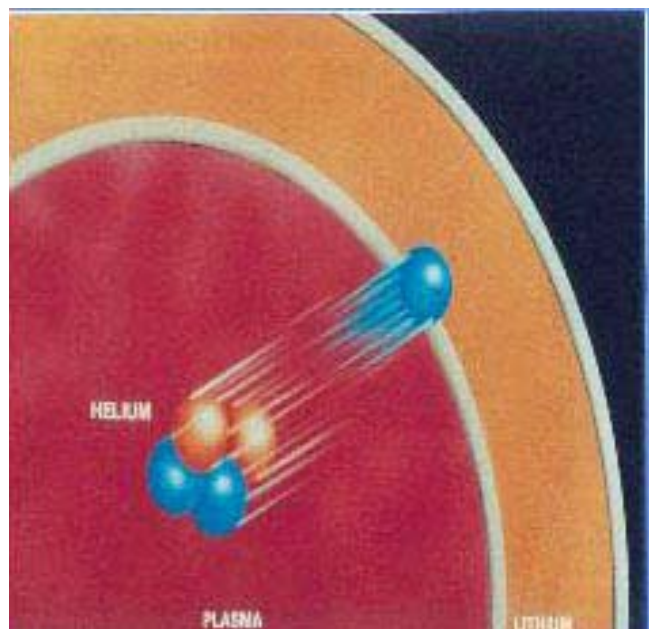

The helium nucleus gives up its energy to the plasma, thus sustaining its temperature. The energetic neutron is captured in a moderator blanket, heating it and reacting with lithium to produce tritium fuel.

Fusion Power Associates

### What Is Fusion Power?

But today I want to talk about fusion as one of these advanced technologies. Fusion is a nuclear process. We do, of course, have nuclear power today, based on the fissioning of uranium, that is, the splitting of uranium into parts. Fusion is the process that generates light and heat in the Sun, and in the other stars, and, as such, it is the dominant energy source in the universe. It is a nuclear process, but it is the combining of atoms, rather than the splitting of atoms, which is fusion,

It's most easily achieved on Earth by combining the heavy isotopes of hydrogen, deuterium, and tritium. Hydrogen is the lightest of all the elements. Deuterium is heavy hydrogen. Tritium is three times heavy hydrogen. These isotopes of hydrogen, when combined, form helium, which is the next heaviest element in the Periodic Table.

Deuterium, the heavy isotope of hydrogen, is found one part in 6,000 in ordinary water, and hence it's universally available, and eliminates the problem of the unequal geographical distribution of fuel resources. There will be fuel for fusion as long as there's water on the planet, which means that there will be fusion fuel available to all nations, as long as there's life on the planet.

Let's look at the fusion reaction itself (Figure 1). You see deuterium and tritium, the two heavy isotopes of hydrogen, schematically fused, and when they do, they disassemble

FIGURE 3  
Fusion Power Plant Schematic

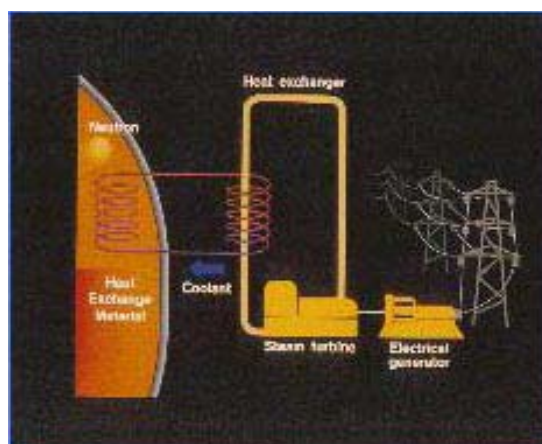

Fusion Power Associates

A conventional heat-exchange system removes heat from the moderator blanket. Heat is converted by a conventional power-conversion system.

themselves into the helium product, and a fast neutron. Mass is converted from the mass of two heavy isotopes of hydrogen, into the products, and in the process, mass disappears and comes out as kinetic energy of the products, according to Einstein's formula  $E=mc^2$ .

As I said, fusion is a nuclear process, and as such, it gives out much more energy per pound than the burning of fossil fuels. Fusion fuel, for example, releases about 10 million times more energy per pound than the burning of fossil fuels, and about ten times more per pound than the fissioning of uranium.

Why fusion? I mentioned that fusion fuel comes from water, and hence is abundant, widely available, and easily extracted from the water at low cost. The fusion reaction itself is environmentally friendly. It produces no CO<sub>2</sub> emissions, no radioactive waste from the fusion reaction itself, although the fast neutron does activate the structure of the fusion reaction; but those products have relatively low hazard potential, and relatively short half-life, and therefore do not require deep geological storage for many, many thousands of years.

### Multiple Uses

The primary goal of the fusion program worldwide has been, and is, the production of electricity in a central station power plant. However, that is not the only possible use for fusion. In competition with other energy sources, fusion may also be useful for the production of hydrogen, for the desalination of water, for the production of fuel for fission reactors, and for the deactivation of fission reactor waste.

Figure 2 shows a schematic of a fusion power plant. Fusion is a high-temperature process, as you can imagine, from knowing that it's the primary process in the Sun. In the core of

a fusion reaction is a very hot gas, ionized—it's called a plasma. And when the fusion reaction occurs in this plasma, the helium nucleus, which is the product, stays in the plasma and gives its energy to sustain the process, in a self-sustaining way.

The neutron, being uncharged, quickly leaves the central part of the reactor, and it is captured in a blanket where it heats the blanket, thereby creating the heat that's required for the production of electricity. It also, if there's lithium in the blanket, which we assume there will be, is used to produce the tritium, which is then fed back into the plant as fuel, because a neutron reacting with lithium produces tritium.

**Figure 3**, which further elaborates on the schematic of a fusion power plant, shows a conventional heat system which picks up the heat from the blanket, which then goes through a turbine, and in a conventional way, produces electricity in a conventional power system.

There are other schemes which people have thought of, such as the direct conversion of fusion reaction products to electricity, but this is the primary, simplest way to think about the operation of a fusion power plant.

To get a little more technical on you, I show on the next slide some of the technical approaches to fusion. The fuel, as I mentioned, has to be heated, up to temperatures such as exist on the Sun. We've done this many times for many years. It actually turns out to be very simple to do, even though you might think it's not. That hot plasma has to be confined long enough to get net energy, and a useful amount of energy, and there are two main technical approaches to do this: One is called magnetic confinement, in which magnetic fields from superconducting magnets are used to confine the hot plasma, away from the material wall. The other is called inertial confinement, where, for a very brief second, a lot of energy is produced before the plasma disassembles.

In magnetic confinement, the plasma itself is at subatmospheric densities, very low densities. In inertial confinement, the plasma is at very high density.

As I mentioned, the plasma must be confined at whatever density it's at, whatever temperature it's at, for a sufficient length of time to get a useful amount of energy out, and this product, the density times the temperature times confinement time, is called the Lawson criterion, and it's a figure of merit for progress.

Progress over the years is shown on

**FIGURE 4**  
**Fusion Progress and Projections**

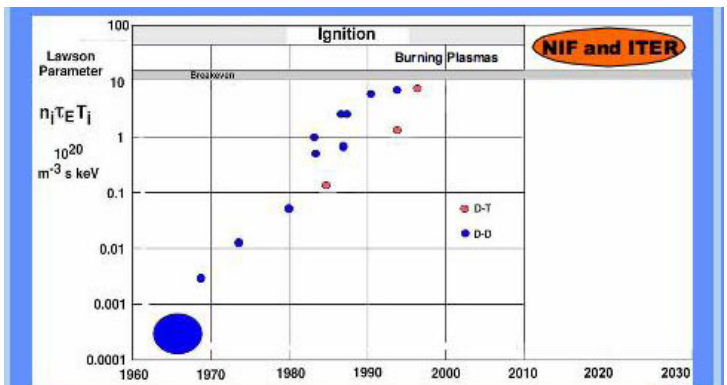

the next slide (**Figure 4**). Going back to 1960, you can see that the product of the density, the confinement time, and the temperature, was quite low. Over the years, in experiments around the world, that product has gradually gotten higher and higher and higher. Today we are very close to the regime we need to be in, called the burning plasma regime, and there are two fa-

**FIGURE 5**  
**The International Thermonuclear Experimental Reactor (ITER)**

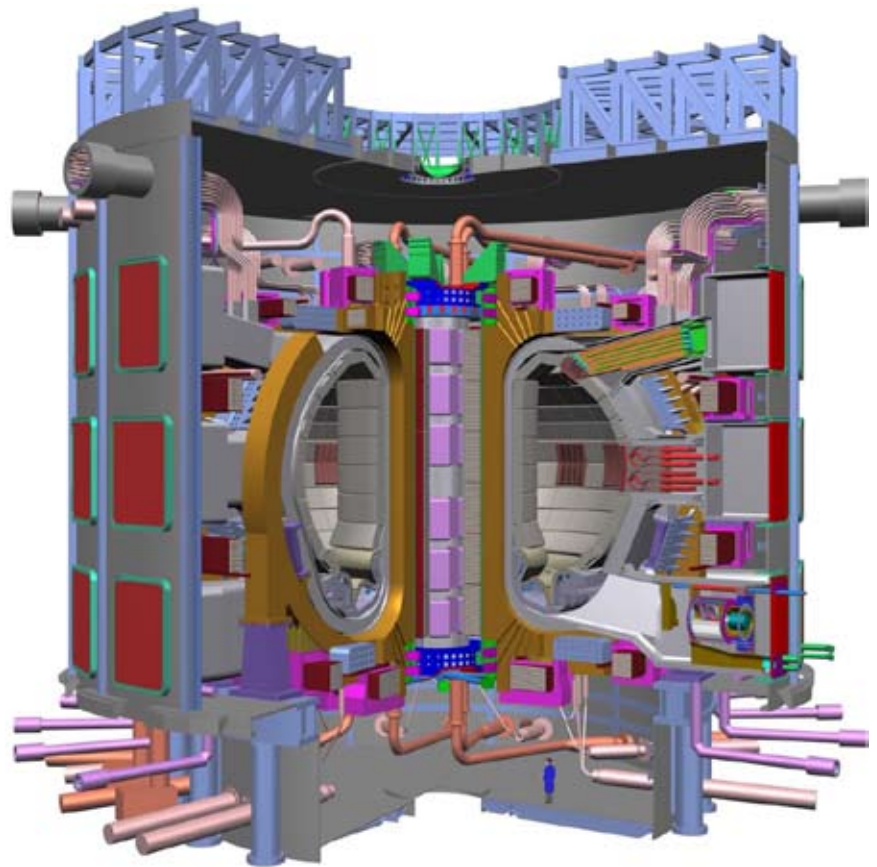

ITER

FIGURE 6

## National Ignition Facility (NIF)



Fusion Power Associates

*The laser-based NIF, under construction and in partial operation at Lawrence Livermore National Laboratory, is aimed at beginning ignition experiments in 2010.*

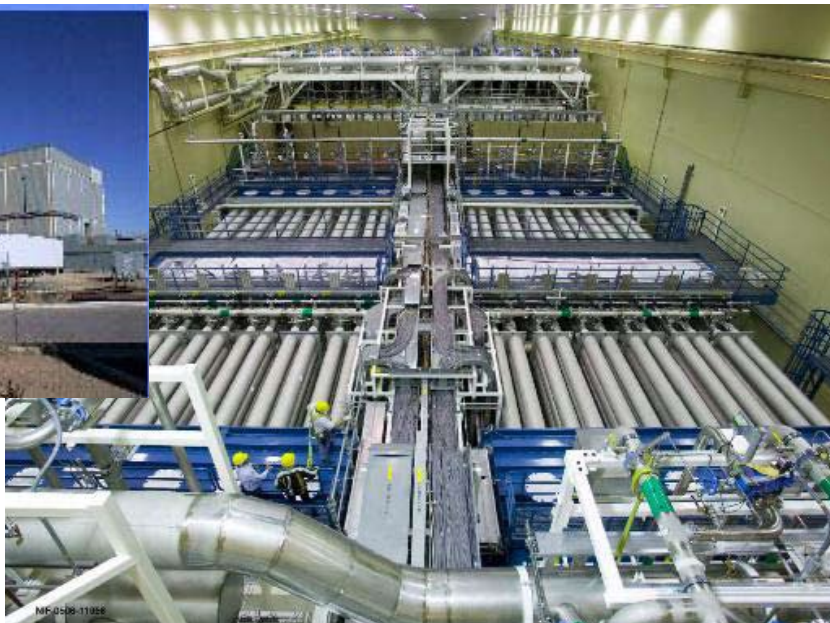

ilities, three actually, that are under construction now, that will produce net amounts of fusion energy for the first time. One is called the National Ignition Facility (NIF), the laser-based inertial confinement facility, which is being built in California. And a similar facility called LNJ is being built in France. And the other is called ITER, the International Thermonuclear Experimental Reactor, which is also being built in Cadarache, in France. And those two facilities will operate with net fusion power, sometime over the next one to two decades.

### The ITER and NIF Projects

Looking at ITER, I note that it's a joint venture of the Europeans, Japan, Russia, the United States, China, India, and Korea—seven parties banding together, working together, to be sited in France. Construction will be initiated shortly after the beginning of 2008. The agreements have all been signed; the details have been worked out. The people are starting to assemble as a team in Cadarache. The projected operational date for ITER is 2016. The important point to note is, there's going to be about 500-700 megawatts of thermal fusion power produced in this reactor, initially, for about 300 seconds at a time, but the facility itself is upgradable to produce this power in steady state.

**Figure 5** is a schematic of the ITER. The only thing that you really need to know is, if you look down very close to the bottom, you might see a shadow of a person, to give you an idea of the scale. The schematic shows the superconducting magnets that are used in the facilities, and the plasma goes in the very center.

In this area of magnetic confinement, the U.S. is about one-sixth of the world effort. The Europeans are about 45% of

the world effort, Japan is 25%, and others are 13%. If we look at the dollars that amounts to, the world effort is about \$1.5 billion, per year, of which the U.S. spends \$260 million.

**Figure 6** shows a photograph of the building in which the NIF, the inertial confinement facility, is being built at the Lawrence Livermore Laboratory in California. The facility is in partial operation now, but it's aimed at beginning its ignition experiments in just a few years, in 2010.

Below is a photograph of the interior of the building, showing some of the laser beams. This facility has 192 laser beams. They'll all be focused down on a very small pellet, containing deuterium and tritium, fusion fuel, and about once or twice a day, it will ignite these pellets and produce net fusion energy.

**Figure 7** comments that NIF itself is a precursor to an inertial fusion energy plan. The NIF facility, and also the LNJ facility of France, are single-shot facilities. They do this once, they're shut down for a few hours, new experiments are set up, and then they'll do it again. For an inertial fusion power plant, as shown in the corner, you must do this on a repetitive basis. For example, you must do it at like 10 Hertz, which is like 10 times a second, with an electrical efficiency of about 10%, from the wall plug to the energy that irradiates the fusion pellet. Right now, the lasers that we have are much lower efficiency, and only operate at one pulse at a time, but development is under way at a variety of facilities to up this repetition rate to the required frequency.

### Commercial Fusion

Beyond the NIF and ITER, one has to look at going from those facilities which are experimental, to a fusion power

FIGURE 7

### Is NIF a Precursor to an Inertial Fusion Energy Plant?

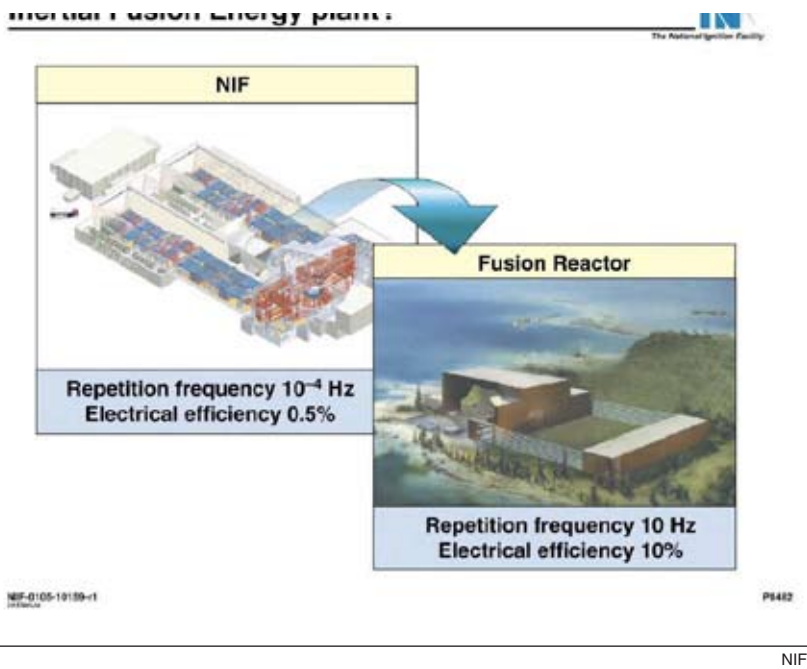

plant. One of the problems that fusion has had over the years, is that the governments of the world, even though they support the development to varying degrees, have not had a serious commitment to a schedule for bringing the development to fruition, and operating a fusion power plant. Back in 1976, I was involved in preparing a long-range plan, which aimed at producing fusion power in a demonstration power plant by the year 2000. The year 2000 has come and gone. All I can say is that the governments have not built the facilities, or provided the funding required, to meet that schedule.

Today, there are still large uncertainties as to when we will actually have a fusion power plant on the grid, based on not only technical unknowns, which still require significant R&D—research and development—but also due to lack of firm funding commitments, and to a lack of a firm schedule on the part of world governments. The projections that are made by the advocates of the various proposals of how we can get from here to the end, range from 15 years on the optimistic side, to maybe 50 years on the conservative side, with a mean of around 30 to 35 years.

As I mentioned, the governments have no firm commitment to any particu-

lar schedule, but the advocates do have a schedule, and I show you on my final slide, the European Magnetic Fusion Roadmap (Figure 8). It shows the ITER project, which I mentioned, and then it shows the other R&D, down at the bottom, that's required. And then in the middle, it shows the construction of a demonstration power plant. The schedule shown is in terms of the number of years after start of ITER construction, which, as I mentioned, would start early in 2008. And it shows the operation of a large-scale demonstration power plant about 30 years from now.

I hope that that meets with your own time scale. I know that many of the projects that you're talking about at this conference are aimed at 50 to 100 years kind of payoff. You're looking at the long term for the benefit of the people on this planet. And I think that fusion will come along in plenty of time to meet some of the demands, and in the meantime, we have a lot of other energy sources, like nuclear

power, which hopefully will fill the gap until fusion can come in, and add its contribution to the energy mix. I think, in the long run, we're going to need lots of energy sources, for a lot of different applications, and each one will have its niche, and hopefully, fusion will play an important role in the long term. Thank you for your attention.

FIGURE 8  
European Magnetic Fusion Roadmap

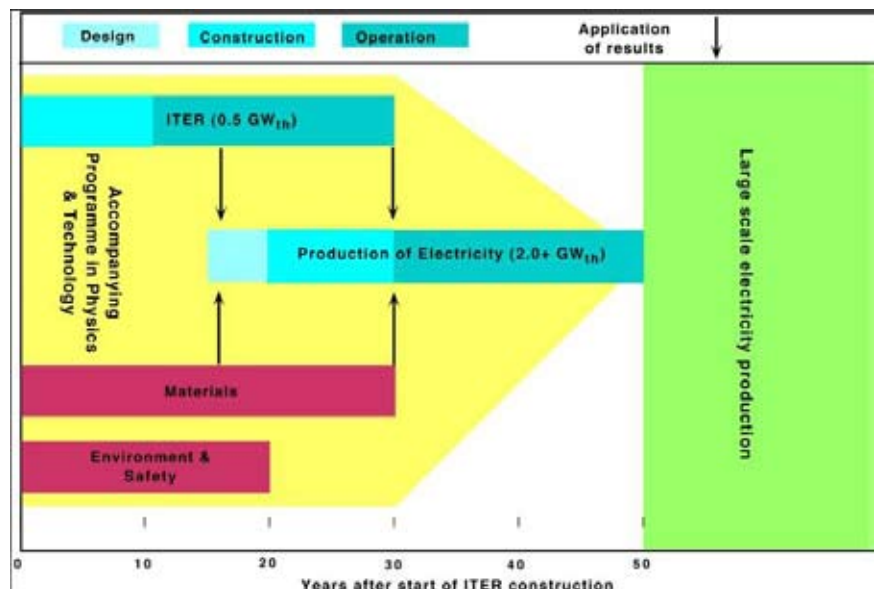

# PBMR: Clean, Safe, And Affordable Energy

*Tom Ferreira is Senior Manager of Corporate Communications for Pebble Bed Modular Reactor (Pty) Ltd. of the Republic of South Africa. This paper was prepared for the Schiller Institute's conference in Kiedrich, Germany, Sept. 15-16, 2007.*

Safe, clean, cost-competitive, versatile, and adaptable. These, in a nutshell, are the features of the Pebble Bed Modular Reactor (PBMR).

Locally, the PBMR technology has the potential to provide South Africa with competitive power generation in coastal areas. Internationally, it will be competitive with virtually all other forms of energy generation.

Most of South Africa's coal-fired electricity is generated by large-scale plants built near the pit-heads of two extensive coal-producing areas, both of them far inland on the eastern side of the country. This requires long power lines from the coal-rich areas to load centers away from the pit-heads, which in turn implies high capital costs and transmission losses.

New power stations have to be built to ensure that the country's capacity keeps up with demand. In addition, the country's older power stations reach the end of their design life after 2025. South Africa will, therefore, need to access and use all natural resources to produce the additional 40,000

FIGURE 1  
**Schematic of a Process Heat Plant**

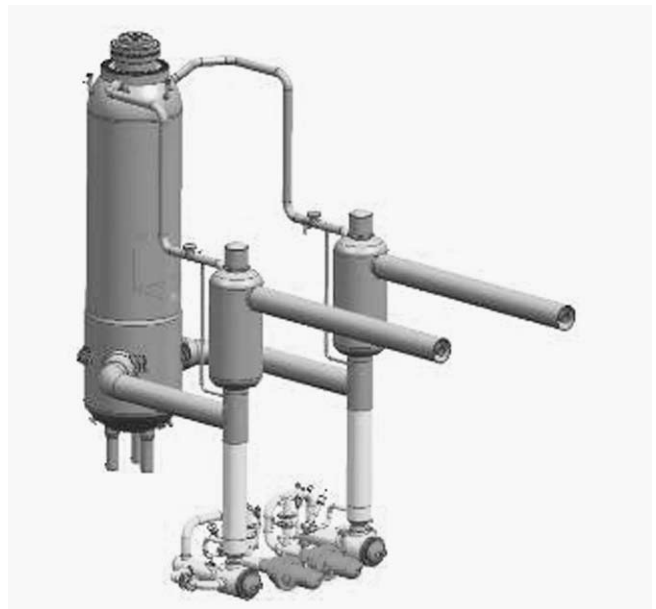

PBMR Ltd.

MW of electricity that will be needed over the next 20 years (over and above the currently installed 39,000 MW).

A typical coal-fired power station requires a construction lead time of about eight years, and could result in the installation of surplus capacity if economic growth is not as expected. Shorter lead times would enable power utilities to drastically shorten their decision-making horizon for the addition of new capacity, and to add capacity in smaller increments.

The South African electricity utility Eskom, like most utilities worldwide, also experiences short, sharp demand peaks in Winter that are difficult to accommodate with the slow ramping characteristics of the existing large power stations.

These factors prompted Eskom to investigate small electricity generation plants that can be placed near to the points of demand. The PBMR concept, which has a 24-month construction time (from first concrete to fuel load), low operating cost, and fast load-following characteristics, is such an option. While open-cycle gas turbines, coal-fired plants, and conventional nuclear reactors are all good options in the short and medium term, the PBMR could play a crucial role to help meet the country's energy requirements from the second half of the next decade onwards. Its inherent safe characteristics and positive attributes from an environ-



PBMR Ltd.

*Koeberg near Cape Town, South Africa: the site earmarked for the first commercial scale pebble bed modular reactor.*



FIGURE 2

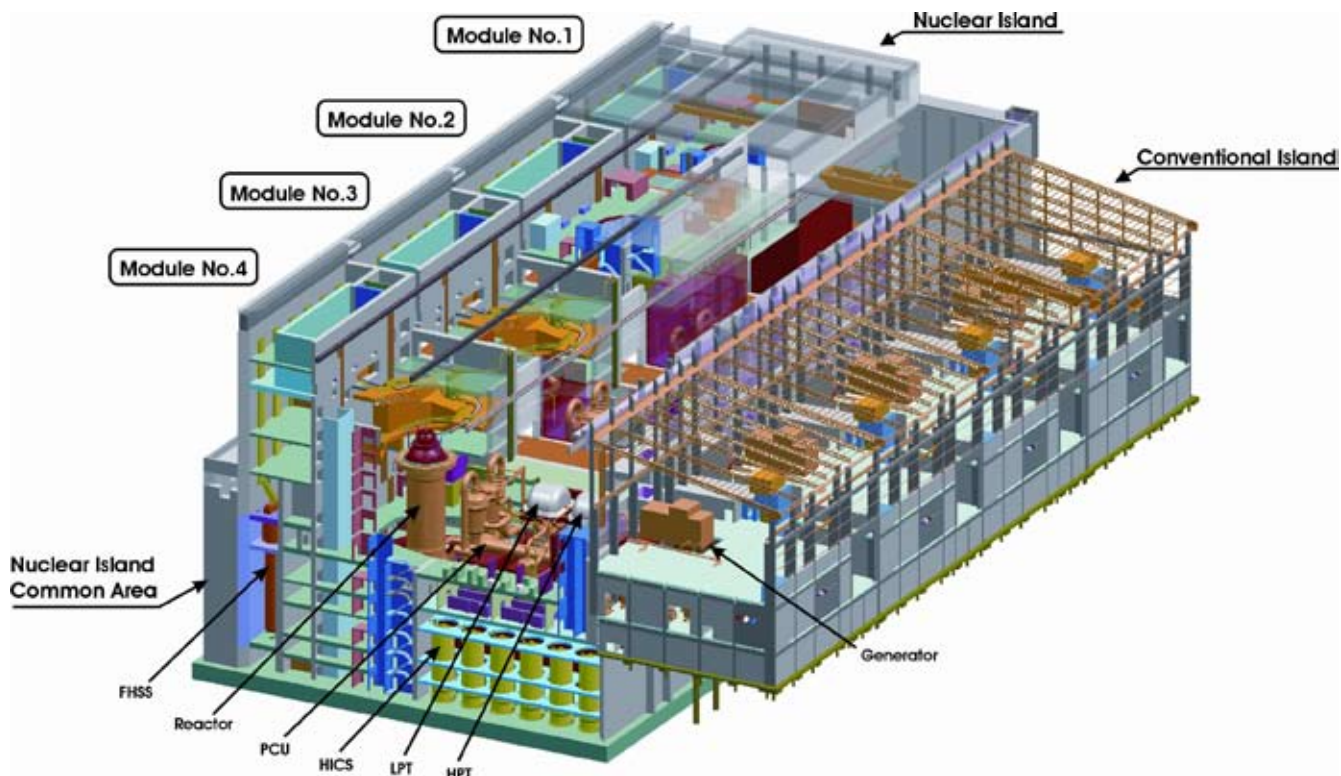

PBMR Ltd.

The PBMR modules are sized to produce 165 MWe. To maximize the sharing of support systems, however, the PBMR has been configured into a variety of options, such as a four-pack layout. This is the most cost-effective layout, and allows the plants to be brought on line as they are completed.

mental point of view, add immensely to the attractiveness of this technology.

It is therefore envisaged that at least 20% of Eskom's new nuclear build program of 20,000 MW will consist of PBMRs (between 24 and 30 modules generating 165 MW each).

## Project Status

Since its establishment in 1999, Pebble Bed Modular Reactor (Pty) Ltd has grown into the largest nuclear reactor design team in the world. In addition to the core team of some 700 people at the PBMR head-office in Centurion near Pretoria, more than a thousand people at universities, private companies, and research institutes are involved with the project. Around the world, scientists and governments are looking to South Africa with great interest to see how the local nuclear reactor developments unfold.

The PBMR team is currently preparing for the building of a commercial-scale power reactor project at Koeberg, near Cape Town, where Africa's only nuclear power station is based, and a fuel plant at Pelindaba near Pretoria. The current schedule is to start construction in 2009 and for the first fuel to be loaded four years later. Construction of the first commer-

cial PBMR modules is planned to start three years after the first fuel has been loaded into the demonstration reactor.

## Investors

PBMR's current investors, the South African government, the South African electricity utility Eskom, the Industrial Development Corporation of South Africa, and the American nuclear giant Westinghouse, share the vision of small, standardized, inherently safe, modular reactors as one of the best carbon-free alternatives for new power-generation capacity around the world.

Westinghouse's decision to become a shareholder in PBMR, is a clear indication of the confidence in the pebble bed technology's technical, commercial, and export potential. The PBMR project also enjoys solid support from the South African government, which regards it as one of the most important capital investment and development projects yet undertaken in the country.

## Process Heat Applications

While PBMR's research and development efforts were initially focused mainly on electricity generation, it has be-

FIGURE 3  
PBMR Schematic

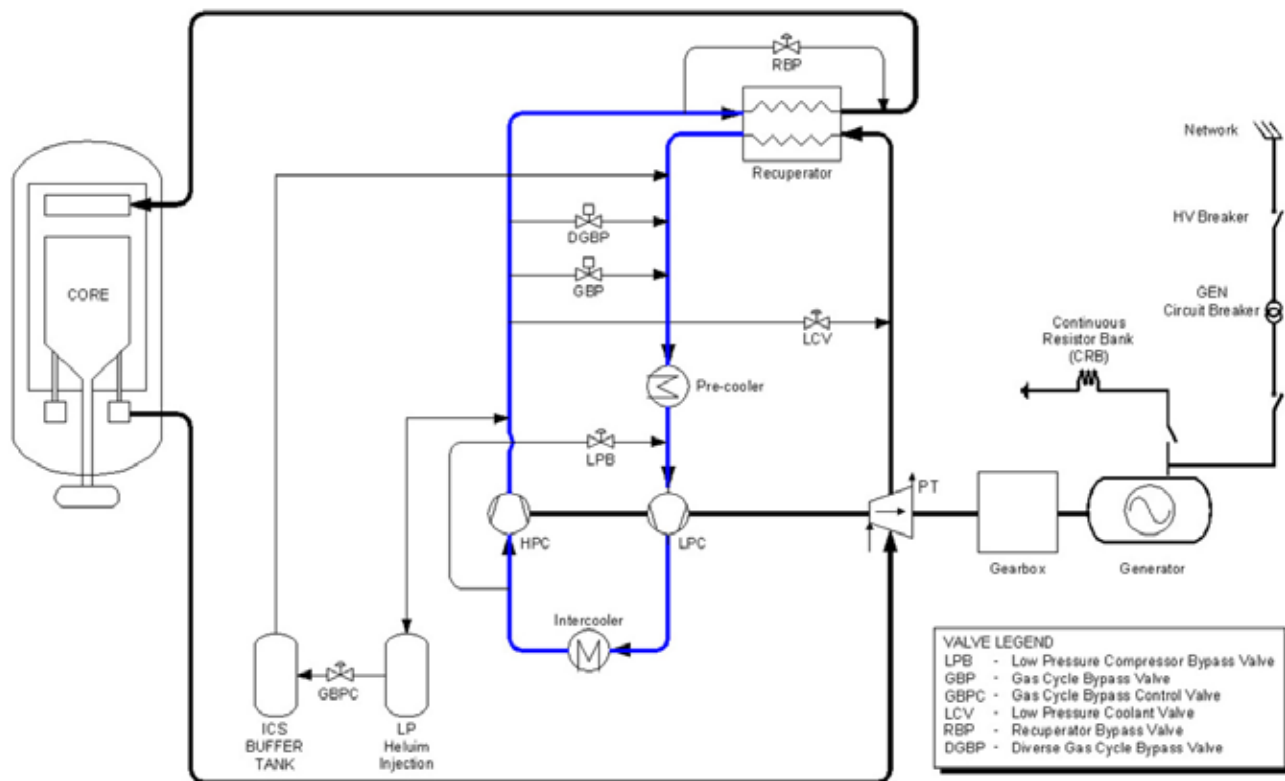

PBMR Ltd.

come increasingly apparent that the high-temperature, gas-cooled reactor technology will also enable access to markets that call for process heat applications. Next-generation high-temperature reactors such as the PBMR can produce hydrogen for transportation or for upgrading coal and heavy crude oils into usable products, thereby relieving pressure on natural gas supply (the source of most hydrogen produced today). They can also generate process heat for desalination, to extract oil from tar sands, and for many other industrial applications.

Capable through its very high temperatures of 900°C, the PBMR technology is ideally placed for these applications.

To this end, the South African synthetic fuels company Sasol is in discussion with PBMR to explore the possibility of replacing its coal-fired boilers with reactors. Sasol has also had preliminary discussions with the government about the potential for PBMR technology and how it can be used in the synfuels industry. It is not inconceivable that such a nuclear heat supply system could be operating by 2015.

In Canada, there is interest from companies involved in the oil sands business, to use the high temperatures created in PBMRs to create extremely super-heated steam to extract bitumen from oil sands, instead of gas-fired plants currently in use.

PBMR is also a partner in a concept design contract with

the U.S. Department of Energy, to consider the PBMR technology as a future source of hydrogen. The project is still in its pre-conceptual phase, but it could result in the construction of a South African-designed Pebble Bed Modular Reactor in the U.S. before the end of the next decade.

The PBMR technology, furthermore, has desalination properties. To this end, the Department of Water Affairs has requested PBMR to work on a proposal for utilizing the waste heat of the demonstration reactor at Koeberg for desalination purposes.

### Small Size

The PBMR is based on the philosophy that the new generation of nuclear reactors should be small. Each module would be sized to produce 400 MWt (165 MWe nominal), which is about 18% of the output of conventional reactors such as the ones at Koeberg near Cape Town.

The main building and generator of a module will cover an area of about 4,320 m<sup>2</sup> (108 m × 40 m), which means that two modules would fit on a soccer field. The height of the building will be 66 m, more than a third (23 m) of which will be below ground level.

The PBMR is being designed in a modular fashion to allow for additional modules in accordance with demand. Dry

FIGURE 4  
Fuel Spheres

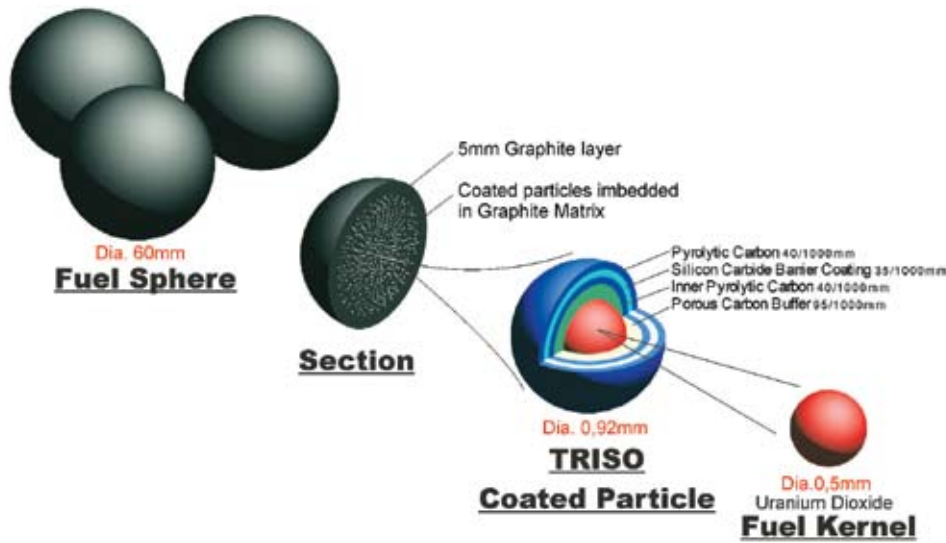

PBMR Ltd.

cooling, although more expensive, is an option that would provide even more freedom of location. In addition, the PBMR can be used both as a base-load or load-following station, and can be configured to the size required by the community it serves. The technology is also well suited for hydrogen production, district heating, and desalination purposes.

### Safety Features

The PBMR has a simple design basis, with inherent safety features that require no human intervention, and which cannot be bypassed or rendered ineffective in any way.

If a fault occurs during reactor operations, the system, at worst, will shut down and merely dissipate heat on a decreasing curve, without any core failure or release of radioactivity to the environment.

The helium, which is used to transfer heat from the core to the power-generating gas turbines, is chemically inert. It cannot combine with other chemicals or elements and is non-combustible.

The inherently safe design characteristics of the PBMR render obsolete the need for safety backup systems and most aspects of the off-site emergency plans required for conventional nuclear reactors. It is also fundamental to the cost reduction achieved over other nuclear designs. Although plans related to aspects such as the transport of fuel will still be required, they will be modified to suit the specific characteristics of the fuel and the transport mode.

The reactor core concept is based on the well-

tried and proven German AVR power plant, which ran for 21 years. This safe design was proven during a public and filmed plant safety test, when the flow of coolant through the reactor core was stopped and the control rods were left withdrawn just as if the plant were in normal power generation mode.

It was demonstrated that the reactor core shut itself down inherently within a few minutes. It was subsequently proven that there was no deterioration over and above the normal design failure fraction of the nuclear fuel. This proved that a reactor core meltdown was not credible, and that an inherently safe nuclear reactor design had been achieved.

FIGURE 5  
Schematic of the Power Conversion Unit

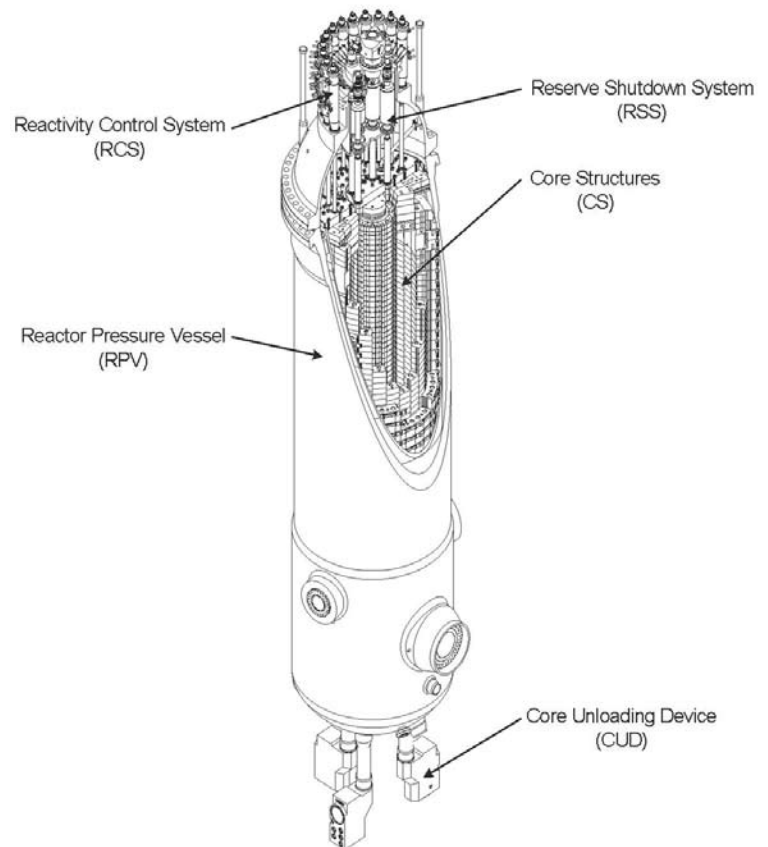

PBMR Ltd.

## Spent Fuel Management

A 165 MWe PBMR module will generate about 32 tons of spent fuel pebbles per annum, about one ton of which is uranium. The storage of PBMR spent fuel is much easier than for fuel elements or rods from conventional nuclear reactors, as no safety graded cooling systems are needed to prevent fuel failure.

The PBMR system has been designed to deal with nuclear waste efficiently and safely. There will be enough room for the spent fuel to be stored in dry storage tanks at the PBMR plant for the power station's expected 40-year operational life, during which time no spent fuel will have to be removed from the site. After the plant has been shut down, the spent fuel can be safely stored on site for another 40 years before being sent to a final repository.

## How the PBMR Works

The PBMR is a helium-cooled, graphite-moderated, High-Temperature Reactor (HTR). It has a 27 m (88 ft) high vertical steel Reactor Pressure Vessel (RPV) with an inner diameter of about 6.2 m (20 ft). The RPV contains and supports a metallic core barrel. The core barrel, in turn, supports the annular pebble fuel core, which is located in the space between a central and outer graphite reflector. Vertical borings in these reflectors are provided for the reactivity control elements.

Two diverse reactivity control systems are provided for shutting the reactor down. One of the systems is 24 control rods in the outer reflector, while the other consists of small absorber spheres which are dropped into eight borings in the central reflector.

The PBMR uses particles of enriched uranium dioxide coated with silicon carbide and pyrolytic carbon. The particles are encased in graphite to form a fuel sphere or pebble about the size of a billiard ball. Helium is used as the coolant and energy transfer medium, to drive a closed cycle gas turbine-compressor and generator system. When fully loaded, the core would contain approximately 450,000 fuel spheres.

To remove the heat generated by the nuclear fission reaction, helium coolant enters the reactor vessel at a temperature of about 500°C (932°F) and a pressure of 9 MPa or 1,323 pounds per square inch (psi). The gas flows down between the hot fuel spheres, after which it leaves the bottom of the vessel having been heated to a temperature of about 900°C (1,652°F).

The hot gas then enters the turbine, which is mechanically connected to the generator through a speed-reduction gearbox on one side and the gas compressors on the other side. The coolant leaves the turbine at about 500°C (932°F) and 2.6 MPa (377 psi), after which it is cooled, recompressed, reheat-

FIGURE 6  
The PBMR Power Conversion Unit

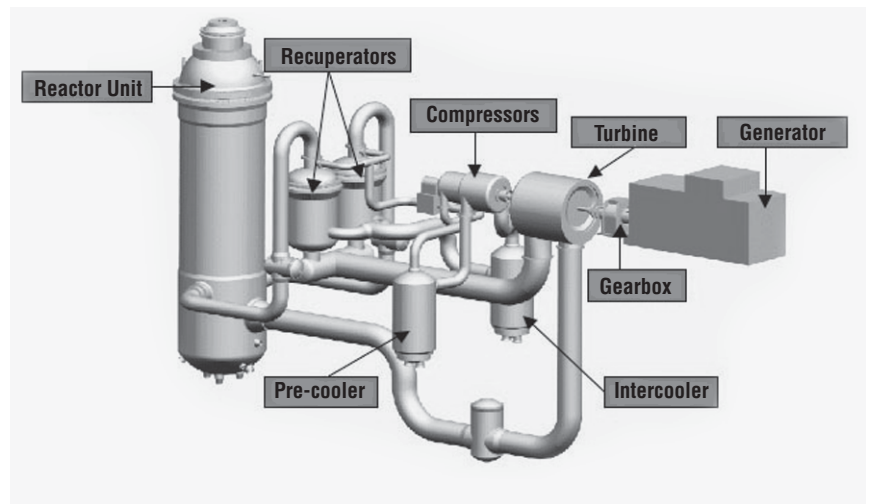

PBMR Ltd.

ed, and returned to the reactor vessel.

The thermodynamic cycle used is a Brayton cycle with a water-cooled pre-cooler and intercooler. A high-efficiency recuperator is used after the power turbine. The helium, cooled in the recuperator, is passed through the pre-cooler, low-pressure compressor, the intercooler and high-pressure compressor, before being returned through the recuperator to the reactor core.

The power taken up by the helium in the core and the power given off in the power turbine is proportional to the helium mass flow rate for the same temperatures in the system. The mass flow rate depends on the pressure, so the power can be adjusted by changing the pressure in the system.

The high-pressure and high-temperature operation of the reactor results in a relatively high thermal efficiency. While a typical light-water reactor has a thermal efficiency (electrical power output/thermal heat input) of approximately 33%, an efficiency of about 41% is anticipated in the basic PBMR design.

Online refuelling is another key feature of the PBMR. Fresh fuel elements are added to the top of the reactor, while used fuel is removed at the bottom while the reactor is at power.

The aim is to operate uninterrupted for six years before the reactor is shut down for scheduled maintenance. However, for the demonstration module, a number of interim shutdowns will be required for planned evaluation of component and system performance.

Shutdown will be done by inserting the control rods. Start-up is effected by making the reactor critical, then using nuclear heat-up of the core and circulating the coolant by motoring the turbo-generator set. Heat is then removed by the pre-cooler and intercooler. At a specified temperature, the cycle becomes self-sustaining.

## The City of London

*The city within a city is a medieval place, and the evil center of the British Empire.*

In terms of evil per square mile, it would be difficult to find any place on Earth worse than the City of London. By the City, we mean not metropolitan London, but that ancient Venetian parasite which sits at its medieval core, the self-governing enclave known as “the City” or “the Square Mile.”

The City has its own ruling body, the City of London Corporation, with its own Lord Mayor, aldermen, council, and police force. To be a member of the Court of Common Council, the primary decision-making assembly, one has to be either a British subject or a citizen of one of the European Union countries, and be a “Freeman of the City of London.” Freeman is a medieval term which means that an individual is not the property of a feudal lord, and the City is a “free city” only in the sense that it is independent of the dominion of the landed aristocracy.

Modern Britain, if you’ll pardon the term, is the result of an alliance between the Venetian rentier-financier oligarchy and the Norman landed aristocracy. The landed aristocracy made its money by owning the land and everything on it, including the peasants, while the Venetians made their money through trade and its financing. Both systems depended upon monopolies, of either land or trade, and through exploitation of the “commoners.” While Britain remains a feudal state, with the ruling class owning vast tracts of land, the City was and remains the province of the Venetian financiers, a city controlled by the money men who, more than the landed aristocracy, are the

black heart of the British Empire.

The structure of the City is freemasonic, a power structure based upon ritualistic institutions such as the livery companies—the successors to the ancient craft guilds—with names like The Worshipful Company of Mercers and The Worshipful Company of Fishmongers—and the noble and chivalric orders—the knights and such—which serve to indoctrinate young men in the fetishes of the City, and thus ensure the survival of the financier ideology.

The financial side of the City historically revolved around the merchant banks—Barings, Coutts, Kleinwort Benson, Warburgs, Schrodgers, and Rothschild, among the more recognizable names—and around insurance institutions such as Lloyds of London and banks like Barclays and the Royal Bank of Scotland. Behind them all was the dope-pushing, slave-trading British East India Company, the financier-trading company which spawned the British Empire and the power of the City. The power of the City was based upon the ability of the empire to dominate both the trade in goods and the financing of that trade, across the globe.

A good example of how this worked was the cotton-opium-tea trade. The Brits would take cotton grown by slaves on the plantations of the Old South in the U.S., turn that cotton into textile products in sweatshops in England, then sell some of those textiles in the Crown Colony of India, in exchange for opium, which they would then sell to the Chinese for tea, so that the Lords and Ladies of the

Empire could enjoy their tea and crumpets, and cluck about the difficulties of running the world. When the Chinese complained about this arrangement, the British Empire forced the opium on China at the point of a gun, all in the name of defending the lifestyle of the “free men” of the City.

The structure of the City changed dramatically with the “Big Bang” in 1986, as the financiers who run it broke up the clubby, inbred system and opened the doors, in preparation for the frenzy of globalization which followed. During the 1990s, London became the center of the global derivatives market, the place where U.S., European, and other banks did things they would not do at home. Most of the old-line British merchant banks were sold off to better capitalized partners: S.G. Warburg to Swiss Bank Corp.; Kleinwort Benson to Dresdner Bank; Hambros to Société Générale; and Schrodgers to Citigroup, to name a few, as the insular little club transformed itself into the center of global speculation, aided by its bevy of offshore banking centers.

Now the speculative bubble has popped, and the City is headed for another transition, as it adapts to remain on top of the pile. The new model is, as in the past, based upon corporate cartels which control the production and distribution of raw materials such as metals, minerals, and petrochemicals, the control of food supplies, and the privatization of roads, water supplies, and other essentials. These financier-controlled cartels plan to use financial middlemen to jack prices up on these items, along the lines of what Enron did to electricity rates in California and the oil companies are doing to gas prices today. These “market” prices will be set high enough to make money, while ensuring that a portion of the population cannot afford them, and will die.

---

# Business Briefs

## **Nuclear Power**

---

### **IAEA Promotes Pebble-Bed Reactors**

---

Speaking to a reporter on the sidelines of a nuclear power conference in Shanghai, China, Yury A. Sokolov, the IAEA's deputy director general, said he expected safety and efficiency gains from the next generation of nuclear reactors—known as “pebble bed modular reactors”—which use gas as a neutron moderator. South Africa and China are both pushing development of the experimental technology, though neither has yet started construction of a commercial plant. “This is our future,” Sokolov said of the PBMR plants.

Sokolov said the pebble bed reactor would increase the ratio of electrical to thermal output from 33-35% to 50-60%, and could make the use of uranium more efficient, extending the life of the fuel. The gases do not dissolve contaminants or absorb neutrons as water does, so the core would have less radioactive material and be more economical than a light-water reactor, he said.

## **Currency**

---

### **Asians Dump Dollar At Record Rates**

---

Chinese and Japanese sales of U.S. treasuries grew in August “at a pace unprecedented in the last five years, as the U.S. subprime mortgage crisis triggered the biggest sell-off of dollar assets since Russia’s 1998 default,” according to the *China Daily*. China cut its holdings of U.S. treasuries by 2.2% or \$9 billion, to \$400 billion, while Japan dumped 4% of its holdings (the most since March 2000), bringing its total down to \$586 billion. Taiwan’s holdings of U.S. government bonds fell by 8.9% to \$52 billion.

According to the latest statistics, \$400 billion of U.S. treasuries now account for only 28% of China’s \$1.43 trillion foreign reserves, in sharp contrast to previous years when most of China’s foreign reserves were in U.S. treasuries. *China Daily* cited analysts

who attributed the rapid exit from the dollar, to the low exchange rate caused by the subprime mortgage fallout, and the U.S. Federal Reserve’s decision to lower the interest rate by 50 basis points, both of which are symptoms of the collapsing dollar-based monetary system. The dollar has lost about 7% this year against the euro. Suspicions that the Fed would cut the interest rate again contributed to further pressure for China and other countries to reduce holdings of U.S. assets.

China’s State Administration of Foreign Exchange told a conference that foreign exchange management departments should move against hot money flows, by “regulating foreign capital inflow and foreign exchange management, preventing illegal capital inflow and short-term overseas speculation, to ensure the national financial security.”

## **Speculative Investments**

---

### **Italy Investigates Derivatives in Regions**

---

The Milan Prosecutor’s Office has opened a criminal investigation of financial derivatives deals between the Lombardy regional government and UBS and Merrill Lynch. The financial police seized records of the regional government office on Oct. 18, after a popular TV broadcast on Oct. 14 featured the derivatives bubble which has been built up by regional and local administrations.

The investigation focusses on a “sinking fund,” whereby the Lombardy money is managed by UBS and Merrill Lynch, but the investment risk is borne entirely by the customer (in this case, the regional administration).

The Finance Committee of the Chamber of Deputies will start hearings on the regional derivative bubbles at the end of October.

It is expected that a bipartisan amendment to the current budget law will be proposed, according to which no local administration will be allowed to purchase a derivatives contract without authorization from the Finance Minister or another supervising authority. The amendment will be proposed by Senators Cinzia Bonfrisco and

Giovanni Legnini.

Legnini has called for an “evaluation of financial products proposed to local administrations, through the office of the Finance Ministry, about risk profiles of the contract to be signed,” by the Senate Budget Committee.

The senators are considering introducing a cap of 10% of derivatives relative to the local administration’s total debt financing, along with risk-sharing with the banks.

## **Free Trade**

---

### **Mexicans Are Starving Thanks to NAFTA**

---

As a result of the imposition of the North American Free Trade Agreement (NAFTA) in 1993, combined with almost a quarter-century of the IMF’s “structural adjustment” policies, 20% of Mexicans suffer from hunger, according to the country’s Social Development Secretary. This, in a country that was once self-sufficient in food production.

In rural areas, the hunger figure shoots up to 40%, while among largely indigenous populations, it is 60%. And statistics indicating 8,000 infant deaths annually due to extreme malnutrition, is certainly inaccurate, given that official statistics aren’t even kept in the rural areas of such poorer states as Guerrero, Chiapas, Yucatan, and Oaxaca. In the Chiapas highlands alone, 153,000 children under the age of five are threatened with severe malnutrition.

Economist José Luis Calva of the National Autonomous University (UNAM), reports, in the Oct. 18 *El Universal*, on the shocking 93% decline in public investment in agriculture that occurred between 1980 and 2006. The Mexican Food System that existed under President José López Portillo to combat hunger and malnutrition was abandoned by successor governments.

Farm leaders warn that the next phase of NAFTA, starting in January, will flood the country with cheap U.S. food imports. It will mean “the kiss of death” for the nation’s agricultural sector, forcing even more people off the land and out of the country in search of jobs in the United States.

## THE FIGHT FOR THE REPUBLIC

# James Fenimore Cooper and The Society of the Cincinnati

by Patrick Ruckert

*Editor's Note: This is the first in a series of articles on the American patriotic tradition, and its historical enemy, the European (British/Venetian) oligarchy. The purpose is to inject the issue of the American System, and the quality of republican leadership and culture that must be revived, into the political process. As of now, none of the purported Presidential candidates of either party has exhibited the quality of leadership required to deal with the onrushing collapse of the global financial system, the persistent war danger coming from London and from such London assets as Dick Cheney, and the myriad other crises confronting the nation and the world. We are going to need a quality of leadership from the next President that is so far lacking among the current crop of contenders.*

*Through this effort, we intend to create the conditions for a genuine American patriotic candidate to emerge. Who is the now-unknown American patriot? That question cannot be answered at this moment, but we have the longstanding tradition, promoted by Founding Father Benjamin Franklin, of the wide dissemination of patriotic writings, that we will draw upon. Of special relevance is the period of the early 19th Century, when patriots had to fight the treasonous role of the Jackson-van Buren gang which had sabotaged the American System model of economics. Thus, we turn first to James Fenimore Cooper as exemplary of the patriotic forces fighting for republicanism against oligarchism.*

*The following article was first published in the Sept. 29, 1989 New Federalist newspaper. It has been updated, and edited for EIR.*

Whenever the government of the United States shall break up, it will probably be in consequence of a false direction having been given to public opinion. This is the weak point of our defences, and the part to which the

enemies of the system will direct all their attacks. Opinion can be so perverted as to cause the false to seem true; the enemy, a friend, and the friend, an enemy; the best interests of the nation to appear insignificant, and trifles of moment; in a word, the right the wrong, and the wrong the right. In a country where opinion has sway, to seize upon it, is to seize upon power. As it is a rule of humanity that the upright and well-intentioned are comparatively passive, while the designing, dishonest and selfish are the most untiring in their efforts, the danger of public opinion's getting a false direction is four-fold, since few men think for themselves.

—James Fenimore Cooper,  
*The American Democrat*, 1838

Again and again, Lyndon LaRouche has made the point that nations and cultures are destroyed, not by evil leaders, but by wrong or false beliefs, adopted as popular opinion by that nation's population. Should such false beliefs—ways of thinking about what it means to be human, how to organize an economy, what is a healthy culture—hold sway, then such a population has set itself on the path to its own destruction.

The story that follows is the story of a great American patriot, James Fenimore Cooper (1789-1851), and his fight to save the American Republic; and how the enemies of this nation, and what it represented for all humanity, saw in Cooper a man who had “constituted himself the literary antagonist of the monarchy, aristocracy, and feudality of all Europe, and particularly England.”

In the decades following the American Revolution and the adoption of the Constitution, the quality of mind and intellect, which allowed for those events to succeed, was gradually undermined. Whereas the Founding Fathers were the intellectual giants of their era, with important but few exceptions, the suc-



*James Fenimore Cooper took up his pen to save the republic that his father's generation had created; he did so, not only as the most widely read writer of his time, but also as a leader of the American secret intelligence service--the Society of the Cincinnati--during the second quarter of the 19th Century (portrait by John Wesley Jarvis).*

ceeding political leadership of the nation increasingly sank lower and lower into mediocrity, or downright evil. Recognizing this trend, and determined to reverse it, Cooper took up his pen to save the republic that his father's generation had created by waging war on stupidity, ignorance, treachery, and cowardice. He did so, not only with his pen, but also as one of the key leaders of the American secret intelligence service during the second quarter of the 19th Century. As a result, Cooper, like LaRouche, was seen by the enemies of the United States as a clear danger to their plans to destroy our republic.

The fact that only a handful of Americans know Cooper's story today is testimony to the fact that those who control the media, the education, and the literature of our country, still consider him to be a dangerous threat to their evil intentions, nearly two centuries after his death. In fact, if Cooper is known at all, it is mainly as the author of a series of frontier adventure novels called *The Leatherstocking Tales*.

But, as LaRouche has written: "The principal function of most of Cooper's published writings, which were composed in the conceptual form of Classical drama, was to inform Americans on how to look at foreign and domestic situations in which we confront our republic's enemies."

### **The First Generation: William Cooper**

James Fenimore Cooper, born on Sept. 15, 1789, grew up in the midst of the men who had made the American Revolu-

tion and wrote the Constitution of the United States. His father, William Cooper, served under George Washington in the Continental Army. After the war, Washington directed Cooper to move to upstate New York to establish frontier settlements of patriotic Americans. Washington's plan at the time was to make Albany, New York the capital of the United States. By so establishing a populated center near the Canadian border, Washington knew that the threat from British-controlled Canada to re-impose its colonial rule would be lessened.

The senior Cooper became a leading figure in developing the frontier and was the founder of Cooperstown, New York. He wrote several books on establishing settlements, and was one of the earliest proponents for constructing the Erie Canal.

Two of his closest friends were John Jay and Alexander Hamilton, authors of *The Federalist Papers*, a series of articles authored by Hamilton, Jay, and James Madison in 1787-1788, which explained and argued for the adoption of the U.S. Constitution. Today they are still one of the most important and profound works on republican ideas, principles, and institutions ever written. Jay's son, Peter, was James Fenimore's life-long friend, associate, and fellow leader of the second generation of American republicans. Hamilton, George Washington's second-in-command during the Revolutionary War, was William Cooper's lawyer during attempts by British land companies to steal millions of acres of forest land in upper New York State. Appropriately, the lawyer for the British was the traitor Aaron Burr.

William Cooper also served in the Congress. In 1809, he was murdered by associates of Burr, just five years after Burr himself had murdered Hamilton in a duel.

### **The Society of the Cincinnati**

In the years following the end of the Revolutionary War (1783) and the adoption of the Constitution (1789), the British-led oligarchy still hoped to reverse their defeat. In order to meet the challenge posed by the British, the Revolutionary War leadership had established a private, political intelligence organization aimed at not only protecting the young republic, but also, replicating its achievements on a world scale. The Society of the Cincinnati was founded in May 1783 by Baron von Steuben, Samuel Verplanck, Washington, and Hamilton. France's Marquis de Lafayette founded the European branch of the Society, and along with, especially, German republican forces, created the network, of which, 40 years later, James Fenimore Cooper would be a leader.

By 1815, despite the sweeping rout of republican forces and institutions in Europe, which the Congress of Vienna celebrated, the American defeat of England in the War of 1812 created a resurgence of the United States, and an aggressive intervention into Europe by the republican forces of the Society of the Cincinnati, which continued into 1832. Though defeated in Europe, the ideas generated by the American Revolution, the great German poet of freedom Friedrich Schiller,



the vom Stein-Humboldt reforms of 1809-1813, and so forth, had embedded the republican spirit deeply in the German people, among others in Europe.

The objective of the Congress of Vienna was to eradicate this republican spirit and the ideas of the American Revolution, along with the American republic itself, from this planet, before the system of wealth and power of the feudal oligarchy itself was eradicated. The Holy Alliance set in motion new ventures to accomplish this task. While maintaining a ruthless suppression of republican ideas, the Holy Alliance also launched an all-out assault on the culture and intellectual traditions of the American Revolution and German Classicism.

England, for example, flooded both countries with the feudalism-worshipping novels of Sir Walter Scott. Scott was not only a leading figure of the fascist Romantic movement; he directly deployed against Cooper and his network in Paris in 1830-31.

### Cooper and the Spread of Republicanism

In the United States, James Fenimore took up his pen in the 1820s to defend his country. He began writing novels that expressed American principles. As he said in his *Notions of the Americans*, in 1829, the demonstration of these principles was the principal duty of an American author:

The literature of the United States is a subject of the highest interest to the civilized world; for when it does begin to be felt it will be with a force, a directness, and a common sense in its application, that has never yet been known. If there were no other points of difference between this country and other nations, those of its political and religious freedom, alone, would give a color of the highest importance to the writings of a people so thoroughly imbued with their distinctive principles; and so keenly alive to their advantage.

Like any competent leader, Cooper believed that attack was the best defense. And attack he did. Cooper went on to say, that for half a century America had been operating silently on Europe by force of example, but that the time had now come for those authors familiar with America's "doctrines and its experience," to press these upon the world's attention with articulate expression.

"Books," he said, "are, in a great measure, the instruments of controlling the opinions of a nation like ours. They are an engine alike powerful to save or destroy."

Between 1815 and 1824, the British spy, Sir Walter Scott, exerted a dominant influence on German literature. By 1824, the year Cooper's second novel, *The Spy*, was published in Germany, Scott was quickly pushed aside; and not only in Germany. In fact, Cooper became, in just a few years, the most widely read author in the world. His works were translated into French, German, Italian, Spanish, Polish, Russian,

Hungarian, and even Persian. Clearly, as he had forecast, the world was thirsting for American literature and ideas.

The *Paris Glove*, in 1827, wrote: "Cooper portrays solitary heroes who exercise the height of human virtues and human potentialities. He shows us the promise of a new civilization in which laws are the guarantees of human liberty. In the pages of Cooper we see the political revolution, which made such a society possible, and we witness the progress of settlements, which are bringing it to fruition. Unlike Walter Scott, who hides his lack of principle behind a ruse of objectivity, Cooper proclaims his faith in liberty, country, and the dignity of human nature. Cooper represents to the European reader the very type of noble American republican."

Samuel F.B. Morse—Classical painter, inventor of the telegraph, and Society of the Cincinnati agent—writing from abroad to a friend in America, said: "I have visited, in Europe, many countries, and what I have asserted of the fame of Mr. Cooper I assert from personal knowledge. In every city of Europe that I have visited, the works of Cooper were conspicuously placed in the windows of every book-shop. They are published as soon as he produces them in thirty-four different places in Europe. They have been seen by American travelers in the languages of Turkey and Persia, in Constantinople, in Egypt, at Jerusalem, at Isphahan."

In Germany, more than 100 editions of his most well-known novels were published between 1826 and 1914, while complete sets of his books were issued at least a dozen times. Among school children, the *Leatherstocking Tales* was read by Germans at least as much as by Americans. Titles of his books became German household words. In the early part of this century the German Boy Scouts were called "*Die Pfadfinder*," and the last bottle of wine at an evening drinking party was called "*Der letzte Mohikaner*."

During the 50 years following the 1815 Treaty of Vienna, millions of Germans fled the tyranny of the Holy Alliance by migrating to the United States. Nearly every German knew someone in America. Thus, Cooper's books were important for those going to America, and for their friends and relatives left behind. During the American Civil War, many of these Germans played leading roles in the victory of the North.

Cooper's book, *Notions of the Americans*, commissioned by American Revolutionary War hero, and Society of the Cincinnati member, the Marquis de Lafayette, in 1828, was the most important of Cooper's works in directly communicating knowledge about America and its republican ideas. Written in the popular form of a travel book, it describes America, its people, institutions, history, heroes, its cities, and industries. Echoing the ideas of the *Federalist Papers*, this book was a powerful tool for republicans, and was used as such during the European revolutions of 1828-1832.

Cooper had a direct influence on some of the best-known writers of Europe, such as Johann Wolfgang von Goethe (1749-1832). Goethe was fascinated with America, and, after 1816, regularly received American visitors. He studied Amer-



Library of Congress

*The Pilot*



FOC Darley

*The Bravo*

do not remember a stronger conviction of the superiority enjoyed by true over factitious greatness, than that which flashed on my mind when I was told this fact [that he was viewing Schiller's birthplace—ed.]. That sequestered hamlet rose in a moment to an importance that all the appliances and souvenirs of royalty could not give to the palace of Ludwigsberg. Poor Schiller! In my eyes he is the German genius of the age. Goethe has got around him one of those factitious reputations that depend as much on being a coddled celebrity—for you must know there is a fashion in this thing, that is quite independent of merit—while Schiller's fame rests solely on its naked merits. My life for it, that it lasts the longest, and will burn brightest in the end. The schools, and a prevalent taste and the caprice of fashion can make Goethes in dozens, at any time; but God only creates such men as Schiller.

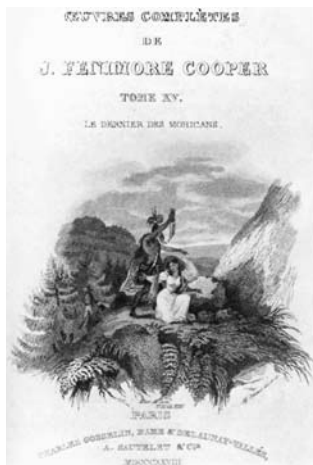

*The Last of the Mohicans*  
(French edition)



*The Leatherstocking Tales* (German edition)

*Cooper's works were translated, published, and read throughout the world.*

ican geography, culture, government, and exploration reports, and said in 1819 that had he been younger, he would have emigrated to the United States. He read *The Pioneers*, *The Last of the Mohicans*, *The Spy*, *The Pilot*, *The Prairie*, and *Red Rover* in the period between 1826 and 1828.

A popular tale, which took Goethe 30 years to complete, and is known as the “Novelle,” included whole sections all but copied from Cooper's *The Pioneers*.

### ‘God Only Creates Such Men as Schiller’

While Goethe may have been influenced by Cooper, Cooper had no illusions about Goethe, as seen in the following statement, which Cooper made after seeing the birthplace of Friedrich Schiller in Marbach, Germany:

Few men can feel less of the interest that so commonly attaches to the habits, habitations, and personal appearance of celebrated men, than myself. The mere sight of a celebrity never creates any sensation. Yet I

humanity, so that mankind would be equipped to create an age of reason. Cooper personally financed young American artists studying the Old Masters in Europe, like the sculptor, Horatio Greenough, whose bust of George Washington can be seen on the Mall in Washington, D.C. today. Cooper had written, in *Notions of the Americans*, that the practical cares of life had held back real artistic development in America. Yet the talent is there, he said: “It wants training and a push to bring it forth.”

Later in that book, he writes: “The purely intellectual day of America is yet in its dawn.” His optimism and faith in creating an American Renaissance was explicit: “We live in the excitement of a rapid and constantly progressive condition. The impetus of society is imparted to all its members, and we advance because we are not accustomed to stand still.” And, “Our prosperity is owing to our intelligence, and our intelligence to our institutions. Every discrete man in America is deeply impressed with the importance of diffusing instruction among our people.” Cooper demonstrates his determination

to carry out the objectives of the Society of the Cincinnati, in his conclusion to *Notions of the Americans*:

A new era is now about to dawn on this nation. It has ceased to creep; it begins to walk erect among the powers of the earth. All these things have occurred within the life of man. Europeans may be reluctant to admit the claims of a competitor, that they knew so lately a pillaged, a wronged, and a feeble people; but nature will have her laws obeyed, and the fulfillment of things must come. The spirit of greatness is in this nation; its means are within its grasp; and it is as vain as it is weak to attempt to deny results that every year is rendering more plain, more important, and more irresistible.

### Cooper and Lafayette Lead European Revolts Against the Holy Alliance

Cooper arrived in Europe in 1826. Based in Paris with Lafayette, he coordinated the work of other Americans, like Samuel Morse and Edgar Allan Poe (another member of the Society of the Cincinnati), throughout Europe. In 1824, John Quincy Adams, a collaborator of the Cincinnati, was elected U.S. President. During Adams' Presidential campaign, Lafayette made a magnificent tour of the United States, helping to ensure Adams' victory. Lafayette's stay in New York during that tour was hosted by James Fenimore Cooper.

Adams had spent many years in Europe on diplomatic missions for the young United States, and knew well the nature of the oligarchy. He personally witnessed, as the U.S. Ambassador to Russia, beast-man Napoleon's occupation of Moscow in 1812.

During 1827 and 1828, Lafayette's home was the headquarters of the European republican movement. Cooper's letters to other Cincinnati members, like Peter Jay, report on meetings with Alexander von Humboldt and many others. Over the next few years, Cooper made an intense study, not only of the contemporary battles he was in the midst of, but of the history of feudalism, monarchy, and aristocracy. He concluded that actual monarchy was dead in Europe. Only a semblance of it remained, he said; and what dominated Europe was a financial oligarchy determined to maintain its feudal order against the American-led republican movement.

It was this activity and study, which led Cooper to write his three novels placed in European settings. His belief that fictional works are "formidable weapons in the cause of morality," was no better demonstrated than in the oligarchy's response to the first of the three novels, *The Bravo*. This book ripped away the popularized myth of the "gentlemanly nature" of the members of the aristocracy. Cooper's insight into the irrational, lawless character of the oligarchical mind, and his ability to vividly portray the struggle between the oligarchy and republicanism in *The Bravo*, places him in the com-



Library of Congress

*The Paris home of Lafayette, hero of the American Revolution and Cincinnati Society member, was the headquarters of the European republican movement. This medallion commemorates Lafayette's contribution to America's War of Independence.*

pany of such great writers as Schiller.

Cooper began writing *The Bravo* in 1830, shortly after a two-week stay in Venice. The title refers to an assassin and spy in the pay of the rulers of Venice. Venice, as Lyndon LaRouche said more than two decades ago, was and is "the worst cesspool in modern history." For centuries, Venice looted the world, created and destroyed empires, and enslaved millions through a highly refined system of manipulation, supported by military force. Internal order and stability in the "Most Serene Republic" was maintained by one of the most ruthless, cruel, cynical, and faceless systems ever devised.

Ten years after the death of Cooper, his daughter Susan Cooper wrote, that when her father first discovered the internal workings of the Venetian political system, it filled him with horror and indignation. For Cooper, the evil of Venice was no abstraction. The real power behind the Treaty of Vienna exuded the stench of the canals of Venice. This city of parasites, was the global center of the oligarchical financial and political power. Two other great republican authors have written about Venice: Shakespeare wrote two plays, *Othello* and *The Merchant of Venice*, and Schiller's *The Ghost-Seer; or, Apparitionist* show how the forces of the evil Venetian oligarchy conspired to destroy a good but weak man.

*The Bravo* presents us with a map of the thinking processes of the oligarchical mind. The sense of individual identity of the oligarch is entirely located in the social structure of the oligarchy itself. Universal principles, or law, neither define the individual's self-conception, nor even any internally defined purpose. He is totally "other-directed"—a mere tool or appendage for maintaining the continuity of the oligarchical system. Thus, for the oligarch, since there is no universal or higher purpose to his individual life—no obligation to

principles, law, or justice—nothing, no matter how bestial or obscene, is forbidden. Of course, one should not embarrass the family with one’s lawless behavior. Thus, the masks worn by the Venetians disguise the perpetrator of evil, while the act is permitted and condoned.

Cooper followed with two more novels depicting the evil nature of oligarchical systems and institutions, *The Heidenmauer* (1832) and *The Headsman of Berne* (1833). *The Heidenmauer* is set in the early 16th Century and depicts the early phases of what became the 1511-1648 religious wars of Europe; it is a virtual textbook on counterintelligence warfare. *The Headsman of Berne* is an examination of the political and social relations in feudal Switzerland.

Cooper was in Germany when the July 1830 revolution broke out in Paris. When he arrived back in Paris in August, the King, Charles X, had been driven from the country, and Louis Philippe had been installed on the throne. Lafayette was the leader of the revolutionary forces and held the position of Commander of the National Guards in the new government. Cooper recognized at once that Lafayette had made a horrendous error in allowing Louis Philippe to be made king, rather than establishing an American-modelled republic on the spot. Though Cooper tried to salvage the situation, by December, Lafayette was out, and the oligarchy’s power was re-established through the duplicity of Louis Philippe.

In a letter to Peter Jay on Sept. 8, Cooper reported on the lost opportunity: “For a few days the old veteran [Lafayette] held the fate of France in his single hand.” Cooper’s letters to Jay, U.S. Naval Commander William Schubrick, and a few others, written during this period, are intelligence reports on the developments throughout Europe; the plans and activities of the enemies of America; profiles of political leaders and recommendations for action by the Cincinnati Society networks.

For example, the following was written to Peter Jay on Sept. 8, 1830, on the developments in France:

It is certain that the revolution here is regarded with a very evil eye, by the English Aristocracy.... I have just had a visit from two Italians.... They tell me to expect important events from that quarter.... At Rome there is great discontent, and all of upper Italy is ready for revolt. Can Austria be neut[ral] in such a state of things? It is true discontent pervades the Tyrol, Hungary, and Bohemia. Saxony is far from satisfied—Poland feels still like a Nation—Half the small German States are tired of their oppressors, and, in short, there is everywhere a tendency to revolt.... In fine, there is need to remodel Europe—to give Italy a national character—to secure civil rights in Germany and to break down a hundred useless and troublesome barriers which now exist—to bring people under the same government who have common interest and sympathies....

I have just seen letters from Constantinople. They say that the Turks look for the intervention of England in the affair of Algiers, and that they hope to regain their lost ascendancy over the African regencies. Our agents complain, THERE AS THEY DO EVERY WHERE ELSE of the English influence being used against us. Of this fact be assured there is not a shadow of doubt. As a nation, and often as individuals they do us all the harm they can” (emphasis in original).

The remainder of this very long letter reports on the intelligence he gathered on the British direction behind the South Carolina secessionist movement; and other political developments in the United States.

During the Winter of 1831-1832, Cooper’s house in Paris was “the nucleus of republican sympathies in the great capital.” Samuel Morse and the American sculptor Greenough held “grand discussions of the means of renovating art.” Morse, who was an accomplished Classical painter before he turned to inventing the telegraph, would report to Cooper on the conversations he had with monarchs, prime ministers, and other leading figures—conversations that took place while he painted their portraits.

Cooper’s house was also where the American Polish Committee met each week, with Lafayette rarely absent. The Committee had been formed on July 9, 1831, by Cooper and Lafayette, to collect funds and other aid for the Polish republican revolt, which, by then was a full-scale insurrection against Russian rule. The following are excerpts from Cooper’s letter to the American people on behalf of the Polish Committee. This letter was published in newspapers throughout the United States:

Your countrymen, at Paris, venture to address you in behalf of the ancient (and violated) republic of Poland.... The necessity of order and of defence has given birth to nations.... Next to the tie of blood, that which unites man to his country is the strongest. The sentiment of patriotism is among the purest that adorns human nature—experience has shown it can not be destroyed without bringing with its loss a moral abasement that disqualifies its subjects for all aspiring and noble enterprises.... Conquest falls upon a people like a blight, checking the currents of its generous ambition and withering its fairest hopes.... Such a fate, befalling the smallest community, would be entitled to, and we are certain it would awaken, your pity, but when Poland was overcome the fifth power of Christendom was trodden upon.... The crime of Poland was too much liberty. The independent existence, in the vicinity of those who had reared their thrones on the foundation of arbitrary will was not to be endured.... Against the injustice of her lot and the further accumulation of these manifold

wrongs, the Poles have arisen before God and man. They have proclaimed their sufferings, they have asserted their rights and nobly have they staked all worldly interests on the issue. . . . People of America! Of all the nations of the earth you are the most favored. . . . The self denial and hardships of your ancestors are requited to their descendants in a tenfold return of peace, security, and happiness. To you, then do we apply to contribute from your abundance, to the urgent wants of this wronged nation. . . . Your great example is silently wearing away the foundations of despotism throughout Europe. . . . Be not then unworthy of your trust, by coldly withholding yourselves from the finest charities of your nature, but remember that not a freeman falls, in the most remote quarter of the world, that you do not lose one who is enlisted in your own noble enterprise. . . .

As a result of Cooper's appeal, committees to support Poland were formed in cities throughout the United States. Although the Polish revolt was crushed by September 1831, the work of the Committee went on. In January 1832, Cooper published in American newspapers the letter he received from the leaders of the Polish revolutionaries. One of these was Gen. Karl Kniaziewicz (1762-1842), who was trained by Gen. Thaduis Kosciuszko, a participant in the American Revolution and member of the Society of the Cincinnati.

That same January, Cooper sent Dr. Samuel Grindley Howe to Poland to deliver money and intelligence to the republicans. Howe was arrested, held for one month, and then deported to France. Howe, prior to this assignment, had spent five years in Greece aiding the Greek republicans in their revolt against Turkish and Russian domination. Thirty years later, Howe was the chief medical officer for the Union Army in the Civil War. His wife, Julia Ward Howe, is best known today as the author of the Civil War anthem, "The Battle Hymn of the Republic."

By the Spring of 1832, the republican revolts had been crushed in country after country.

## Return to America

In the Fall of that year, Cooper looked around Europe and saw that the republican movement, which had shown so much promise of success two years earlier, was everywhere repressed by force or guile. As he reflected on the past two years, he regretted once again the fatal compromise Lafayette had made with Louis Philippe. For had Lafayette taken the power offered to him in 1830, the whole of Europe could have been won. There was nothing more for Cooper to do in Europe for the present.

Serious problems were developing in America. The British-directed South Carolina secession movement arose; President Andrew Jackson was destroying the dirigist economic system of the country and refusing to defend American insti-

tutions abroad; and reports from Cooper's U.S.-based allies about the degeneration of American society disturbed him greatly. Arriving in the United States after seven years abroad, he was shocked at the deterioration of the institutions created by his father, Washington, Hamilton, Lafayette, and the others of the first generation of the Society of the Cincinnati.

Cooper went right to work to revive America's knowledge of and commitment to the ideas of 1776. In 1834, he published the book-length *A Letter to His Countrymen*, in which he elaborated on the theme he had begun in *Notions of the Americans*. Americans must break the slavish dependence on foreign (oligarchical) opinion, he said. This problem especially dominated the U.S. newspapers. For example, during 1833, the *New York American* reprinted an attack on *The Bravo* from the Parisian *Journal des Débats*. Cooper responded to this article in a letter to Samuel Morse: "*The Bravo* is certainly no very flattering picture for the upstart aristocrats of the new regimes, and nothing is more natural than their desire to undervalue the book; but the facility betrayed by our own journals, in an affair of this nature, is a source of deep mortification to every American of right feeling. . . ."

By the mid-1830s, Cooper himself became the main target of the treasonous, oligarchy-allied press of the United States. The vicious, vile, and lying campaign against him by the newspapers was a precedent for similar attacks on Lyndon LaRouche today. For example, reviews of his books, by especially British and American newspapers (many of them actually owned by British subjects), were vicious. Typical was a review of his novel *The Monikins*: "It is a mass of husks and garbage, and has disgraced the country," one wrote. A review of a commentary written by Sir Walter Scott's son-in-law, read, "Lockhart showed potent causticity in exposing the gangrene of Cooper's mind in its most foul and diseased state."

Name-calling was not enough; Cooper was lied about, misquoted, and distorted, his views falsified by one journal after another. Cooper counterattacked with a series of libel suits numbering in the dozens. Unlike today, the judgment of the courts in such suits was based on truth. Thus, he won case after case, actually putting several newspapers out of business.

His approach to this battle, which was referred to at the time as "Cooper's War Against the Press," was, in his words: "So far as my means allow, insult shall be avenged by law, violence repelled by a strong hand, falsehood put to shame by truth, and sophistry exposed by reason."

As newspaper after newspaper attacked him, he sued, again and again, and beat them, one after another. He was determined, he said, to "bring the press, again, under the subjection of the law. When one considers the characters, talents, motives, and consistency of those who contrive it, as a body, he is lost in wonder that any community should have so long submitted to a tyranny so low and vulgar. When it is rebuked thoroughly, it may again become useful." Cooper's comments

on the nature of the press and reporters are as applicable to-day, as they were in his time:

As the press of this country now exists, it would seem to be expressly devised by the great agent of mischief, to depress and destroy all that is good, and to elevate and advance all that is evil in the nation....

Newspapermen are the funguses of letters who flourish on the dunghill of the common mind....

The press is equally capable of being made the instrument of elevating man to the highest point of which his faculties admit, or of depressing him to the lowest....

### The American Democrat

*The American Democrat*, written in 1838, was one of Cooper's contributions to keeping alive the principles of the republic. This little book was designed to be used as a textbook in schoolrooms throughout the country. In this foray into non-fiction, unfortunately, Cooper lost the excitement and punch that had characterized his fiction. Regardless, it is full of gems like the following:

One may certainly be purse-proud, and of all the sources of human pride, mere wealth is the basest and most vulgar minded.... A people that deems the possession of riches its highest source of distinction, admits one of the most degrading of all influences to pre- side over its opinions. At no time, should money be ever ranked as more than a means, and he who lives as if the acquisition of property were the sole end of his existence, betrays the dominion of the most sordid, base, and groveling motive, that offers. Property is desirable as the ground work of moral independence, as a means of improving the faculties, and of doing good to others, and as the agent in all that distinguishes the civilized man from the savage.

Cooper was a religious man, and, as one of the founders of the American Bible Society in 1816, helped to set in motion the missionary work that sent to peoples all over the world the best that America had to offer. Among the missionaries sponsored by the American Bible Society were those who went to Hawaii, and, later, became a decisive influence on Dr. Sun Yat-sen, the father of the Republic of China in 1911.

In 1839, Cooper published a masterful, two-volume *History of the United States Navy*, that is still, today, a standard reference for its early history. He had spent four years in the Navy in his youth, and maintained an active attachment to that institution throughout his life. On at least two occasions, U.S. Presidents considered him for appointment as Secretary of the Navy.

His comments in this book on the necessity of military preparedness are as applicable today as they were when they



Library of Congress

*Samuel F.B. Morse (shown in a photo by Mathew Brady), best known for inventing the telegraph, was an accomplished Classical painter, and a member of the Cincinnati; he reported to Cooper on the conversations he had with numerous leading figures, whose portraits he painted.*

were written. Cooper demonstrated that the reluctance to assert the potential power of the country to build a navy that would make the U.S. a world power, was the reason the European powers were able to intimidate the nation. He said that the nation had never built what it needed in time of peace to protect our trade, seamen, and ports; and never allocated enough in time of war.

Two of his later novels, *The Crater* and *The Mercedes of Castile*, are beautiful demonstrations of how an author, committed to uplifting and educating his readers, is able to communicate important scientific concepts and ideas in the context of exciting adventure stories. *The Mercedes of Castile* is the story of Christopher Columbus. *The Crater*, a Robinson Crusoe-type of adventure, is one of the best antidotes to the environmentalist lie that mankind is a pest to nature. Not only is the book loaded with ideas and "how to" about astronomy, navigation, volcanoes, the sea, weather, agriculture, and shipbuilding, but the theme itself is one that can guide us in colonizing Mars.

In the book, two men stranded on a desert island transform it by their labor and ingenuity into a lush garden. This tale is a beautiful demonstration of mankind acting on the injunction

of Genesis to “Be fruitful, and multiply, and replenish the earth, and subdue it.”

In all, Cooper wrote more than 40 novels, innumerable essays and letters, and an important handful of non-fiction works.

### Cooper’s Legacy: The Republic Survives

During the 1840s, as the oligarchy of Europe pushed forward its attempt to split the United States between North and South, Cooper and others of the Cincinnati Society network began building a new republican political movement. The millions of German immigrants who had come to America after 1815, became one of the driving elements of this new movement, contributing an infusion of republican spirit and culture, helping to revive the great ideas of 1776. This movement, which was to found the Republican Party of Abraham Lincoln in 1856, used the dying Whig Party in 1852 to run Gen. Winfield Scott for President. Scott was a member of the Society of the Cincinnati, the hero of the War of 1812, and Commander of the U.S. Army for 30 years. During 1850 and 1851, Cooper, Scott, and Cooper’s old friend Commodore William Schucrick planed out Scott’s campaign.

Cooper’s unfortunate death in 1851 put Scott’s campaign in the hands of Cooper’s enemies, ensuring that Scott would lose the election. Yet, Cooper’s work in helping to build the new republican movement in the United States, resulted eight years later in the victory of Abraham Lincoln. Lincoln crushed the oligarchy-run insurrection of the Southern States and launched the American Industrial Revolution, ensuring the survival of the United States as, in the words of Lafayette, “the temple of liberty and beacon of hope for all mankind.”

---

### From *The Bravo*

---

## ‘A Republic, If You Can Keep It’

*There is no question that James Fenimore Cooper took Benjamin Franklin’s words to heart in The Bravo, where, from the opening, he declares war on Sophists, especially those of the “Serenissima Republic,” who falsely claim title to “republic.” The Preface begins: “It is to be regretted the world does not discriminate more justly in its use of political terms. Governments are usually called either monarchies or republics.”*

*In the 1834 Letter to His Countrymen, Cooper is specific: “aristocracy” and “oligarchists” are the enemy of the American System. He writes “with the painful convic-*

*tion that many of my own countrymen were influenced by the fallacy that nations could be governed by an irresponsible minority, without involving a train of nearly intolerable abuses, I determined to attempt a series of tales, in which American opinion should be brought to bear on European facts. With this design The Bravo was written, Venice being its scene, and her polity its subject.” Nearly midway through, Cooper interrupts the gripping tale to directly address the reader. Here are his words.*

—Michele Steinberg

“Venice, though ambitious and tenacious of the name of a republic, was, in truth, a narrow, a vulgar, and an exceedingly heartless oligarchy. To the former title she had no other claim than her denial of the naked principle already mentioned, while her practice is liable to the reproach of the two latter, in the unmanly and narrow character of its exclusion, in every act of her foreign policy, and in every measure of her internal police. . . . At the period of which we write, Italy had several of these self-styled commonwealths, in not one of which, however, was there ever a fair and just confiding of power to the body of the people, though perhaps there is not one that has not been cited sooner or later in proof of the inability of man to govern himself! In order to demonstrate the fallacy of a reasoning which is so fond of predicting the downfall of our own liberal system, supported by examples drawn from transatlantic states of the middle ages, it is necessary only to recount here a little in detail the forms in which power was obtained and exercised in the most important of them all.

“Distinctions in rank, as separated entirely from the will of the nation, formed the basis of Venetian polity. Authority, though divided, was not less a birthright than in those governments in which it was openly avowed to be a dispensation of Providence. The patrician order had its high and exclusive privileges, which were guarded and maintained with a most selfish and engrossing spirit. He who was not born to govern, had little hope of ever entering into the possession of his natural rights: while he who was, by the intervention of chance, might wield a power of the most fearful and despotic character. At a certain age all of senatorial rank (for, by a specious fallacy, nobility did not take its usual appellations) were admitted into the councils of the nation. The names of the leading families were inscribed in a register, which was well entitled the ‘Golden Book,’ and he who enjoyed the envied distinction of having an ancestor thus enrolled could, with a few exceptions . . . present himself in the senate and lay claim to the honors of the “Horned Bonnet.” Neither our limits nor our object will permit a digression of sufficient length to point out the whole of the leading features of a system so vicious, and which was, perhaps, only rendered tolerable to those it governed by the extraneous contributions of captured and subsidiary provinces, of which in truth, as in all cases of metropolitan rule, the op-

pression weighed most grievously. The reader will at once see that the very reason why the despotism of the self-styled Republic was tolerable to its own citizens was but another cause of its eventual destruction.

“As the senate became too numerous to conduct with sufficient secrecy and dispatch the affairs of a state that pursued a policy alike tortuous and complicated, the most general of its important interests were intrusted to a council composed of three hundred of its members. In order to avoid the publicity and delay of a body large even as this, a second selection was made, which was known as the Council of Ten, and to which much of the executive power that aristocratical jealousy withheld from the titular chief of the state, was confided. To this point the political economy of the Venetian Republic, however faulty, had at least some merit for simplicity and frankness. The ostensible agents of the administration were known, and though all real responsibility to the nation was lost in the superior influence and narrow policy of the patricians, the rulers could not entirely escape from the odium that public opinion might attach to their unjust or illegal proceedings. But a state whose prosperity was chiefly founded on the contribution and support of dependants, and whose existence was equally menaced by its own false principles, and by the growth of other and neighboring powers, had need of a still more efficient body in the absence of that executive which its own Republican pretensions denied to Venice. A political inquisition, which came in time to be one of the most fearful engines of police ever known, was the consequence. An authority as irresponsible as it was absolute, was periodically confided to another and still smaller body, which met and exercised its despotic and secret functions under the name of the Council of Three. The choice of these temporary rulers was decided by lot, and in a manner that prevented the result from being known to any but to their own number and to a few of the most confidential of the more permanent officers of the government. Thus there existed at all times in the heart of Venice a mysterious and despotic power that was wielded by men who moved in society unknown, and apparently surrounded by all the ordinary charities of life; but which, in truth, was influenced by a set of political maxims that were perhaps as ruthless, as tyrannic, and as selfish, as ever were invented by the evil ingenuity of man. It was, in short, a power that could only be intrusted, without abuse, to infallible virtue and infinite intelligence, using the terms in a sense limited by human means; and yet it was here confided to men whose title was founded on the double accident of birth, and the colors of balls, and by whom it was wielded without even the check of publicity.

“The Council of Three met in secret, ordinarily issued its decrees without communicating with any other body, and had them enforced with a fearfulness of mystery, and a suddenness of execution, that resembled the blows of fate. The Doge himself was not superior to its authority, nor protected from its decisions, while it has been known



*The “Mouth of the Lion” graced the door to the Sala dei Tre Capi—the Council of the Three, of the Palazzo Ducale in Venice. It invites, “secret denunciations against those who conceal gifts and advantages or conspire to hide their true profit,” by dropping the secret “evidence” into its mouth.*

that one of the privileged three has been denounced by his companions. There is still in existence a long list of the state maxims which this secret tribunal recognised as its rule of conduct, and it is not saying too much to affirm, that they set at defiance every other consideration but expediency, all the recognised laws of God, and every principle of justice, which is esteemed among men. The advances of the human intellect, supported by the means of publicity, may temper the exercise of a similar irresponsible power, in our own age; but in no country has this substitution of a soulless corporation for an elective representation, been made, in which a system of rule has not been established, that sets at naught the laws of natural justice and the rights of the citizen. Any pretension to the contrary, by placing profession in opposition to practice, is only adding hypocrisy to usurpation.

“It appears to be an unavoidable general consequence that abuses should follow, when power is exercised by a permanent and irresponsible body, from whom there is no appeal. When this power is secretly exercised, the abuses become still more grave. It is also worthy of remark, that in the nations which submit, or have submitted, to these undue and dangerous influences, the pretensions to justice and generosity are of the most exaggerated character; for while the fearless democrat vents his personal complaints aloud, and the voice of the subject of professed despotism is smothered entirely, necessity itself dictates to the oligarchist the policy of seemliness, as one of the conditions of his own safety.”



# *The Sex Life of Goldman Sachs*

On Oct. 13, as the incredible news of the proposed \$100 billion bank-bailout fund called the Master Liquidity Enhancement Conduit (MLEC) was hitting the news wires, economist Lyndon LaRouche issued the following statement:

“To understand the present state of the world’s financial system, think of Goldman Sachs as the financial equivalent of a male praying mantis, whose head is being eaten by its female partner during the male’s merry act of copulation.

“The relevant action between the mating pairs on this occasion, is not sexual, but financial, called ‘uttering.’ The female partner already engaged in consuming the head of its male partners, such as the Goldman Sachs group, is British, presently disguised as the Bank of England.

“The underlying principle is the same used by the Anglo-Dutch Liberal banking system’s creation of the Reichsmark bubble which blew up in late 1923. Then, the act of uttering was performed through the hyperinflationary emission of currency-notes by the Weimar Reichsbank. Today, the emission of the utterings occurs chiefly through the issue of fraudulent financial assets through hedge-fund and related operations.

“Pedagogical, adults-only showings of the relevant pairings of male and female mantises should be presented to all associates of the Goldman Sachs group, and similar suckers, so that they might have a fair idea of the actually intended acme of their currently ongoing financial acts.”

LaRouche conveyed the fact that the proposed bailout, which plan had been put together by that bunch of current and former executives from the Goldman Sachs investment house, including Treasury Secretary Henry Paulson, who are ensconced in virtually every leading banking position in the world today, is a piece of suicidal stupidity. The scheme is effectively a “death by living will” statement which orders the self-inflicted, early, hyperinflationary destruction of the dollar and the U.S. economy in favor of the British Empire.

What is causing the bankruptcy of the dollar-based world financial system currently, is the massive explo-

sion of hedge fund and other gambling debts, debts essentially contracted by the British Empire’s own offshore havens such as the Cayman Islands. Just as the Versailles powers demanded that Germany pay exorbitant war reparations after World War I, thus forcing the Germans into adopting hyperinflationary measures that led to the 1923 crash, so the Queen’s Caymans are demanding that the Federal Reserve go on a money-printing binge to allow the banks to pay their debts.

But the debt, which amounts to *trillions*, not billions of dollars, *cannot* be paid. The only place such a hyperinflationary path leads is to an explosive collapse. Meanwhile, of course, the predatory private financial interests, like Her Majesty’s Cayman Islands-based hedge funds, are moving in, the way the victorious powers in World War I did, to take over whatever physical assets they can get, so that they can maintain control once the crash has occurred.

Most of the world’s bankers, of course, are clear that the Goldman Sachs plan is not going to work, to salvage the trillions of dollars of worthless paper which the hedge funds are trying to unload. But, faced with the results of their disastrous conduct over the last 40 years, the bankers see no alternative to suicide.

There is one solution on the table, but it’s one they don’t want to accept. That is the proposal put forward by LaRouche for a bankruptcy reorganization of the entire world financial system. LaRouche has been advocating this reorganization for decades, pressing world governments to act in their own interest against the globalized financial powers that have been sucking the life-blood out of the world economy. Every delay in accepting his proposal has caused measureless more suffering.

Now the climax has arrived. The global financial succubus, whose primary home is the City of London, is poised to move in for the destruction of the only institution which could challenge its power effectively, the constitutional government of the United States. It’s a question of survival and patriotism: Either embrace LaRouche’s plan to protect the U.S. banks and population—or be condemned as nothing but a British traitor to your country, and the human race.

# 21<sup>st</sup> CENTURY is now electronic!

## SCIENCE & TECHNOLOGY

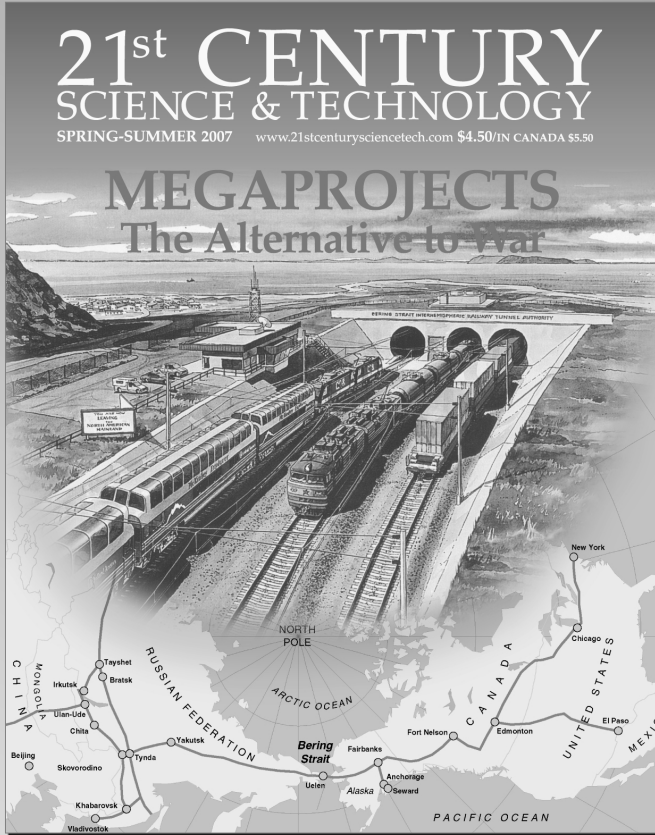

## 21<sup>ST</sup> CENTURY SCIENCE & TECHNOLOGY

Subscriptions are 6 issues \$25 or 12 issues \$48.

Purchase with credit card online at

[www.21stcenturysciencetech.com](http://www.21stcenturysciencetech.com)

Or send a check or money order to the address below.  
Electronic subscriptions to **21st Century** can be purchased at

<http://www.21stcenturysciencetech.com>, \$25 for 6 issues, or \$48 for 12 issues. Single issues are \$5 each.

**21st Century** P.O. Box 16285  
Washington, D.C. 20041  
Tel. 703-777-6943, Fax 703-771-9214

Spring-Summer 2007

FEATURING:

### CO<sub>2</sub>: The Greatest Scientific Scandal of Our Time

by Zbigniew Jaworowski, M.D., Ph.D., D.Sc.

A senior multidisciplinary scientist reviews the political agenda of the Intergovernmental Panel on Climate Change and documents the fraud of its global warming science.

### ▪ Mankind Is Going Back To the Moon!

by Marsha Freeman

China, Russia, India, Japan, and newer spacefaring nations are planning multigenerational great projects to go to the Moon and beyond. Will the United States join them?

### ▪ Bering Strait Tunnel Back on World Agenda!

by Rachel Douglas

The megaproject to link Eurasia and America, as part of the World Land-Bridge, was propelled to center stage by an international conference in Moscow.

OTHER ARTICLES INCLUDE:

#### ▪ The Road to Hell Is Paved Green

by Leandra Bernstein, LaRouche Youth Movement

#### ▪ The Ampère Angular Force and The Newton Hoax

by Laurence Hecht

#### ▪ Low-dose Irradiation Therapy Cures Gas Gangrene Infections

by Jerry M. Cuttler

#### ▪ IT'S STILL MOONSHINE

##### —Smell of Gigantic Hoax in Government Ethanol Promotion

by Laurence Hecht

#### ▪ —Biofuels Are a Policy of Famine

by Marcia Merry Baker

#### ▪ Resurgent Tuberculosis: Deadly Disease of Globalization

by Christine Craig

# See LaRouche on Cable TV

\* Call station for times.

## INTERNET

LAROCHEPUB.COM Click  
LaRouche Writings (Available 24/7)  
SCANTV.ORG Click Scan on the Web  
Sat: 2 pm (Pacific Time only)  
• WUWF.ORG Click *Watch WUWF-TV*  
Last Mon: 4:30-5 pm (Eastern Time only)

## ALABAMA

• BIRMINGHAM Ch.4 Wed: 11-11:30 pm  
• UNIONTOWN Ch.2 Mon-Fri: every 4 hrs.; Sun: Afternoons

## ALASKA

• ANCHORAGE Ch.9 Thu: 10 pm

## CALIFORNIA

• BEVERLY HILLS T/W Ch.43 Wed: 4 pm  
• CLAY/CONCORD Comcast Ch.26  
2nd Tue: 7 pm; Astound Ch.31 Tue: 7:30 pm  
• CONTRA COSTA Comcast Ch.26  
2nd Tue: 7 pm  
• COSTA MESA TimeWarner Ch.35;  
Thu: 5:30 pm  
• E.LOS ANGELES T/W Ch.98 Mon: 2 pm  
• HOLLYWOOD T/W Ch.24 Tue: 4:30-5 pm  
• LANCASTER • PALMDALE T/W  
Ch.36 Sun: 1 pm  
• LONG BEACH Analog Ch.65/69;  
Digital Ch.95; 4th Tue: 1-1:30 pm  
• LOS ANGELES T/W Ch. 98 Wed: 3-3:30 pm  
• MARINA DEL REY T/W Ch.98 Wed:  
3-3:30 pm; T/W Ch.24; Thu & Fri: 4 pm  
• MIDWILSHIRE T/W Ch.24 Tue: 4:30-5 pm  
• NE SAN FDO. VLY. Comcast Ch.20  
Wed: 4 pm  
• N.ORANGE COUNTY T/W  
Ch.95/97/98 Fri: 4-4:30 pm  
• SANTA MONICA T/W Ch.77 Wed: 3-3:30 pm  
• WALNUT CREEK Comcast Ch.6 2nd  
Tue: 7 pm; Astound Ch.31 Tue: 7:30 pm  
• VAN NUYS TimeWarner Ch.25 Sun:  
5:30 pm  
• W. SAN FDO. VLY. TimeWarner  
Ch.34 Wed: 5:30 pm

## CONNECTICUT

• GROTON--Ch.12 Mon: 5 pm  
• NEW HAVEN Ch.23 Sat: 6 pm

## DISTRICT

• WASHINGTON Comcast Ch.95; RCN  
Ch.10 Irregular Days/Times

## FLORIDA

• ESCAMBIA Cox Ch.4 Last Sat: 4:30 pm

## ILLINOIS

• CHICAGO Ch.21  
Comcast/RCN/WOW\*  
• PEORIA COUNTY Insight Ch.22 Sun:  
7:30 pm  
• QUAD CITIES Mediacom Ch.19 Thu:  
11 pm

## IOWA

• QUAD CITIES Mediacom Ch.19 Thu:  
11 pm

## KENTUCKY

• BOONE/KENTON Insight Ch.21 Sun:  
1 am; Fri: Midnight  
• JEFFERSON Insight Ch.98 Fri: 2-2:30 pm

## LOUISIANA

• ORLEANS PARISH Cox Ch.78 Tue: 4 am & 4 pm

## MAINE

• PORTLAND TimeWarner Ch.2 Mon:  
1&11 am,5 pm

## MARYLAND

• ANNE ARUNDEL Annapolis Ch.76  
Milleneum Ch.99; Sat: 12:30 am;  
Sun: 12:30 am; Tue: 6:30 pm  
• P.G.COUNTY Comcast Ch.76  
Tue/Thu: 11:30 am

## MASSACHUSETTS

• BRAINTREE Comcast Ch.31; BELD  
Ch.16 Tue: 8 pm  
• CAMBRIDGE Comcast Ch. 10 Tue:  
2:30 pm; Fri: 10:30 am  
• WALPOLE Comcast Ch.8 Tue: 1-1:30 pm

## MICHIGAN

• BYRON CENTER Comcast Ch.25  
Mon: 2 & 7 pm  
• DETROIT Comcast Ch.68  
Unscheduled pop-ins  
• KALAMAZOO Charter Ch. 20 Thu: 11 am;  
Sat: 10 am  
• KENT COUNTY Comcast Ch.25 Fri:  
1:30 pm  
• N.KENT COUNTY Charter Ch.22  
Wed: 3:30 & 11 pm  
• LAKE ORION Comcast Ch.10  
Mon/Tue: 2 & 9 pm  
• LIVONIA Bighthouse Ch.12 Thu: 3 pm  
• MT.PLEASANT Charter Ch. 3 Tue:  
5:30 pm; Wed: 7 am  
• PORTAGE Charter Ch.20 Tue/Wed:  
8:30 am; Thu: 1:30 pm  
• SHELBY TWP. Comcast Ch.20 WOW  
Ch.18; Mon/Wed: 6:30 pm  
• WAYNE COUNTY Comcast Ch.16/18  
Mon: 6-8 pm  
• WYOMING Comcast Ch 25 Wed:  
9:30 am

## MINNESOTA

• BURNSVILLE • EGAN Comcast  
Ch.14 Sun, Tue, Thur, Sat: 4:30 pm;  
Mon, Wed, Fri.: 4:30 am  
• CAMBRIDGE US Cable Ch.10 Wed:  
6 pm  
• COLD SPRING US Cable Ch.10  
Wed: 6 pm  
• COLUMBIA HTS. Comcast Ch.15  
Wed: 8 pm  
• DULUTH Charter Ch.20 Mon: 9 pm;  
Wed: 12 pm; Fri: 1 pm  
• MINNEAPOLIS TimeWarner Ch.16  
Tue: 11 pm  
• MINNEAPOLIS (Northern Burbs)  
Comcast Ch.15 Thu: 3 & 9 pm  
• NEW ULM Ch.14 Fri: 5 pm  
• PROCTOR Ch.12 Tue: 5 pm to 1 am  
• ST.CLOUD AREA Charter Ch.12  
Mon: 9:30 pm

• ST.CROIX VLY. Comcast Ch.14 Thu:  
1 & 7 pm; Fridays--9 am  
• ST.LOUIS PARK Comcast Ch.15  
Sat/Sun/Mon/Tue Midnite, 8 am, 4 pm  
• St.PAUL (S&W suburbs) Comcast  
Ch.15 Wed: 10:30 am; Fri: 7:30 pm  
• S.WASHINGTON Comcast Ch.14  
Thu: 8 pm

## MISSOURI

• ST.LOUIS Charter Ch.22 Wed: 5 pm;  
Thu: 12 Noon

## NEVADA

• WASHOE CTY Charter Ch.16 Thu: 2 pm

## NEW HAMPSHIRE

• MANCHESTER Comcast Ch.23 Thu:  
4:30 pm

## NEW JERSEY

• HADDEN TWP Comcast Ch.19 Sun:  
10 am  
• MERCER CTY Comcast\*  
• TRENTON Ch.26 3,4 Fri: 6-6:30 pm  
• WINDSORS Ch.27 Mon: 5:30-6 pm  
• MONTVALE/MAHWAH Cablevision  
Ch.76 Mon: 5 pm  
• PISCATAWAY Cablevision Ch.22  
Thu: 11:30 pm  
• UNION Comcast Ch.26 Unshed.  
Fillers

## NEW MEXICO

• ALBUQUERQUE Comcast Ch.27  
Thu: 4 pm  
• LOS ALAMOS Comcast Ch.8 Wed:  
10 pm  
• SANTA FE Comcast--Ch.8 Thu: 9 pm  
Sat: 6:30 pm  
• SILVER CITY{Conley Productions}  
Daily: 8-10 pm  
• TAOS Ch.2 Thu: 7 pm

## NEW YORK

• ALBANY T/W Ch.18 Wed: 5 pm  
• BETHLEHEM TimeWarner Ch.18  
Thu: 9:30 pm  
• BRONX Cablevision Ch.70 Wed: 7:30 am  
• BROOKLYN T/W Ch.35; Cablevision  
Ch.68 Mon: 10 am  
• CHEMUNG T/W Ch.1/99 Tue: 7:30 pm  
• ERIE COUNTY Adelphia Ch.20 Thu  
10:35 pm  
• IRONDEQUOIT T/W Ch.15; Mon/Thu:  
7 pm  
• JEFFERSON • LEWIS T/W Ch.99  
Unscheduled pop-ins  
• NIAGARA/ERIE T/W Ch.20 Thu:  
10:35 pm  
• ONEIDA T/W Ch.99 Thu: 8 or 9 pm  
• PENFIELD Ch.15 Penfield Comm.  
TV\*  
• QUEENS T/W Ch.35; Tue: 10:30 am  
• QUEENSBURY T/W Ch.71; Mon: 7 pm  
• ROCHESTER T/W Ch.15, Sun:9 pm;  
Thu:8 pm  
• ROCKLAND Cablevision Ch.76 Mon:  
5 pm  
• SCHENECTADY T/W Ch.16; Fri: 1 p.m.  
Sat: 1:30 am  
• STATEN ISL. TimeWarner Thu:  
Midnite (Ch.35); Sat: 8 am (Ch.34)  
• TOMKINS CTY Sun: 12:30 pm; Sat: 6 pm

• TRI-LAKES Adelphia Ch.2 Sun:7 am,  
1 pm, 8 pm  
• WEBSTER Ch.12 Wed: 9 pm

## NORTH CAROLINA

• HICKORY Charter Ch.3 Tue: 10 pm

## OHIO

• AMHERST T/W Ch.95 Daily 12 Noon & 10 pm  
• CUYAHOGA T/W Ch.21 Wed: 3:30 pm  
• OBERLIN Cable Co-Op Ch.9 The: 8 pm

## OKLAHOMA

• NORMAN Cox Ch.20 Wed: 9 pm

## OREGON

• LINN/BENTON Comcast Ch.29 Tue:  
1 pm; Thu: 9 pm  
• PORTLAND Tue:6 pm (Ch.22); Thu:3 pm (Ch.23)

## RHODE ISLAND

• E.PROVIDENCE Cox Ch.18 Tue:  
6:30 pm  
• STATEWIDE RI Interconnect Cox  
Ch.13  
Tue:10-10:30 am

## TEXAS

• DALLAS Comcast Ch.13-B Tue:  
10:30 pm  
• HOUSTON T/W Ch.17 TV Max  
Ch.95; Wed: 5:30 pm; Sat: 9 am  
• KINGWOOD Cebridge Ch.98 Wed:  
5:30 pm; Sat: 9 am

## VERMONT

• GREATER FALLS Adelphia Ch.10  
Mon,Wed,Fri: 1 pm  
• MONTPELIER Adelphia Ch.15 Tue: 9 pm;  
Wed: 3 pm

## VIRGINIA

• ALBERMARLE Comcast Ch.13 Sun:  
4 am; Fri: 3 pm  
• ARLINGTON Comcast Ch.33 Mon: 1 pm;  
Tue: 9 am  
• CHESTERFIELD Comcast Ch.6 Tue:  
5 pm  
• FAIRFAX Ch.10 1st & 2nd Wed: 1 pm  
• LOUDOUN Comcast Ch.23 Wed: 6 pm  
• ROANOKE Ch.78 Tue: 7 pm; Thu: 2 pm

## WASHINGTON

• KING COUNTY Comcast Ch.29/77  
Sat: 2 pm  
• TRI CITIES Charter Ch.13/99 Mon: 7 pm  
Thu: 9 pm  
• WENATCHEE Charter Ch.98 Thu: 1 pm

## WISCONSIN

• MARATHON Charter Ch.10 Thu: 9:30 pm;  
Fri: 12 noon  
• MUSKEGO TimeWarner Ch.14 Sat: 4 pm;  
Sun: 7 am

## WYOMING

• GILLETTE Bresnan Ch.31 Tue: 7 pm

If you would like to get The **LaRouche Connection** on your local cable TV system, please call Charles Notley at 703-777-9451, Ext. 322. For more information, visit our Website at <http://www.larouche.pub.com/tv>

SUBSCRIBE TO

# EIR Executive Intelligence Review

## EIR Online

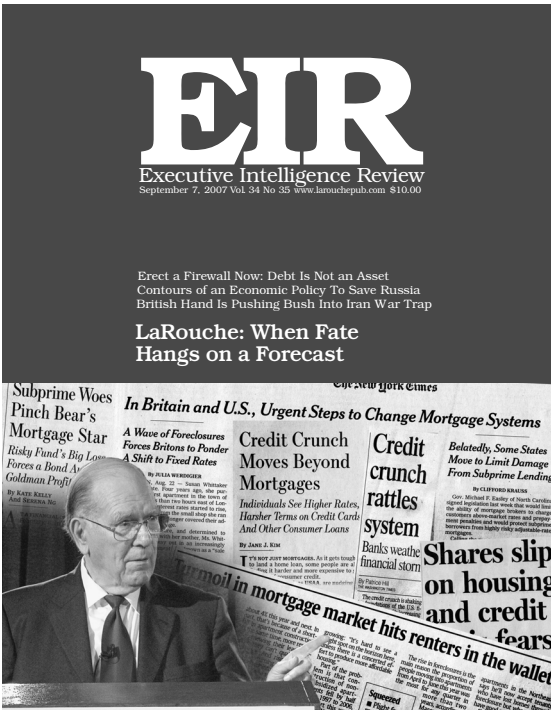

**EIR Online** gives subscribers one of the most valuable publications for policymakers—the weekly journal that has established Lyndon LaRouche as the most authoritative economic forecaster in the world today. Through this publication and the sharp interventions of the LaRouche Youth Movement, we are changing politics in Washington, day by day.

## EIR Online

Issued every Tuesday, EIR Online includes the entire magazine in PDF form, plus up-to-the-minute world news.



I would like to subscribe to **EIR Online**

(e-mail address must be provided.)

- \$360 for one year
  - \$180 for six months
  - \$120 for four months
  - \$90 for three months
  - \$60 for two months
- Send information on receiving **EIR** by mail.

—EIR Online can be reached at:

**www.larouchepub.com/eiw**

e-mail: **fulfillment@larouchepub.com**

Call **1-800-278-3135** (toll-free)

Name \_\_\_\_\_

Company \_\_\_\_\_

Address \_\_\_\_\_

City \_\_\_\_\_ State \_\_\_\_\_ Zip \_\_\_\_\_ Country \_\_\_\_\_

Phone (\_\_\_\_\_) \_\_\_\_\_

E-mail address \_\_\_\_\_

I enclose \$ \_\_\_\_\_ check or money order

Make checks payable to  
**EIR News Service Inc.**  
 P.O. Box 17390, Washington, D.C. 20041-0390

Please charge my  MasterCard  Visa

Card Number \_\_\_\_\_

Signature \_\_\_\_\_

Expiration Date \_\_\_\_\_