

EIR

Executive Intelligence Review

November 2, 2012 Vol. 39 No. 43 www.larouche.com \$10.00

LaRouche: Dump the Parties; Put Recovery Program in Now
Is Mankind Smarter Than the Dinosaurs?
Down to the Wire To Restore Glass-Steagall Principle

**Man's Crucial, Future Role in Space:
The End for Dummies**



Founder and Contributing Editor:

Lyndon H. LaRouche, Jr.

Editorial Board: *Lyndon H. LaRouche, Jr.,
Antony Papert, Gerald Rose, Dennis Small,
Nancy Spannaus, Jeffrey Steinberg, William
Wertz*

Editor: *Nancy Spannaus*

Managing Editors: *Bonnie James, Susan Welsh*

Technology Editor: *Marsha Freeman*

Book Editor: *Katherine Notley*

Graphics Editor: *Alan Yue*

Photo Editor: *Stuart Lewis*

Circulation Manager: *Stanley Ezrol*

INTELLIGENCE DIRECTORS

Counterintelligence: *Jeffrey Steinberg, Michele
Steinberg*

Economics: *John Hoefle, Marcia Merry Baker,
Paul Gallagher*

History: *Anton Chaitkin*

Ibero-America: *Dennis Small*

Law: *Edward Spannaus*

Russia and Eastern Europe: *Rachel Douglas*

United States: *Debra Freeman*

INTERNATIONAL BUREAUS

Bogotá: *Javier Almarío*

Berlin: *Rainer Apel*

Copenhagen: *Tom Gillesberg*

Houston: *Harley Schlanger*

Lima: *Sara Madueño*

Melbourne: *Robert Barwick*

Mexico City: *Gerardo Castilleja Chávez*

New Delhi: *Ramtanu Maitra*

Paris: *Christine Bierre*

Stockholm: *Ulf Sandmark*

United Nations, N.Y.C.: *Leni Rubinstein*

Washington, D.C.: *William Jones*

Wiesbaden: *Göran Haglund*

ON THE WEB

e-mail: eirns@larouchepub.com

www.larouchepub.com

www.executiveintelligencereview.com

www.larouchepub.com/eiw

Webmaster: *John Sigerson*

Assistant Webmaster: *George Hollis*

Editor, Arabic-language edition: *Hussein Askary*

EIR (ISSN 0273-6314) is published weekly

(50 issues), by EIR News Service, Inc.,

P.O. Box 17390, Washington, D.C. 20041-0390.

(703) 777-9451

European Headquarters: E.I.R. GmbH, Postfach

Bahnstrasse 9a, D-65205, Wiesbaden, Germany

Tel: 49-611-73650

Homepage: <http://www.eirna.com>

e-mail: eirna@eirna.com

Director: Georg Neudecker

Montreal, Canada: 514-461-1557

Denmark: EIR - Danmark, Sankt Knuds Vej 11,

basement left, DK-1903 Frederiksberg, Denmark.

Tel.: +45 35 43 60 40, Fax: +45 35 43 87 57. e-mail:

eirdk@hotmail.com.

Mexico City: EIR, Ave Morelos #60-A, Col Barrio

de San Andres, Del. Azcapotzalco, CP 02240,

Mexico, DF. Tel: 5318-2301, 1163-9734, 1163-9735.

Copyright: ©2012 EIR News Service. All rights reserved. Reproduction in whole or in part without permission strictly prohibited.

Canada Post Publication Sales Agreement

#40683579

Postmaster: Send all address changes to EIR, P.O. Box 17390, Washington, D.C. 20041-0390.

EIR

From the Managing Editor

This week will be decisive for the nation, as we go into the final days before the Nov. 6 Presidential election. The fact that we have just been through one of the worst storms in our history, which has crippled New York City, and left 8 million people without power, brings to mind the Erinyes, who must have concluded that only a shakeup of Olympian proportions could possibly derail the horror that one of the two Presidential candidates will be elected. As Lyndon LaRouche writes in our *Feature* this week: “While Obama is an immediate threat to the very continued existence of the United States . . . Romney has failed to grasp publicly the crucial set of points which are now of the utmost urgency for our republic’s survival. . . .”

Continuing this theme, Helga Zepp-LaRouche, in *International*, asks, “Is Mankind Smarter than the Dinosaurs?”: “The world is . . . already in the midst of a dynamic that could very quickly lead to global thermonuclear war and the extinction of the human species.” Yet no one—not in Germany, nor in the U.S.—is talking about it.

In each case, it is as if we were all sleepwalking to Armageddon.

Digging into the historical background to the current plunge into global war, is the discussion from the Oct. 20 LaRouche Show, with *EIR*’s Hussein Askary and Ramtanu Maitra, on “The Two Kingdoms of Terror,” which is summed up by Askary: “the Kingdom of Saudi Arabia and the British Kingdom are actually inseparable; they are one entity.”

In *National*, we review LaRouche’s Oct. 29 webcast, whose theme was “Dump the Parties, Put Recovery Program in Now!” There is also Obama’s “Benghazigate,” and a sobering warning from an unexpected source: Zbigniew Brzezinski.

In *Economics*, find coverage of the life-or-death fight for Glass-Steagall; and an interview with the Irish patriot Thomas Pringle who is leading a fight against the bailouts.

A first-hand report from the International Aeronautical Congress which met in Naples, Italy, in early October, “amidst uncertainty and hope,” rounds out the issue.

This Friday, LaRouche will deliver a double whammy: a press conference in Washington, and the fourth of his “Friday” webcasts. Both will be available at www.larouchepac.com.



Cover This Week

Liftoff of the Mars Science Laboratory carrying the Curiosity Rover to Mars, Nov. 30, 2011.



NASA

4 A Thesis Carrying a Uniquely Original Message: The End for Dummies!

Lyndon H. LaRouche, Jr. writes that “The case of ‘Curiosity,’ when appropriately assessed, should generate the effect of a shocking change, for the sake of which society must now profoundly redefine its outlook respecting almost everything, on Earth, and under the Sun. . . . The necessary effect should be a powerful effect of a happy discovery, a discovery which has been adopted by people who have come, really, to know what constitutes a really important discovery of a sweepingly new quality in viewing the future of our species.

“In the history of the human species, that is the way we should read our experiences. It is the experience which should define for others, both what the members of our species really are, or have merely chosen to be, or, what we might come to discover, later, even much later, that we really have been heretofore.”

International

19 A Nuclear Powderkeg: Is Mankind Smarter Than the Dinosaurs?

By Helga Zepp-LaRouche. The strategic situation is now more dangerous than during the Cold War, the Cuban Missile Crisis, or the medium-range missile crisis: We are on the brink of thermonuclear annihilation of the human species. Yet in Germany, nobody is talking about it.

22 The LaRouche Show: The Two Kingdoms of Terror

EIR specialists Hussein Askary and Ramtanu Maitra are guests on The LaRouche Show, documenting the long history of connivance between the British monarchy and the House of Saud.

32 Wahhabism and Ash'arism

National

33 **LaRouche: Dump the Parties, Put Recovery Program in Now**

With the clock ticking to Election Day, Lyndon LaRouche gave two webcasts, stressing the need to dump Obama and institute a new, non-party political system. Hillary Clinton can play a crucial role, if she chooses to do so.

35 **On Election Eve: Benghazi Lies Blow Up in Obama's Face**

New revelations show that the Administration knew perfectly well that the attack on the U.S. consulate in Libya was a terrorist assault, not a spinoff of some non-existent demonstration. Further, there were U.S. rapid-reaction forces ready to intervene, but they were told to stand down.

37 **Brzezinski: Don't Back Syrian Rebels**

Strong words from Zbigniew Brzezinski, the former anti-Soviet hawk who, as Carter Administration National Security Advisor, helped create the rebel mujahideen in Afghanistan.

Economics

39 **Down to the Wire To Restore the Glass-Steagall Principle**

Although the growing movement for reimposing Glass-Steagall banking regulation has not even been mentioned in the Presidential debates, the restoration of FDR's Glass-Steagall principle is a matter of life-or-death for the American population.

41 **The ESM in the Dock: European Court Hears Pringle's Challenge**

Irish parliamentarian Thomas Pringle challenged the European Union's permanent bailout fund known as the European Stability Mechanism (ESM). The European Court of Justice heard the case that the EU didn't want anyone to hear.

41 **Governments Exist for Citizens, Not Banks**

An interview with Thomas Pringle.

Science

44 **International Astronautical Congress: Space Scientists Meet Amidst Uncertainty and Hope**

The missions that are being carried out today are a testament to the stubborn refusal of space planners to acquiesce to the prospect that there will be no tomorrow. But will they receive the support they need to succeed?

Interviews

41 **Thomas Pringle**

Pringle is an Independent member of the Irish Dáil (parliament), and an opponent of the European Stability Mechanism, the new perpetual bailout for the banks.

Editorial

51 **The Unnatural Disaster**

A THESIS CARRYING A UNIQUELY ORIGINAL MESSAGE:

The End for Dummies!

by Lyndon H. LaRouche, Jr.

October 18, 2012¹

Several Opening Points Urgently To Be Considered:

1. *The estimated ability of mankind to continue to live under the presently reigning, but evolving conditions of our present Sun, is by no means a kind of arrangement designed to endure simply forever. As some academic estimates which had been kicked about among physical-science circuits, have indicated, there is an estimated range of about two billions years, until the Sun “explodes,” or a much earlier doom for human beings still remaining on Earth would occur.*

2. *Nonetheless, if there is no evidence, yet, that the human species itself, even if not also our present Sun, might actually become capable of outliving such kinds of currently “guess-timated” dates, that remains a possible option until shown otherwise.*

On this account, mankind is already known to us as being, intrinsically, unlike any other species known to us as presently existing now, or having existed. Mankind is essentially unlike all other living creatures presently known to us here on Earth; mankind is, for us presently, the only known case of a form of life which has actually voluntarily creative capabilities. The practical challenge to be considered for our references,

1. Here, I return to a topical area which I have touched upon in some depth on earlier occasions. Here, I go into the core of that issue.

here, is: “Should we believe that our species, with its uniquely, categorical noëtic abilities, might, therefore, be capable of continuing to survive indefinitely?”

3. *I present these introductory points on that account from where I am now situated on certain, admittedly on “shaky” evidence, but evidence which is, nonetheless, sound argument. The systemic distinction of the already established “history” of our species, is that of a species which is biologically unique, a species which is presently contrasted, thus, to all others presently known to us.*

This thought is not “wild guesswork” in any sense. Our own species possesses an inherent potential, which lies beyond the limits of the primitive notions of what is called “sense-perception;” we are capable of willfully upward evolution of its already demonstrated potential for action, that with an accessibly unique quality of systemically willful, noëtic characteristics. These noëtic characteristics are both absolutely unlike, and far, far beyond, the achievements of any other species known to exist, or to have existed for us presently.

Yet, we continue to surprise the usual doubters, that while we remain merely mortals, we now remain nonetheless, essentially a living testament to the specific uniqueness, among all other expressions of known life, of what is presently known as mankind. Individual persons are ostensibly mortal, intrinsically, but the noëtic mental capabilities within the bounds of our species, are in that degree, potentially immortal in our consequences.

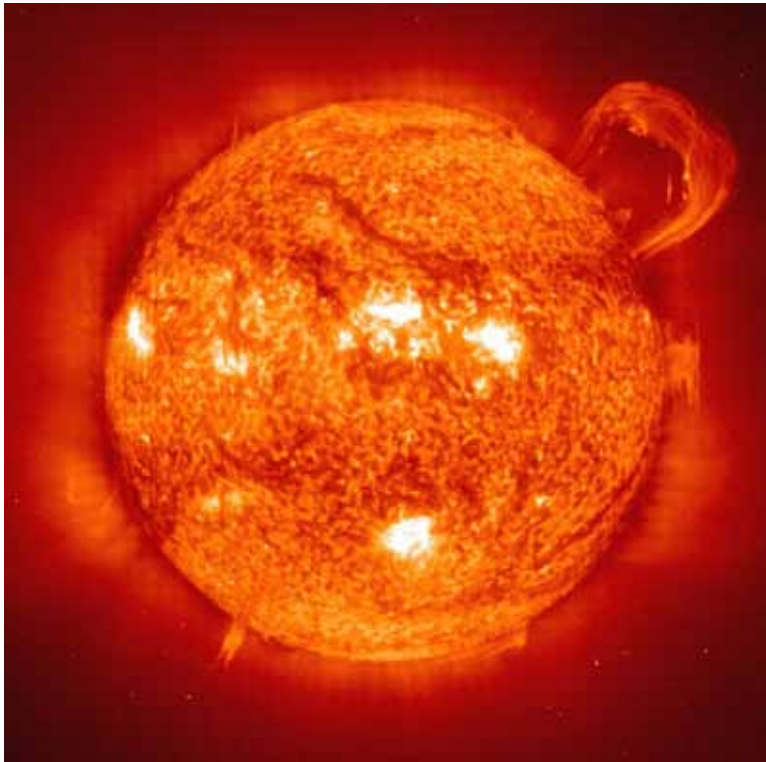

NASA

While the best estimates are that we have approximately 2 billion years until the Sun (shown here, in a coronal mass ejection) “explodes,” it behooves mankind on Earth, as a unique species, to begin to muster our noëtic capabilities to confront and overcome that, and other cosmic challenges.

4. There are several, sequential elements of qualitative-historical evidence, which now point us into the relevant directions for discovering what I am claiming in the course of presenting this report.

First of all: on that account, there is the fact that our human species has already proven its powers to embody a qualitatively innate, and evidently unique potential for mankind.

Second: that potential has been shown to such a foreseeable effect, that what we should choose to believe presently in this matter, must become recognized as the absolutely unique potentials respecting our species’ future existence, potentials which are not known to exist in any other living species presently known to us, other than our own.

5. As I shall indicate in the course of this report, our species has, thus, an inherently unique prospect, for being able to endure as a species, like no other in the known history of this planet’s living species today. The crucial question posed as a challenge to us now, is, “does our species really wish to achieve that kind of immortality in its character, if not of the individual person

as such, but as a species with that species’ immortal potentials for achievements of continuing as a species with our higher qualities of life?”

Therefore: On the subject of this latter question, if and when we take into account, as now, the world’s existing trends in governments, whether that of the U.S. Obama administration, or the oligarchical systems of such as the original Roman empire, or of the present British imperial monarchy, for example, there are some very ugly reasons for what should be any of my continually persisting doubts concerning the actual realization of mankind’s effective potential to bring on its own species’ continued survival beyond that “barrier to continued human life” which is implicitly global, thermonuclear warfare.

It should now be obvious, that these considerations also include the requirement that we become capable of defeating the danger to life from asteroids and comets.

6. Nevertheless, the hope must remain within some among each of us, for the human species’ actions to improve itself in the quality of a potentially immortal species, despite the fact, that each among us, is mortal, and that even despite the opinions of all those mean-spirited varieties of human beings which infest some past and present governments on this planet. That necessary evidence exists which is clear on this point; you, each, have but to discover it.

Therefore, in this conclusion of my opening summary: The evidence for a hopeful conclusion already clearly exists, as the recent “Curiosity” landing affirms this. Such is the discoverable nature, context, and the prospective outcome, of the converging array of subject-matters which I am now bringing for your considerations here.

I. On “Energy-flux Density”

Now, join me in considering, more deeply, that part of the evidence which most readily demonstrates what has been, and is in fact, that which might seem to be the relatively miraculous power of the human species. I emphasize that relatively unusual power which is potentially specific to each newborn from among

our human species: the power to continue the individual's development of those unique qualities needed for the acquisition of ever more powerful means for our unique species to exist, and to gain increased influence within the setting of our living existence.

I restate the point, that this particular, implied intention, the which is embedded in our human species' nature, is apparently unique, a fact which is expressed in those actions taken on behalf of some additionally gained, demonstrably more potent, and universal physical principle. I intend such as the manifest principle which is properly identified as the willfully expressed subsuming "rates of relative increase in our own species' mode of energy-flux density," as by those many varieties of human cultures, which remain now still in a tortured state of intellectual decline which is now, unfortunately, more and more typical of recent trends and generations in the main.

The Matter of "The Green Pest"

For the purposes which I might hope that you and I will share in identifying contrasts, consider the distinction represented by the phenomenon of the prevalently chronic decadence among the increasing ration of contemporary so-called "greenies," in particular.

When that deepening, "green" decadence within contemporary society is examined according to the physical test-principle of "increase of relative energy-flux density," the "greenies" represent, inherently, a decadent variant amid mankind defined more broadly. The "greenie" type is one which has committed itself to persist in dooming itself to ruin, and to becoming eventually extinct, all that amid such obscene and homicidal-suicidal follies as being the product of the influence of the current British Queen's argument. I mean her devotion to what is fairly identified, as large-scale and sweeping measures for promoting of that "green genocide" which is a presently fast-spreading



EIRNS/James Rea

Green "pests," like those shown here at an anti-nuclear demonstration in Berlin, Germany (2010), "represent, inherently, a decadent variant amid mankind defined more broadly."

stench of doom amid the general population of the human species, most notably that within the trans-Atlantic sector.

Continuing the category of relevant plain fact, consider the reductionist scheme of Her Majesty: she claims to represent us by means of her repeatedly stated intent to bring about a currently rapid, and increasingly depraved form of savage reduction of the global population of the human species. Whatever that which you might consider her own specific fancy on this account to be, what Her Majesty has actually done now, presents us with undeniable evidence of her avowed intent to bring upon us all, that scale of relative genocide implicit in her presently publicized, explicitly stated intention. Hers is the present form of a long-traditional, oligarchical cult-doctrine, whose present intention has been to reduce the present world's human population from a currently estimated seven billions persons, to about one billion, or, who might know how much fewer than that is ultimately intended.

The resulting conclusion is, that this must be considered as the kind of evidence which is sufficient to prove the case for Her Majesty's currently incumbent, implicitly genocidal social system's moral unfitnes to



Behind both 9/11-One and 9/11-Two is the British-Saudi imperial impulse—a reincarnation of the Roman Empire, and its offspring, the New Venetian party: The objective is permanent war. Right: the World Trade Center, Sept. 14, 2001; above: the U.S. consulate in Benghazi, Libya, Sept. 11, 2012.

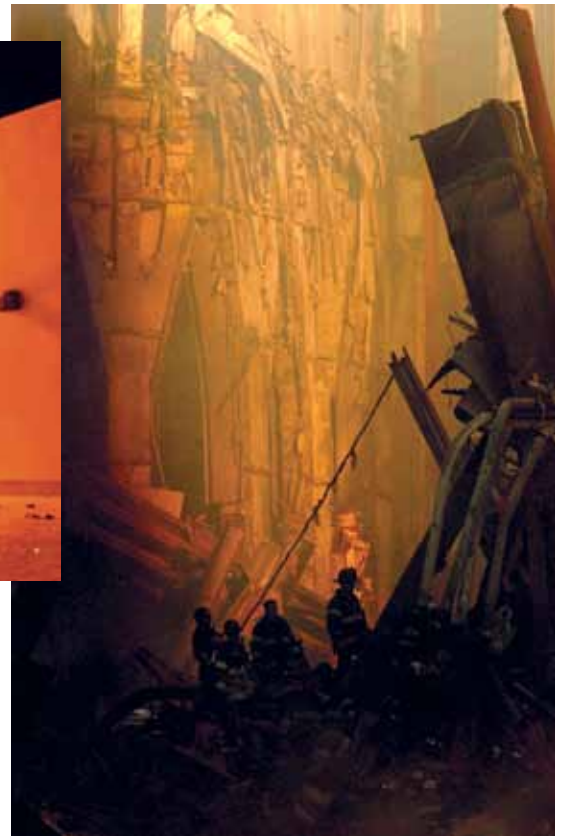

U.S. Navy/Jim Watson

reign among mankind.² Nonetheless, our species itself, considered otherwise, continues to embody a naturally far nobler intention than Her Majesty’s own would now permit. Our argument on behalf of the contrary effect, depends on the condition of the sustaining of a qualitatively endless progress in accordance with the standard result which we should have committed ourselves to bring into play.

To introduce our subject more adequately, consider the following, ironical case in point:

2. That British Queen’s stated motive on this account, is, in the end, nothing more, nor less, than sheer, wicked meanness among those relevant cases of those supporters of her professed cause who are dwelling on our planet today. The demeaning ones of her retinue, and their types, have refused to tolerate any cessation of their continued rule over this planet, which, by its nature, might offend the intentions of that oligarchical tyranny which has oppressed the greatest portion of the human species during the many centuries, even millennia, since some most distantly ancient times. That includes such as the guilt for an exceptionally guilty genocide and for the salting of a formerly inhabited territory, a horror which was reportedly conducted against a defeated Troy. The Roman empire and its legacy are typical of the subsequently recurring threats of a potential self-extinction of the human species, which has been a still recurrent contemporary focus of particular defense of the legacy of that oligarchical system still currently based in the Mediterranean and beyond. The pertains, especially now, to the conditions under the reign of the current British system of imperial outreach.

A Slice from Recent History

Shall we now say “Back then”?

During one among my past political visits into more or less prominent British circles, I was invited to meet with a person of a certain relatively significant official rank, in what had begun as a mutually most courteous tea-session. It ended differently, in that moment when I was informed by a suddenly-turned-irate British hostess, that her particular British political interest was solidly committed to British alliance with that particular sort of British preferred asset, then known as the same François Mitterrand, the one whom I had happened to have justly deplored in our discussion, and whom I had continued to deplore, in effect, over the course of not only that immediate moment, but as a continuing view among her political circles for the following, disastrous years to come.³

The most notable outcome of that, brief, if modestly memorable encounter in London, would be brought to

3. I shall return to the implications of that particular subject, in a suitable place, below here.

the surface a virtual decade later, which would occur in Mitterrand's using the occasion of the sudden fall of the Soviet system, to impose the tyranny of his own French administration to effect a virtual rape of the sovereignties of both Germany's Chancellor Helmut Kohl's and of other continental European governments, and to throw them into a hyperinflation which has been continued to accelerate and to loot the so-called "Euro zone" through the time of the most recent report.

The result of that, has been, in turn, a development which had come like a remorseless movement of the Earth's surface, quickly to comprise what has now become the present day's quality of the captive, virtually "stateless," and also seemingly hopeless, "Euro system."

In effect, what that experience has meant, expresses, in fact, what had been a recurring tradition left over from the Roman Empire, as "empire" is expressed in its contemporary British re-incarnation of, first, the New Venetian party associated with William of Orange, and the subsequent Peace of Paris which established the triumph of the British empire as a globally extended empire in fact. The tradition so expressed, has lately included the Saudi kingdom as the starring, and most wicked companion of the very much presently-existing, present British empire. That presently continued, latter connection, also typifies the same British-Saudi imperial impulses which had launched the original "9-11" horror of the year 2001, first under the then nominal President George W. Bush, Jr., and then, the more recent Anglo-Saudi renewal of "9-11," as expressed recently in Benghazi, under British-sponsored virtual, but evil U.S. puppet-President Barack Obama.

In summation on this immediate point, examine the residue of the span of "world war" since the ouster of Germany's Prussian Chancellor Otto von Bismarck in 1890, a period continuing through the continuing (de facto) state of general international warfare over the span since, in fact, Bismarck's ouster.

Since then, there has been a continuously "off-on" state of general warfare through much, or even virtually all of this planet. This has been continued through to the immediately present hovering of the threat of global thermonuclear warfare. The nominal wars, greater, or smaller, of the span of such global developments since William of Orange's rise to power in Britain, have been essentially successive outbursts of increasingly extreme intensity of violence-in-fact, per capita, and per unit of territory, all within a continuing domain of a

general state of fluctuating pattern of mixed war-fighting intervals, and, otherwise, preparations for reactivated warfare.

With the recent advent of transition from nuclear-fission weaponry, to presently global states of ripeness for a relatively immediate global breakout of general thermonuclear warfare, the world's affairs "have been careened" into a nearby, global state of threatened, imminent extermination of the human species on Earth. We are at the brink of a quality of immediately threatened outbreak of thermonuclear warfare which threatens to become the very early end of the existence of the human species.

All of that pattern to be seen from among those leading political circles to which I have been sharply opposed, increasingly, of late, has been promoted by representatives from the same set of leading players which have included, notably, the effect of what I have just pointed out: those under, particularly, the British monarchy's asset President Barack Obama. That is the same Obama who had now recently re-launched a far more virulent evil than merely an expanded variety of that original version of savagery against the United States' citizenry, and also the world at large, an evil echoing that which had earlier surfaced, in a more limited manner of evil, during the nominal tenure of U.S. puppet-President George W. Bush, Jr.

On "The Oligarchical Principle"

The most essential error of presumption, respecting the cases of such reigning models of oligarchism as that of the worshippers of the legendary Zeus in the war against Troy, is the presumption, as implicitly according to the likeness of the legendary Zeus, that neither the Roman Empire, nor the modern Royal British oligarchy itself, had submitted itself to the same general standards of the civilized existence properly accorded to human beings other than itself.

So, the personal characteristics of the original set of ancient Roman emperors had been more or less "faithfully" adopted by successive European and related models of empire, by, and since the notable case of the Roman empire. By all that which might be considered normal human standards, the fact is, that imperial rule, as under the British empire, or by that empire's auxiliary, the current Anglo-Saudi imperium of that BAE which had been employed for launching of both the original "9-11" and its recent sequel, had been continued under imperial British-Saudi puppets such as President

Barack Obama. Each of those are to be recognized as possessing an actually, intrinsically ultimate, and also evil destiny for itself. This echoes the case of the implications of the execution of any human being murdered in the manner of such as the Duke of Clarence who had been drowned in a butt of Malmsey by the wish of evil expressed on behalf of Richard III. Such are among the notably relevant models for the particular quality of evil expressed by the present case of President Barack Obama.

Consider Emperors and Empresses in the actual, real-life likenesses of such as the Emperor Nero then, or such as the cases of the murder by such as Richard III, or by President Obama now. We have the typical case of Obama's actions, and UNO representative Susan Rice's complicity, in the matter of the maliciously intended wrongful death of the highly respected U.S. diplomat, Chris Stevens, and of his immediate companions. This case of Obama's actions now, typifies the ambitious lackeys of mass-murderous modern imperial oligarchs turned loose.

For the British empire, it is as for the case of the self-inflicted extermination of that satanic Emperor Nero, when his continued presence had affronted even an evil Roman god: that of the real-life principle of the Satan which was and remains as his memorably true master. So, there was Nero's departure, who was to pass pickled in his own self-won torment, vanished from life, as with a great sucking-sound, which left him as ultimately less than nothing, without as much as a consoling sip of the sweet taste of Malmsey given to his mouth. But, let such malefactors live a long life, whether Nero or Obama, dwelling amid the stubbornly persisting, living shame which each now bears in common, forever, that for the great evil he has already done. That was done not only to our republic and its citizens, but, to him, that creature of seething, Satanic-like hatreds, whose guilt has been, simply, on his own account, that for being that tragically despicable thing which those of his likeness have so willingly, and so wickedly become.

That much just said, such is the nature of the foregoing facts which now point to the root of the complexities of the present circumstance which I am presenting to you for your solemn reflections at this point in my account.

The principal source of the brutish developments



In the Japanese fable “Rashomon,” four people are witnesses to a rape; each interprets the events according to his or her particular perception of the crime. Shown: a poster from the classic 1950 film version, by Akira Kurosawa.

now suffocating the legitimate rights of the generality of the citizens of my own United States, and, also, of Europe among other victims generally, represents the continuation of the denial of those rights which my own republic, that of the United States, had once claimed as its own. Thus, our republic has been repeatedly looted through such means as the British imperial grip which is extended via such instruments as “Wall Street,” as repeatedly then, and as now.

It is from that vantage-point, that the obstacles to mankind's future are to be considered, as is being presented, by me, to you, here, and now.

Hence, a Message from Japan

Those considerations now bring us to turning about from the afore-stated facts presented by me this far, to focus attention on another topic, the more joyful alternative of a sharing among us the recollection of the recently happier public experience of the implications of the Mars landing of the craft called “Curiosity.”

The most crucial implication of any significant experience of mankind in society, is not that a relevant event had happened, but, that, it had happened in a manner similar to the instance of a once famous published, modern story from Japan.⁴

In that once-celebrated instance, what was report-

4. The 1950 movie **Rashomon**, directed by Akira Kurosawa.

edly experienced by each figure in that drama, came, in turn, according to the sundry, but differing manners with which the relevant onlookers had, each, chosen to report their relatively unique view of their experience, each systemically different. That case also illustrates, in a different way, my present reading of the effect of the differing, practical human interpretations of the outcome of the successful landing of “Curiosity” on Mars.

The differing, even the conflicting readings of experience of that landing, are to be recognized as comparable to the just referenced example supplied from the literature of modern Japan.

I emphasize, thus, that man is much less defined by what mankind had actually done during some certain time beforehand, than by what both the solitary individual person, and also the relevant society intends to recognize that we must do, as *an event’s presently future significance for mankind*.

In my own personal experience in such matters as that, now, during a span about sixty years of active attention to such matters, I have frequently experienced the fact, that very, very few members of society have yet grasped the kind of actual connection which I have just referenced. I include cases of even most of those persons who might be considered in their own opinion, as “sophisticated.” Errant reactions which have been borrowed from the habits of past times, must be corrected, now.

The relevant, particular difference toward which I am pointing in this moment, lies within the precincts of what those among us may have chosen to consider as of importance. The case of the “Curiosity” landing, demands exactly such a cause for revision of the manner in which the literate classes among our citizens should react. That case of “Curiosity,” when appropriately assessed, should generate the effect of a shocking change, for the sake of which society must now profoundly redefine its outlook respecting almost everything, on Earth, and under the Sun.

In this present case, that of the implications of “Curiosity,” the necessary effect should be a powerful effect of a happy discovery, a discovery which has been adopted by people who have come, really, to know what constitutes a really important discovery of a sweepingly new quality in viewing the future of our species.

In the history of the human species, that is the way we should read our experiences. It is the experience which should define for others, both what the members of our species really are, or have merely chosen to be,

or, what we might come to discover, later, even much later, that we really have been heretofore.

How the Human Mind Actually Works —or, more often, did not

The most essential distinction of the human mind, from that of other known creatures, is that the human being is the only presently known species whose mental processes are capable of knowing the changes which are specific to experiencing the future. To make that point clear, or clearer: in my experience of approximately sixty years of economic forecasting, most forecasters are inherently failures in that profession. The most typical of the failures of professionals of that type, is the prevalent case of systemic failures, the cases of that silly practice known as so-called “statistical forecasting.”

I, for example, have made numerous economic forecasts since my first such, that delivered to my professional circles in 1956, which turned out to be not only a unique success, but the basis, since February 1957, for what should have been foreseen as the rather immediately expected course of the U.S. economy, into the early 1960s. That has been the first of a series of forecasts of crucial turns in the U.S. economy, in particular, over the span of the remaining years of my life. In each of those cases, the usual outcome is not necessarily a specific future date-certain, but a relative turning-point, such as my warning of September 2007, which defined the pattern of that U.S. hyperinflation which is still soaring, at this present moment, into the now onrushing, hyper-inflationary breakdown course correlated with that of western and central Europe presently.

The actually determining considerations under this present, actually global “breakdown-type” of crisis, are not actually monetary, but are physical-economic per-capita in their basis. That is to say that the factors to be considered are not intrinsically monetary, but real.

The Current Examples

Consider the current U.S. hyper-inflationary surge since 2007. The root of this surge into the direction of a hyper-inflationary U.S.A. and European breakdown form of economic physical collapse which is now still on-going, and also, naturally, still accelerating, has been rooted in the repeal of the Glass-Steagall law. The general effect of that repeal was the original basis for the “uncorking” of what has become the trans-Atlantic hyper-inflationary spiral now approaching a general

breakdown-crisis, not only on both sides of the Atlantic, but most recently, in the outbreak of signs of a broader crisis of the type reported from China which we might have anticipated in present global physical-economic patterns.

To carry that case forward in a relevant way, the prescribable remedy for such an onrushing form of general economic crisis, would be a threefold intervention:

- A. Re-install the Glass-Steagall law immediately. Otherwise the present situation is now, already virtually hopeless.
- B. On top of reinstallation of a strict Glass-Steagall law, introduce U.S. Federal credit utterance to counteract the depressed economy with physical-productive and closely related expansion of the physical economy.
- C. Introduce large-scale, medium- and long-term physical investments in long-term basic economic infrastructure, as the principal driver of a physical-economic recovery.

At the present time, in the U.S.A., for example, there is no other reason for hope for avoiding a general economic breakdown within the U.S.A., in particular.

That typifies the same essential principle which was introduced successfully in the just-born U.S. Federal government under President George Washington. Later, altered policies, were largely failed national policies, until the general recovery under President John Quincy Adams, which was later destroyed, in turn, by British financial agencies operating under that nominal Jackson/Van Buren leadership which virtually bankrupted the United States in the resulting Panic which the Jackson-Van Buren Presidency had created. This is clear from a retrospective review of the contrast between the highly successful economic policies under John Quincy Adams, and the destruction of the U.S.A. economy under the incumbency of Andrew Jackson, Martin Van Buren, and the British spy and U.S. traitor Aaron Burr, the latter of whom was key to the economic looting of the U.S.A. accomplished through Manhattan-centered, but British-controlled banking.

That much said on that particular account, this far, the significance of monetary processes in a real economy, is located in the physical-economic processes and their effects, rather than the simply monetary considerations. That is typical, precisely, of where the essence of economic practice lies. The healthy functioning of

any economy which is not essentially a predatory operation, is located essentially in physical-economic realities, rather than monetarist standards. That, for example, is exactly where the basis for competent economic forecasting lies, not in monetarist systems.

The Role of the Human Mind

The most typical failure of the performance of the human individual's mental processes, on all accounts, is to be located, often, in an habituated, stubbornly exclusive obsession of some, with the myth of "the actually past-completed" experiences of sense-perception. The urgently needed alternative to that, were mistakenly mis-classified frequently as "fantasy:" either pleasant, even euphoric, or otherwise.

The issue is, that actually competent physical science is never expressed a matter of simply completed action. It is represented only by a set of aggressively contrary-to-popular rules. Those are the type of rules which should be adopted for the ever-fresh making of better opinions; as the true meaning of competent science radiates, unceasingly, ever-outward, from within its extended reach into the new physically definable riches awaiting the future.

Now, extend the scope of what I have just presented.

To repeat a crucially important point: the essential distinction of creative thinkers, from those of merely ordinary opinion still today, is revealed in experiencing of the silliness of the customary manner in which what passes for "authoritative" economic forecasting, is customarily done, done as "statistical methods of forecasting." Those are methods which are, according to the unfortunately customary, essentially "statistical," and more or less "official" evidence available, and on principle, always systemically inhuman in the end. The practical issue is, "What does 'human' mean, in practice," within the context which I have presented, precisely here.

Enter Johannes Kepler

The future is to be defined for consideration as being a function which is inherently contrary to the systemic incompetence of so-called "conventional," statistical-forecasting methods. The discovery of the remedy for the customary incompetence of the popular, contemporary economic forecasting (in particular), emerged from within modern European science through, chiefly, the initiatives of Cardinal Nicholas of Cusa, as emphasized in his **De Docta Ignorantia** (A.D. 1440). It was

from this source, that Johannes Kepler derived the original general physical principle of modern physical science, a principle best typified for references, by Johannes Kepler's *vicarious hypothesis* as interconnected with, also, the concept of *metaphor*. Without understanding of this connection, there could not be a systematically competent insight into the actually physical principles of economy.

These two notions, of *vicarious hypothesis* and of *metaphor*, are the founding principles of any competent approach to the notion of modern physical science, and, therefore, the unique quality of the powers of the specifically human mind, which are in opposition to all notions of customary reductionist methods. Those principles of Cusa and his follower Kepler, are, thus to be recognized as *the truly universal principles embedded in a competently systemic, improved notion of modern physical science*, that in contrast to the follies inherent in the presumptions expressed as deductions from the popular and also commonly academic categories of "sense-perception."

In modern European cultures' society, the discussion of the reconsiderations of currently future experiences, was introduced chiefly by the greatest of the several leading scientific minds of both the referenced Cardinal Nicholas of Cusa and his nearest co-thinkers, as I have just emphasized here. The appropriate methods, otherwise, have been continued since the discovery of the fundamental principle of physical science among such of Cusa's followers as Johannes Kepler, the uniquely original discoverer of what is referenced today by the discovery of the principle of universal gravitation by, uniquely, again, Johannes Kepler.

That is to emphasize, now here briefly, that the point of Kepler's discovery on that account, is that any competent practice of physical science is necessarily associated with what he identified as the universal physical

principle of "**vicarious hypothesis**" and, implicitly, also as a reflection of a derivation of the same principle, which is known as that of "**metaphor**."

Notably, the common use of "metaphor" during later centuries, most emphatically the Twentieth and Twenty-first centuries, has virtually shed the remains of its original, actually scientific meaning, as also happened, similarly, to the term "hypothesis," that done over the course of the Nineteenth Century, and, worse, beyond. For some readers, the meaning of the use of the term "metaphor," has not only lost all of its earlier intelligible meaning, but that with some consequent serious damage to the human capacity to understand the actually functional meaning needed for the serious work of "science."

It is necessary that I shall return repeatedly to those specific considerations here later, since all competent presently improved approaches to the subject of "physical science," depend on exploding the folly of those notions which attribute the roots of physical science to the attributed foundations of mere "sense-perception." That is otherwise intimated in the work of Bernhard Riemann, Max Planck, Albert Einstein, and the concept of "mind" which Max Planck shared with Wolfgang Köhler.

Repeated emphasis on this point, is crucially required on behalf of competence today.⁵

The Culture Within Science

The root of what I have just pointed out here as the common cause for a loss of scientific competence, is to be located essentially in the modernist (e.g., "reductionist") emphasis on the notion of "sense-certainty."

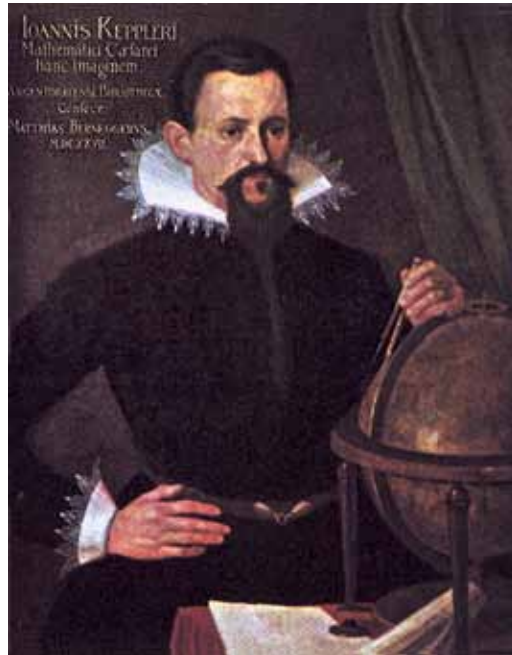

Frankfurt University

It was from Cusa's "De Docta Ignorantia" that Kepler derived the principle of modern physical science, best typified by his vicarious hypothesis (metaphor): "Without understanding of this connection, there could not be a systematically competent insight into the actual physical principles of economy."

5. Cf. The emphasis already placed on this in "The Coming End of the Cult of Sense-Deception." See LaRouche PAC (<http://larouchepac.com/node/24227>) or EIR (http://www.larouchepub.com/lar/2012/3942_end_sense_deception.html).

Thus, as in Cusa's argument in **De Docta Ignorantia**, the competent scientific thinker does not believe in a merely alleged, physically efficient "reality" of "sense certainty." Hence, Kepler's "vicarious hypothesis" and the experienced, related object of apparent "sense-perception," are to be assessed as being mere shadows of what is the actually experienced notion of **Metaphor**, as that which determines the symbolic actuality of what conventional speech defines as the "action" which is customarily identified as "sense-perception," and which is the essential truth of all composed Classical drama and Classical musical composition.

To restate the core of the content of that just preceding paragraph: "sense perception" is not reality; it is but merely the notion, of "the shadow cast" upon the human sensory processes, and is used, thus, as the symbolic surrogate for the actual experience of an event within some actually physical space-time. It is the actually physical principle which is reflected as the mere shadow which the actually physical domain, as distinguished by Kepler's definition of *vicarious hypothesis* and *metaphor* casts upon the human apparatus of sense-perception. Notably, this includes, categorically, among other considerations, a shared consequence of Wolfgang Köhler's and Max Planck's notion of "mind" as being "inclusive," rather than merely "included," in the relevant totality of reference for what lies contained within the bounding process of conception.

It is crucially important to be noted, that the emerging of opening of general warfare during the late Nineteenth Century, began with the events pivoted on, and within the bounds of that 1890 ouster of Otto von Bismarck, which actually unleashed the British measures for what began as "The First World War," a preparation which was continued with warfare which had erupted preceding the death of Johannes Brahms. The worst after-effects of the first period of "World War"-fare, called "World War I," had begun in the same Nineteenth-century period marked out, in one phase, by the assassination of France's President Marie François Sadi Carnot, and, in the relatively later phase, by the 1920s surge of the influence of the figure of monstrous evil known otherwise as Bertrand Russell.⁶

6. The actual warfare which set off what was later identified, mistakenly, as "World War I," was set into motion in 1894, shortly after the assassination of France's President Marie François Sadi Carnot. It was the combination of the assassination of President Carnot, and of the fraudulent pretext for the Dreyfus Affair, which set into motion the preparations for bringing France into the configuration which had al-

We shall return to the subject of what I enjoy identifying as "the riddle of the story from Japan."

II. The Decline Since the Twentieth Century: The Immediately Present Economic Crisis of Our Planet

I now interpolate here, some highly relevant, waiting sectors of what Presidential candidate Governor Romney, has now set forth for my insight, in his conclusion to the immediately just-concluded set of so-called "public debates" between President Barack Obama and Governor Romney. Note that Governor Romney has many short-comings, but, his ostensible rival, President Obama's re-election—even during a transition to a different President, represents a threat to civilization generally. This is the predicament which confronts the United States now, the immediate prospect of general thermonuclear war for as long as Obama remains President.

The presently ongoing, mass suicide-plot, virtually national in scope, called the candidacy of President Barack Obama, is an example of the degree to which some recently incumbent Presidents have dived into their respective political cess-pools. While Obama is an immediate threat to the very continued existence of the United States above all; yet, former Governor Romney has failed to grasp publicly the crucial set of points which are now of the utmost urgency for our republic's survival, even during the immediate short term of the transition to a new term in the Presidential office.

My own estimate, after my having taken note of the Governor's proposals, is that under certain very special, but limited past conditions, he could become a fungible proposition. That were a possibility, if we could now presume certain crucial, changed features of his policies which would make that urgently needed transformation in his current "pitch" which could generate a

ready launched the British imperial intention to set into motion what was to become "World War I," and which set into preparation the revival of active hostilities under the rubric of what as to be mistakenly identified as "World War II." Bertrand Russell was a key figure of corruption launched against competent science with full force during the interval between the Versailles Treaty and the 1939 version of "The Guns of August," and played a crucial and similar role in the period since 1945, up to, and even implicitly beyond his own demise.

successfully workable change in what must be considered as a fundamental change from what had become “the usual kinds of packages.”

Romney’s highly exaggerated admiration of the cult of “the businessman,” is “the proverbial Achilles heel” of his stated programmatic outlook. Romney understands “business” as he has defined it publicly; but his stated intentions are not relevant to the present condition of the world’s economy. What he has proposed so far, is to be commended as an escape from the sheer evil of the eyes of the savagely maddened, “stone-cold killer,” President Barack Obama, but without a certain sort of help, the Governor would not be a successful President. Given the circumstances, the Governor would deserve his election, with certain crucial adjustments definable as within the domain of a science of physical economy, rather than the assured utter catastrophe which a “monetarist businessman” approach would virtually guarantee. That much now said in this present chapter, several very profound issues must be settled quickly.

However, having just stated that much on this matter, we must be aware that, at Romney’s apparent “least worse,” I repeat: he would still fall short of what is required as being a virtually beyond-compromise sort of need. I repeat my intent to indicate here and now, those relatively absolute preconditions for any actually acceptable sort of the most urgently needed changes in what might be identified as a proposal for a “reformed” Romney administration at this juncture. After I have set forth the nature and implications of these basic reforms, I shall turn to relevant matters of details.

A Governor Romney believing himself a “supreme businessman” in the White House, should make both him and any competent economist shudder—if one could find such an economist these days. Given the choices which confront the United States at this state of the national election-process, a President Romney in “the White House,” might be tolerable, if the “businessman” side of his nature were subordinated to the implications of the original U.S. Glass-Steagall law. Without that Law, the U.S.A. were now doomed, and that would now come on immediately.

The fact of that matter is, most unfortunately, that the real state of U.S. affairs at this time, is, that we are likely to be left with Governor Romney as the only ac-



Creative Commons

“Romney’s highly exaggerated admiration of the cult of ‘the businessman,’ is ‘the proverbial Achilles heel’ of his stated programmatic outlook,” LaRouche writes. Romney and Ryan campaign in Norfolk, Va., Aug. 11, 2012.

tually tolerable choice at this time. The question is, therefore, what would be required to induce Romney to become a success, but not as a business-man-in-occupation. He would tend to behave as “a business man,” as he has admitted this weakness in his concluding this present series of debates with President Obama. He has failed, so far, to take into account his lack of the actual scientific competence absolutely required now, if the United States were to survive the crisis which is already accelerating under way.

Turn now to certain crucially urgent passages on the subject of the indispensable economic and matching social reforms immediately required. They are reasonably simple in outline, but profound in implications.

The History Behind Romney’s Crisis Now

Just to begin that core-sector of the needed adjustments, we must summarize the history of modern global warfare systems since the specific “iron date” of the 1890 ouster of Chancellor Bismarck from the German Chancellory: that was the development which had set into motion all of the major warfare on this planet since that time, to the present date.

The set of rules required, against the backdrop of the continued implications of the Bismarck ouster of 1890,

is what must be called into play for assessing former Massachusetts Governor Mitt Romney's essential national-economic and related social concerns. Those concerns of his have essentially nothing which does not fall far, far short of the actually desperate economic and social crises of either the United States, or the world as a whole at the present time. However, in contrast to Romney's implicit such short-falls, there is no condition under which President Barack Obama is fit for office as U.S. President. Whereas, Governor Romney's short-falls lie in his shallow attractions for a sort of pragmatic "business management lore," but are nonetheless, actually "old hat" business management lore, which has lost those pragmatic, short- or medium-term "business" viabilities, which went out of circulation with certain reckless lunatics' repeal of President Franklin Roosevelt's original Glass-Steagall Law.

The degree of functional validity that the economic and related social policies require to meet the actually required standards, would require that his policies take into account the actually practical issues presently confronting our planet as a whole—and beyond—which require us to step virtually outside all of the "programmatic issues" of the campaign of competition under the British Queen, which momentarily pits Governor Romney, presented as "fast forward," against the momentarily incumbent Barack Obama.

Romney has learned some useful lessons, but those apparently fail to reach the category of the ABCs of economic survival under present conditions now.

At the Threshold of "General Death"

The essential preconditions, which it appears, presently, Governor Romney does not yet know, are nothing less than those minimal preconditions on which the continued existence of a viable U.S. economy most ur-



EIRNS/Andrew Spannaus

The world economy as a whole, has witnessed an accelerating rate of physical-economic decline, since the onset of the 1970s "deindustrialization," culminating in the 1999 overturning of Glass-Steagall, and its aftermath. Shown: Bethlehem Steel plant, July 1999.

gently depends immediately, now. The consequent conclusion respecting Governor Romney's qualifications, is that the ordinary qualifications of the Governor as a standard of a certain type of successful "business man," are "respectable;" but, unfortunately, he shows no public insight into the minimal requirements for the current survival of the present U.S. economy under the conditions since those set into motion by a systemically incurable trend of hyper-inflation since the repeal of Glass-Steagall in the U.S.A. itself, especially since the breaking-point reached in, approximately, 2007, and into economic Hell itself in late 2008.

The world taken at large, at this time, signifies that the world economy as a whole, has been caught up in an accelerating rate of combined physical-economic decline, and a galloping rate of global hyperinflation: a form of hyperinflation whose character has already now departed all possibility of any recovery from this under presently "conventional" anti-inflation recipes.

So far, Governor Romney has shown scant inkling of a comprehension of this fact. While his projected reforms fortunately lack the characteristic quality of personally Satanic evil of an Emperor Nero, or an Adolf Hitler, a type which has been presently oozing out from

the political hide of President Obama; yet, Romney himself appears to lack any sign of the perspective which is indispensable for effectively challenging the presently accelerating rate of spread of global hyperinflation.

More radical reforms for this crisis are indispensable, and, they exist, as I have prescribed those methods, but Romney has shown no sign that he yet understands that kind of situation. Therefore, what do I mean in pointing toward an alternative as being an active choice under presently immediate circumstances?

How the World War Began

If any significant distinction is to be made between the British empire's spreading of what was to become known as the British-Japan war against China and the later phases of so-called "World War I," it was the assassination of President McKinley, which worked to the effect of bringing an implicit child of treason, sometime U.S.A. Vice-President Theodore Roosevelt, into the Presidency through the means of the assassination whose effects were traced explicitly, by name (that of the traitor, his treasonous uncle James Bullock, by his name), to the network accountable to wretched Vice-President Theodore Roosevelt himself. The treasonous features of President Theodore Roosevelt's past as an incumbent trained under his uncle, the former leading British spy against the United States, were therefore thoroughly British, in what were the keys to bringing in another scoundrel of kindred treasonous breed, the later Woodrow Wilson, into play.

As U.S. President, Woodrow Wilson was notable for such White House achievements as launching a vastly expanded rebirth of the Ku Klux Klan directly from the White House itself, and was the worst among the political operatives in the conduct and outcome of a Versailles treaty which quickly mustered the arrangements for what was to be misnamed as "World War Two." Lest something had been left behind in that transition, another President of the United States, Warren G. Harding, was said to have died of an attack of fresh shell-fish poisoning, while dining, astonishingly, during a railway trip in the middle of the desolation of the American desert. (I can plead that I was an infant during that time.)

President Franklin Delano Roosevelt was a far, far different case; the best authorities in the matter have attested with evidence that Winston Churchill bitterly

hated that President. President Franklin Roosevelt suffered the wretched Wall Street crony Vice-President Harry S (no period) Truman. The General, and, later, President, Dwight Eisenhower, contributed much to saving the U.S. Republic. President John F. Kennedy was not much feared to be a serious threat to London's Wall Street clowns, at first; but, when he did appear to be such a serious threat to British interests, President Kennedy was suddenly dead by assassination, amid the same antipathies which also menaced France's President Charles de Gaulle, and which were also part of the great warfare in Asia against which General MacArthur—the most brilliant commander of forces, on point of principle of method, in modern U.S. history—had warned, which brought the United States into a condition of accelerating disasters.

That turned out to be the end of the true independence of our U.S. republic this far.

Since that time, our United States has, frankly, slid into virtual economic (and, also other varieties of) Hell. In fact, since the murders of Jack and Robert Kennedy during the 1960s, our U.S.A., and much of the world, besides, has been sliding at uneven, but unbroken rates, into a sheer Hell, with much, much worse to come, under the very worst of them all so far, the "kill-crazy" mad-man, Barack Obama. Voting for Obama is virtually taking out membership in a suicide-plot, even against oneself!

I sense a demand from some quarters: "Explain what you mean!"

I now reply.

III. Human Nature, Then and Now

Taken at so-called "face value," and looking backward from modern, and even medieval, and ancient cultures, even the history of modern Europe remains truly a mystery, or a faith in mistakes, to most even in the relatively more familiar elements of the trans-Atlantic region. From the standpoint of a competent practice of science, what is required is a deeper insight into the human mind than is available through reliance on the notions of sense-perception as such.

The powers of the human mind must be regarded by aid of recognition of that which underlies the ordinary notions of the experience lodged within the bounds of sense-perception as such. For ordinary purposes other-

wise, direct observation of sense-perceptions is useful, even indispensable in part. That evidence is usually useful, until we seek to penetrate the domains within which the powers for sense-perception fail: what lies beyond what sense-perception does encompass; to what extent does such a differentiation serve us as necessary, even indispensable?

The insight into such matters of the human mind, as best known in ordinary circumstances, is found in the performance of Classical musical compositions such as those of the heirs of Johann Sebastian Bach, such as Bach himself, Arthur Nikisch, and Wilhelm Furtwängler. However, a deeper insight is found in the followers of Nicholas of Cusa and of his follower Johannes Kepler. The significant differences which may be located there, are exposed in modern science through what I have identified above in preceding chapters of this report, as the notions of *vicarious hypothesis*, and the related, actually subsuming notion of *metaphor*. The significance of that paired set of distinctions of *mind* from mere *sense-perception* lies in the evidence, as presented in connection with Kepler's unique achievement of the notions of mind which were adduced from physical-scientific experiment as proofs which supplied the only demonstration of those universal qualities of universal principles knowable to mankind, as in the instance of Kepler's unique discovery of the principle governing the existence of any competent notion of a principle of universal gravitation, a notion which is reflected in modern physical science by the exemplary influence of such as Bernhard Riemann on the specificity of the leading discoveries by Max Planck and Albert Einstein: both of whom illuminated the physical reality of man's access to knowledge of principles of the physical universe.

That specific correction, made by those indicated



“We human beings, ostensibly unique among the other creatures of our world, should consider the fact, that the adoption of sense-perception as the specific ground-basis for science, is an obvious absurdity.” Here, Albrecht Dürer’s “Melencolia” (1514): The objects of sense-perception are inadequate to achieve true scientific knowledge; hence, “Melancholy.”

authorities as human beings, constituted proof beyond concessions to sense-certainties and made independently of axiomatic presumptions derived from sense-perception as such. It is now, virtually a greater part of a century, since Planck and Einstein made their crucial discoveries on this account, and aided the by shared exploration of the function of mind as such in and of itself, that mankind has finally touched upon a sound view of the universe from the vantage of an actual reality. It is thus, in the matters of this discussion this far of the

human mind, insofar as it is capable of knowledge independent of mere sense-perception as such, that we grasp the implications of the view of the human mind which has finally enabled us to take upon ourselves the practical role of the work of the human mind as such: a point, incidentally, emphasized in the wrestling between Plank and Köhler in confrontation with the reductionist standpoint.

The specific kind of error which has tended to block the significance of such as Johann Sebastian Bach for the discovery of the underlying principles of musical practice, poses the same issues. The point to be stressed is the following.

We human beings, ostensibly unique among the other creatures of our world, should consider the fact, that the adoption of sense-perception as the specific ground-basis for science, is an obvious absurdity. The fact that that might be a popular habit, is not a scientific proof. How might, we therefore, adduce some essential facts about the parts of the universe which we inhabit most immediately, and claim that that quality of human sense-perception defines, in the sense of enclosing, our universe?

That question which I have just posed, begs two

considerations immediately. First, how can you claim to understand the universe in which we live, within testing the realities of that presumed relationship against proofs which depend upon ignoring the lack of a proof of the existence of the universe which, kindly, presents us with an habitat? The nature of the error of such presumptions respecting the nature of mankind should be obvious. It is only when mankind is asserting its powers within and upon the universe we inhabit, that we barely begin to define the real universe itself. The issue, the question is whether mankind itself, is enabled to infuse its controlling influences within the bounds of the Solar system, and then, other places.

This achievement, which I have demanded be identified in the course of this publication, must be accepted as the test of whether you have any provable claims to knowledge of the principles of the physical universe at all. If we accept the notion, that mankind is, indeed, bred as mankind, as a force whose power is that of changing the universe, at least somewhat, as a power which inhabits our Solar system, and implicitly beyond, the we inhabit a creation, and we are apprentices in its work of creating with the permission of Who might be the owner.

EIR Special Report

Obama's War on America: 9/11 Two

In 2001, the Bush-Cheney Administration was complicit with the British and Saudi monarchies in permitting and covering up the 9/11 attacks; today, President Obama's collusion with the Saudis and the British was responsible for the attack on the American consulate in Benghazi, Libya on 9/11/2012.

I. Obama's 9/11

The Obama Administration's negligence and coverup of the Benghazi murders offers perhaps the last opportunity for the patriotic leadership of the United States to remove Barack Obama from office.

II. The London-Saudi Role in International Terrorism

EIR has persistently tracked down the evidence which shows that the 9/11/2001 atrocity was an act of war against the United States, not by Osama bin Laden, but by the British Empire and the Saudi monarchy.

III. 9/11 Take One

The Cheney-Bush Administration used the 9/11/2001 terrorist attacks to attempt to ram through a fascist dictatorship, an agenda LaRouche had forecast eight months before.

Price **\$100**

(Available in paperback and PDF. For paper, add shipping and handling; Va. residents add 5% sales tax.)

EIR
Special Report

Obama's War on America: 9/11 Two



October 2012

Order from EIR News Service **1-800-278-3135** Or online: www.larouche.com

A NUCLEAR POWDERKEG

Is Mankind Smarter Than the Dinosaurs?

by Helga Zepp-LaRouche

It's almost inconceivable: The world is not just on the brink of war, but already in the midst of a dynamic that could very quickly lead to global thermonuclear war and the extinction of the human species; yet in Germany, there is no debate in the media about the threat, none of the parties that are represented in the Bundestag has anything to say about it, and there are no mass demonstrations in the streets. Will human civilization come to an end under a state of general anesthesia, because we are too busy with our daily lives?

At the height of the medium-range missile crisis in the early 1980s, when the deployment of the Soviet SS-20s and the U.S. Pershing II missiles in Europe had reduced the warning time for the launch of nuclear weapons to a few minutes, many hundreds of thousands of people were on the streets, warning against the threat of a “nuclear holocaust.” Over 10 million people worldwide demonstrated before the launch of the 1990-91 Gulf War, while in Berlin alone, there were over 500,000 on the streets before the Iraq War in 2003.

A Drumbeat for War

And today? Since the “humanitarian intervention” in Libya and the brutal murder of Qaddafi last Fall, there has been a growing concentration of nuclear weapons in the Persian Gulf, the Arabian Sea, the Indian Ocean, the eastern Mediterranean, and the western Pacific—weapons whose “overkill” capacity could de-

stroy the human species and probably everything else, a few dozen times over. The policy of “regime change” plunged first Iraq, Afghanistan, and Libya into chaos, and now the conflagration has spread not only to Syria, but to Turkey, Lebanon, and Jordan, while the entire Middle East looks like the Balkans before the First World War, with several fuses for catastrophe already burning.

The three-week “Austere Challenge 2012” maneuvers, which had been delayed since the beginning of the year, began on Oct. 21, with 3,500 U.S. soldiers from the U.S. European Command and 1,000 Israeli soldiers. This is the largest joint air defense exercise of the two armed forces, whose goal is to strengthen their “interoperability.” U.S. Aegis-class ships are deployed, which are a key component of the ballistic-missile defense systems which the United States and NATO are constructing, and which have been denounced by Russia and China as a dramatic change in the strategic balance.

Officially, the maneuvers have nothing to do with specific current events. The *Wall Street Journal*, however, wrote on Oct. 22 the exercise “signals to Iran that an attack on Israel would involve drawing the U.S. into a conflict.” American military circles around the Joint Chiefs of Staff, who are opposed to a military strike against Iran, however, are acutely concerned that the maneuvers could provide the context for a provocation of third parties, drawing the United States into a mili-



IDF/Staff Sgt. Yuval Haker

Soldiers in the joint U.S.-Israeli military exercise, Austere Challenge 12, on Oct. 24. While officials stress that these maneuvers occur every few years and are not a response to specific events in the region, the dangers of a staged incident or provocation are high in the current powderkeg situation.

tary operation against Iran through a staged incident, which would, in all likelihood, mean a Third World War.

The trail of destruction across the whole region is horrific. The war against Iraq, far from being a “cakewalk,” was staged by Tony Blair and the U.S. neocons on the basis of blatant lies; 6,000 American soldiers and civilians lost their lives; at least 125,000 Iraqis were killed, 350,000 wounded, 2.8 million displaced; and it all cost the U.S. taxpayers at least \$3.5 trillion. In Afghanistan, more than 3,200 NATO soldiers have been killed, including 53 Germans, and according to the German Institute for Economic Research, the deployment of the Bundeswehr (German army) alone has already cost EU17 billion, while the United States has paid considerably more than a trillion dollars.

A Spiral of Terror

The drone war, started by Bush and Cheney and expanded by Obama, has so far killed some 5,000 people, including many civilians; it has not reduced the number of terrorists, but on the contrary, has enormously increased the recruitment potential for al-Qaeda and a

myriad of spin-off organizations.

The *Washington Post* ran a three-part series Oct. 23-25 about a new project of the Obama Administration, in which a so-called “disposition matrix” of character traits has been compiled, which is supposed to allow the identification of potential terrorists. Obama presides over the weekly decision-making process as to which individuals on the so-called “kill lists” will be selected for drone attacks.

Terrorism experts agree, according to the *Post*, that the short-term “successes” of the drone killings perpetuate the spiral of terror, because for every dead terrorist, a large number of new ones are recruited, whose hatred of the U.S. and the West as a whole grows immeasurably. “The

problem with the drone is, it’s like your lawn mower,” Bruce Riedel, a former CIA analyst and Obama counterterrorism advisor, told the *Post*. “You’ve got to mow the lawn all the time. The minute you stop mowing, the grass is going to grow back.”

You can hardly get more inhumane than this. At least one in every four victims of drone strikes is a civilian, and of these, over a quarter are children. Indictment, proof of guilt, a trial? No way! The definition of a militant is: anyone who is killed by a drone. So there will never be a shortage of terrorists!

The policies of regime change and drone warfare, started by the neocons and escalated by Obama, have led to, if anything, an enormous loss of prestige for the U.S.: Abu Ghraib, killings transmitted by live video, violations of the Geneva Conventions, training of Afghan soldiers and policemen who then massacre their trainers, countries that have been bombed back to the Stone Age and where tribal and religious wars are being kindled.

The previous heads of these states were certainly no Western-style showpiece democrats, but in their secularly governed countries, different religions coexisted

in a relatively unproblematic way, and living standards improved through economic development. The policy of regime change has contributed to turning the tender shoots of the Arab Spring in some countries into a repressive version of Islam, making the Muslim Brotherhood seem like liberal softies. Russian Foreign Minister Sergei Lavrov rightly warned of the danger that the Arab Spring will become a nuclear winter.

It is clear how close are we to a thermonuclear catastrophe, when none other than Zbigniew Brzezinski speaks out vehemently against arming the rebels in Syria, condemns the British and French policy as responsible for the disaster, and instead urgently advises working with Russia and China to propose an acceptable solution to Syrian President Hafez al-Assad. Brzezinski was no less than the architect of the Trilateral Commission's policy in 1975, to play the "Islamic card" against the Soviet Union in Afghanistan and train the mujahideen, which is where the disaster began. Now, Brzezinski warns that there is a threat of religious warfare throughout the region between Shi'ites and Sunnis, which would, among other things, have catastrophic economic consequences for Europe. Therefore, he says, cooperation with Russia and China is urgently needed.

The strategic situation is now more dangerous than even during the Cold War, the Cuban Missile Crisis, or the medium-range missile crisis. We are on the brink of the thermonuclear annihilation of the human species. Among other things, 450 land-based Minuteman III nuclear missiles are in a state of high alert, and could reach their designated targets in 13 minutes or less, by order of the U.S. President, and obliterate the world. In the early 1980s, the NATO and Warsaw Pact nuclear arsenals were on "launch on warning" status, in case of a suspected or actual attack by the other side, because the warning time was only a few minutes. Today the entire nuclear arsenals of NATO, the U.S., Russia, China, India, Pakistan, Israel, Britain, France, and North Korea are probably also set at "launch on warning." Mankind is minutes away from being wiped out. If you can still sleep well in the face of that, there's no help for you.

This whole situation is the reason that American statesman Lyndon LaRouche is trying to encourage, for the post-election period, a Presidency that is above party politics, that governs on the basis of the Constitution, and that especially puts a peaceful solution with Russia, China, and other sovereign states on the agenda.

The policy of regime change and supposed humanitarian intervention must be ended, and international law reinstated, as laid down in the UN Charter. The principle of the Peace of Westphalia—i.e., the recognition of national sovereignty, which ended 150 years of religious warfare in Europe, and which is the basis of international law—must absolutely be upheld again.

We also need a real development strategy for the entire region of Central Asia, Iran, Iraq, the Gulf, Israel, Syria, Turkey, Afghanistan, Pakistan, Egypt, and the Mediterranean region. If the money had been spent on real development of these countries and the improvement of living standards, instead of destructive wars, subversion, and drones, then this region would not be the powder keg for a Third World War, but rather these countries would have an interest in building upon the best traditions of their respective cultures.

In the age of thermonuclear weapons, war can no longer be a means of conflict resolution. Either we end wars once and for all, or we end the human race.

Translated from German by Susan Welsh

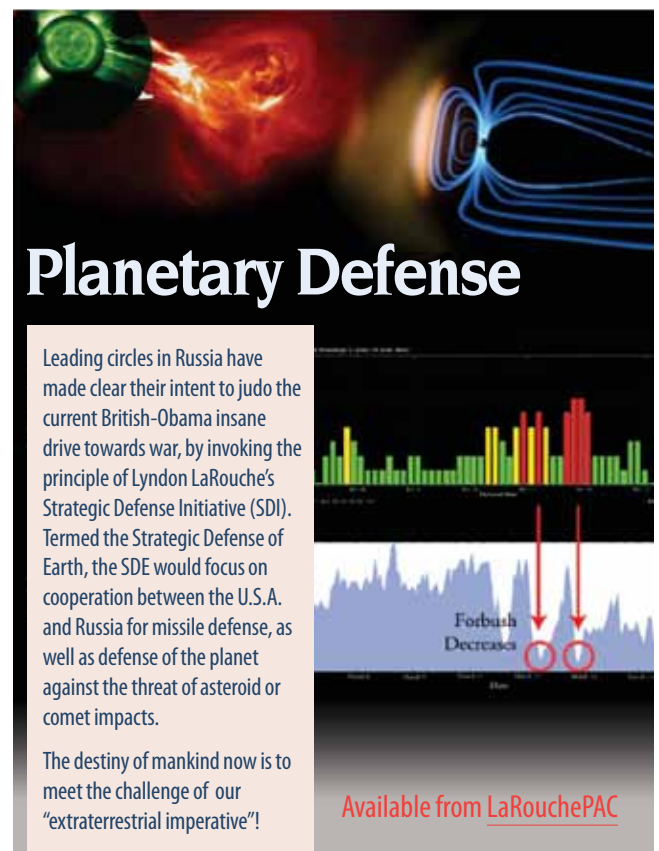

Planetary Defense

Leading circles in Russia have made clear their intent to judo the current British-Obama insane drive towards war, by invoking the principle of Lyndon LaRouche's Strategic Defense Initiative (SDI). Termed the Strategic Defense of Earth, the SDE would focus on cooperation between the U.S.A. and Russia for missile defense, as well as defense of the planet against the threat of asteroid or comet impacts.

The destiny of mankind now is to meet the challenge of our "extraterrestrial imperative"!

Available from [LaRouchePAC](#)

The Two Kingdoms of Terror

The LaRouche Show on Oct. 20 hosted two EIR specialists, Arabic-language editor Hussein Askary, who is based in Stockholm, Sweden, and New Delhi correspondent Ramtanu Maitra, based in Leesburg, Va. Each addressed the question of the Anglo-Saudi terrorism behind 9/11/2001 and 9/11/2012.

The Internet radio program runs every Saturday at 3:00 p.m. Eastern Time, at <http://larouchepub.com/radio/index.html>. This week's host was Marcia Merry Baker.

Hussein Askary: First of all, the Kingdom of Saudi Arabia and the British Kingdom are actually inseparable; they are one entity. Saudi Arabia, from its inception almost a century ago, was a British project. And also, the domination of the so-called Saudi and other sheikdoms in the region coincided with the British move into the Indian Ocean and India in the 18th Century; but then later became more and more involved in running the affairs of these countries. And all these small countries along the Persian Gulf and Saudi Arabia were created, physically and practically, by the British.

Now although there is a long history of the British Empire's operations in Asia, in Southwest Asia, the thing is that since the murder of Qaddafi last October, we were put on a trajectory towards a global conflict. The United States, NATO, the British are face-to-face now with Russia and China, right in Syria, in the same region, where the Saudis, and the British, and the Obama Administration are very active in supporting a bloody war, which could expand beyond Syria into the whole of Eurasia, and get us into a direct conflict with Russia.

As Lyndon LaRouche has warned, that kind of conflict is not going to be irregular warfare, as we saw in



EIRNS/Michelle Rasmussen
Hussein Askary

Afghanistan in the 1980s, but it's going to be thermo-nuclear war.

The real issue here is that the British Empire's intention—or the Anglo-Saudi Empire, we can call it—is to destroy the idea of the sovereign nation-state. That includes all nations, not only in the region, but including the United States and Europe. There are different methods being used to destroy this principle of national sovereignty. In Europe, we see it here today, in the banking and financial crisis, whereby a super-European state is being established, or the intention is to establish it. In the United States, it's to turn the United States from a sovereign republic into an empire, which would be a subsidiary of the British Empire.

When, in October last year, Russia and China vetoed the UN Security Council resolution for intervention in Syria, what they were discussing was exactly this principle of national sovereignty. That this is the last front line we have before we go into a world war, and that has to be protected and preserved.

Religious War

So this is really what the story is. And Saudi Arabia and its allies—Qatar and Turkey right now—are actively involved in promoting this option for the British Empire, because they have their hands on control in the region and they are using this religious aspect, which is really a very, very dirty and nasty way of running warfare. We are faced with actually religious warfare in the whole region. It did not start with the murder of Qaddafi, but since the so-called Arab Spring, which was militarized by the Obama Administration and NATO, and the British and their allies, we have turned the whole thing from a protest against economic injustice, into turning the whole Southwest Asia/North Africa region into fanatic religious states, with the so-called Salafis and Wahhabis taking over, with money and weapons in the region.

This has been a project in progress for a long time, as I said, since the British got into the Indian Ocean. The Saudi Kingdom, I have to say, is not really a state; it's some sort of a company. It's like the British East India



Wikipedia Commons



alrafidayn.com

The beautiful Al-Askari Mosque in Samarra, Iraq, built in 944, is a shrine beloved of Shi'ite Muslims. It was bombed in 2006 (shown) and again in 2007. The British and Saudi empires are fanning the flames of religious war.

Company, which was not an English government. It was a financial-economic enterprise, which had armies and intelligence organs, and used the people in England and the colonies as the cannon fodder and the tool to run the policies for the British oligarchy and empire.

Unfortunately, it created a monster in its own image, which is Saudi Arabia and the other Gulf States, which are absolute monarchies. There are no elections, there are no real human rights for people. And these countries are being run—Saudi Arabia is a perfect example—by tribal alliances, intermarriages, and control of religion, which is the so-called Wahhabi sect or cult. It's not really a doctrine of Islam; it's a cult which was established in 1744, when Muhammed Abdul Wahab, the founder of the cult, made a political alliance with Muhammed ibn Saud, who is the great-great-grandfather of the current king. And they established a political entity.

But they were, actually, in the area of Diriyah, in the eastern Arabian Peninsula (in the northern part of the capital, Riyadh), they were bandits, who were attacking other tribes, and looting them. They were attacking and looting pilgrims, who were coming from Iraq, from the other areas in the Ottoman Empire, and looting and raping.

They were a bunch of bandits, who expanded their power through their brutality, but also with British support. And by 1818, they became so powerful that they threatened the Ottoman Empire, and the Ottomans sent the son of Muhammed Ali Pasha from Egypt, and he almost finished off the al-Saud/Wahhabi alliance, and the al-Saud were sent into exile.

But in 1892, they had come back, and the British had become established there, in the whole Gulf region of their colonies, in what today is Kuwait, Qatar, Bahrain, the United Arab Emirates, in Yemen, Aden, and so on. They had established themselves on the ground. But in 1892, when the al-Saud family came back from exile, they entered an alliance and signed agreements with the British Empire, to get both financial support and weapons, to recapture the areas which had been under their control.

During World War I, the British entered the war with the Ottoman Empire. The al-Saud family and the Wahhabis became a key factor in the fight against the Ottomans. In that process, al-Saud and their tribes, and the Wahhabis, got control of most of the eastern Arab Peninsula. Then, by 1925, still under the control of British Army officers, including one called William Shakespeare—unfortunately, he had the same name as William Shakespeare—but also, Sir John Philby, who was the advisor to King Abdullah Aziz al-Saud, and they captured the western part of Arabia, called al-Hejaz, which was under another of the British allies, the Sharif Hussein family (the Hashemites). And Sharif Hussein was sent into exile.

Then, by 1932, Abdul Aziz al-Saud established himself as king over Saudi Arabia. To my knowledge, this is the only country in the world which is named after the king. So Saudi Arabia is the al-Saud family's own enterprise, which is a real tragedy. Because it's not that the case that there are no people in Saudi Arabia who could govern themselves and establish a modern state. The



The alliance between the House of Saud and the British Empire. Above, Prince (and future king) Faisal (front) leads the Saudi delegation to the Versailles Conference in 1919, with British agent T.E. Lawrence to his left; on the right: Prince Faisal (center, top) in 1919 with other dignitaries and British agent St. John Philby, to his left.



problem is that the alliance with the British Empire had established the al-Saud family, and the Wahhabi cult, as the main power in the country.

Oil and Nationalism

And especially with the discovery of oil in 1938, the resources of Saudi Arabia turned from being merely a strategic asset, into an economic-financial-strategic asset in the British Empire's world order, especially after World War II. The oil money was used and has been used, and is still used, for British operations of destabilizations. The most famous of them was the Afghan War, where the so-called jihadists in Afghanistan were supported with Saudi and other Arab money, and arms and intelligence from the British and the United States' different organs, to start the war against the Soviets.

But even before that, when after World War II, you had nationalist movements in Egypt, in Syria, in Iraq, in North Africa—these were nationalist movements against imperialism. The British, who were dominating most of these countries—they were the colonialists—and the puppets they had put there after World War II to run the countries were threatened by the nationalist movement. What the Saudi role was, and the so-called Islamist movement, has

been to tarnish all the nationalist movements as “communist, godless” people, just to undermine the nationalist movements in these regions, and the whole idea of establishing modern nation-states.

By 1968, actually, the Saudis had been involved in many coup attempts in Syria and against Gamal Abdul Nasser in Egypt. They supported the Muslim Brotherhood to destabilize Nasser, all the way from 1952, to his death in 1970.



Egyptian President Gamal Abdul Nasser was targeted by the Saudis and the British because of his nationalism and desire to create a modern nation-state. Here he is being cheered after nationalizing the Suez Canal Company, Aug. 1, 1956.

CIA

This operation was to create the so-called religious alternative, the so-called pan-Islamist movement, or pan-Islamist entity, as a replacement for the nation-states and the anti-imperialist nationalist movements. It was spearheaded by the Saudis, especially from 1969, when other British puppets in the region, the so-called extremists in the Zionist movement, set fire to the al-Aqsa Mosque in Jerusalem. And since then, the politi-

It is a false picture that there's a Sunni-Shi'a conflict. That is not really the issue. The issue is that the Saudis, and the British behind them, have been pushing the sectarian conflict in the region, under the pretext that they represent the Sunnis.

—Hussein Askary

cal-military conflicts have been turned into religious conflicts.

The Saudis were sitting on a large amount of financial resources, intelligence, and military backing from the British, and later the United States, *and* their religious control, because tens of millions of people go every year in pilgrimage, from all over the world, to Mecca and Medina, in Saudi Arabia. So the Saudis have been using both their religious and economic position there, to spread the rigid so-called Wahhabi, or Salafi, teachings, which are actually a threat to other Islamic established sects.

Not only do we have the classical picture that Dick Cheney was pushing, during the Bush Jr. Administration, to create a so-called Sunni alliance against the Shi'a alliance—the Shi'a being Iraq, Iran, and Syria, and Hezbollah in Lebanon; and the Sunnis being the other Arab countries. But it's not really true, because the Wahhabis are a threat to the other Sunni sects, too. Because of geopolitics, they say, "We support the Sunni movements in Syria and Iraq, against the Shi'a influence, and against Iran." But in the end, they would be threatening the other Sunni sects, like the Maliki, Hanafi, Shafi'i, and Hanbali, which are dominant in Iraq, in Turkey, in Syria, in Egypt, and so on.

So it is a false picture that there's a Sunni-Shi'a conflict. That's not really the issue. The issue is that the Saudis, and the British behind them, have been

pushing the sectarian conflict in the region, under the *pretext* that they represent the Sunnis. But even the Sunnis are totally scared about the Wahhabi influence in these countries, and it's spreading like wildfire all over North Africa, even in Egypt. And ironically, they are in conflict now with even the Muslim Brotherhood, because they don't regard the Muslim Brotherhood as following the pure teachings of the so-called Salaf there—what they think of as the original Islamic way of worshipping and living. But it has very little to do, really, with the origins of Islam. And there are many Sunnis in the Muslim countries who are now warning against this Salafi/Wahhabi invasion of these countries. And they understand it as part of an imperial force.

British-Saudi Terror

Now what we have had, also, is the Wahhabi/Salafi movement as the basic ingredient in the creation of the so-called Islamist terrorist groups, like al-Qaeda and their off-shoots, which started in Afghanistan, with the indoctrination of Wahhabi cult thoughts; these are spreading all the way to the borders of Russia and China, in the Caucasus in Central Asia, and in the western part of China. They are trying to increase their influence, and to use these Wahhabi and Salafi militant groups as tools against Russia and China, to destabilize these two countries.

EIR has actually had the record on this—both the history, but also practically, who is who, and who is running what. I recommend that the new [report](#), "Obama's War on America: 9/11 Two," should be read by everyone who is interested in solving the question of terrorism. There are no so-called private terrorist groups! Al-Qaeda was a Saudi-British creation; it was run by the British. In certain periods, you have differences between them. But in the end, they cannot survive without the financial support, weapons, intelligence, and even protection, but also drug money, which is being laundered in the Gulf countries.

Now Obama wants to bomb some groups in Libya, the people who killed Ambassador Stevens; these are not a small group, not even a large, separate group. These are all part of the whole Anglo-Saudi army which is now being run as a supranational force, a force of globalization. In economic globalization, you have the multinational companies; and now you have the multinational terrorist groups, who can run over borders of sovereign nations. And that's really the issue with the

so-called Islamist terrorist groups. *They are being run as an international army by the Anglo-Saudis, to destroy nation-states, and terrorize populations to go to the side of the Saudi-Wahhabi cult.*

So that's where we have the danger, the abolishing of the principle of national sovereignty, creating religious war situations all over Eurasia and Africa; even in Sub-Saharan Africa, these Wahhabis are active right now. And this will put us into a direct confrontation with Russia and China—a global conflict. So that's really the issue.

And time is running out actually for these countries, because this religious fanaticism, which is spreading all over the area, would be very, very difficult to wind back, to go back to a time when people were thinking about being citizens in modern, secular nation-states, where religious practice and religious rights were protected. These are modern nations, not religious states. The Turkish government maybe believes, or is dreaming of an Ottoman religious empire, and to establish empires across borders with this religious, fanatic belief structure.

So that's really a very, very big danger to the world, but also to the societies there, who can make great contributions to the world, economically, culturally, and so on; but now these countries are being destroyed. That really has been the intention of the British Empire, by creating and supporting the Saudi Kingdom.

Marcia Merry Baker: Everyone should recall that the commission that studied who was behind 9/11 [2001], and how it came about, has a section in [its report] that Obama will not release; before him, Cheney and Bush would not release it—it was 28 pages. It was former Senator from Florida, Bob Graham, who has called for this to be released. He knows what's in it, and this is the kind of thing you were just describing, that we presume is there. We're told it's there. And Obama said in 2009, a month after he was inaugurated, he told some of the families connected to those 3,000 people killed in New York City, "I will see that it's released." He has seen that it's even more tightly locked up!

So everything you just described, the nature of what you described, is horrendous and places it in history, in terms of what the British Empire did in India. We have quite a task to turn this back, but it again focuses on the task, that people should *un-elect* Obama; we should have gotten him out of office, through impeachment or coercion, even before now.

But Tanu, you may want to say something on that aspect of this, and we can follow through.

It Didn't Start with 9/11

Ramtanu Maitra: What I notice is that the British-Saudi thing that Hussein Askary described, has happened through the centuries. However, one thing that really has created this enormous threat that exists today, definitely did not start with 9/11: 9/11 is a manifestation of that. Real problems started when the Soviets came into Afghanistan, and then, the entire anti-Soviet forces in the world, which included everybody who is considered as not a communist, all the religious fanatics, the democracy-lovers, and people who said they believed in the sovereign nation-state—all of them came together and started bringing up armed terrorists in Afghanistan, with the intent to defeat the Soviet Union. And that was done.



EIRNS/Stuart Lewis
Ramtanu Maitra

After the Soviets invaded Afghanistan, over the next ten-year period, enormous amounts of money and enormous amounts of arms training were given, and the whole area in this process got compromised, because anybody who wanted to prevent the Red Army from moving into the Arabian Sea or eastward, was eager to help them.

So, in 1989, when it was over, you had thousands of these trained terrorists, who became available then at a very cheap price to all those who wanted to use them. These terrorists had nothing, they had nowhere to go, so they lingered in Afghanistan-Pakistan's undefined border areas. Most of the countries, like Algeria, Morocco, and others, Saudi Arabia and other Gulf countries, who had supplied these individuals to fight the Soviets, were not interested in taking these people back. They had given them, but they didn't want to take them back, because these monarchies in Arabia were, and still are, extremely fragile. They're run by families, and they rule these countries ruthlessly, suppressing the population. Often they take the sectarian line to suppress their people; often they adopt other methods. Nonetheless the basic objective of these small families

that rule those countries is to continue maintaining their rule over Arabia.

So, they didn't want to take them back, because they know these people could be extremely dangerous, and could turn around and unseat them in no time. So, the British at that point in time, picked up a lot of these terrorists. And they got their projects all set up.

One of these projects, was, of course, to get rid of Muammar Qaddafi. Qaddafi was independent. Qaddafi had his flaws, but like some other rulers, he was very stable at that point in time. Qaddafi's Libya was making a lot of money, and Qaddafi was distributing a lot of that money to his people. Despite the tribal tensions that existed in Libya, general living conditions in Libya were much superior, on average, for the citizens of Libya in general, than in Saudi Arabia then, and even today.

But Libya has a lot of oil, and the British wanted to get rid of Qaddafi. They brought in a number of these well-trained terrorists, and Osama bin Laden, who was, by that time in 1989, already a wealthy merchant whose family owned one of the top construction firms in Saudi Arabia. In fact, the Binladen Group is one of the top companies in Saudi Arabia. Osama was handing out money to maintain his own group of people, who were preaching Wahhabism.

So Osama was brought into the fold by the British, and he was used in this project of getting rid of Qaddafi. A whole bunch of Libyan terrorists who were in Afghanistan fighting the Russians could not go back, because Qaddafi would have nothing to do with them either. And so the Brits recruited them, and through Osama's network, got them to participate in a plot to eliminate Qaddafi. With Osama's help, the British, who were masterminding the whole thing, tried to assassinate Qaddafi.

Although that plot failed in 1995, the British continued to hold onto their assets, and later, in 2011, they pumped them up again to achieve their objective. In 2011, the Brits got much larger support—in fact, the



Libya's Muammar Qaddafi, although he certainly had his flaws, was improving living conditions in his country and was independent of the British and the Saudis. So they got rid of him.

whole Western world's support—to get rid of Qaddafi. So the old project was back, and the terrorists were sent in.

The Saudi Angle

Now, these terrorists, who were trained and armed in Afghanistan—a large part of their funding was done by the Arab monarchies. Britain never funded them. The British always laid down the policy, laid down the design, structured the plots, sheltered and harbored the terrorists, but the money was always coming from Arabia. Saudi Arabia has always been the largest donor in this whole business, and some money came from the Kuwaitis, and to a certain extent, from Qataris and others.

But the Saudis always had an angle to all this. This angle of the House of Saud was always to propagate, through violent means, their extreme orthodox form of Islam. Their form of Sunni religion—Wahhabism, accepted by a small sect, compared to the overall Sunni population in the Islamic world—was pushed with the intent of getting control over the Islamic world. And therefore, these terrorists were also indoctrinated with the Wahhabi form of religion, the most virulent form of Sunni orthodox religion. After the Soviet Union collapsed, a large number of these Wahhabis were pushed into Central Asia—into Tajikistan, Kyrgyzstan, Kazakstan, and Uzbekistan, in particular, the four newly formed nations that had been part of the erstwhile Soviet Union.

Now, the problem was that these Central Asian countries are extremely poor. The Saudis used their money to print thousands of Qurans in Pakistan. Pakistan has air service to Tashkent and Dushanbe in Tajikistan—and they used these air services to load cratefuls of the Saudi version of the Quran to these countries, and distribute them. These Wahhabis, many of whom were trained by the Britain-headquartered Hizb ut-Tahrir, opened up free food centers, and recruited locals, the way evangelical missionaries do in many poor countries. Also, at the same time, some of those Wahhabi evangelists were terrorists who were recruiting people

to arm them against their respective governments. It was easy. Because of the dire poverty, people were disgruntled, and these locals were organized into terrorist groups.

There are two or three big terrorist groups that now operate in Central Asia, whose objective is to unseat all the Central Asian heads of state who were previously part of the Soviet Union. These Central Asian heads of states are secular, they have very little connection to the religious institutions, although they are all Muslims. They never became 100% Communists, and they remained secular and tolerant of all varieties of Islam.

And so, in Central Asia, terrorists, who seek regime change in order to establish Wahhabi-controlled states under a Caliphate, were run top-down by the Saudis, using their money, and the British-controlled terrorists. The British interest is very clear. I think, even at the time the Soviet Union collapsed, the financial system run from the City of London and elsewhere was going down the drain. The Brits realized that their financial system could not be kept alive.

In order to extend this dying financial system's life, they did a couple of things. One was to enhance the generation of money through drugs. Drugs were one of the major sources of money that was created through the Afghan War after the U.S. and NATO invaded Afghanistan; the other measure they undertook was, of course, to unleash the the old colonial interest to grab resources. In Libya, for instance, if you look at the Libyan oil, the Chinese were investing quite heavily in exploiting Libyan oil, but the invasion of Libya uprooted the Chinese base from there, so, China lost about \$2-3 billion. The British and the French took over.

The ongoing Afghan War, possibly, could also end in the same way. There will be efforts to make a grab for the Central Asian oil and gas so that it cannot go northward towards Russia, but travel southward, and possibly toward Europe. This is in the plans—the southern corridor.

So there is an element of resource-grabbing, the old colonial interests that exist in all of this.

The 'Arab Spring'

Now, 9/11 [2001], basically was organized in such a way that the American geopolitical interest, after the Soviet Union collapsed, got completely enmeshed with the British colonial geopolitical interest, which was historically run in Arabia by the Saudis and a few others, the Emirates and Qatar.

This has now taken the form of what some call the "Arab Spring." This Arab Spring is basically to create total chaos in the Arab world. Such chaos has all the potential to break into a full-fledged global thermonuclear war.

One added element to that, is that Iran, the country which is on the outside of all this, is considered as enemy number one by all these forces, including the U.S., the U.K., and the House of Saud. So, this Iran element is another factor that has created the threat of a global thermonuclear war. The view of these forces is that the Soviet Union is gone, but there exists another dangerous enemy in the area, which is Iran.

Now, the House of Saud's operation, its *modus operandi*—and I have followed closely that process in the Indian Subcontinent, and even beyond the Subcontinent, in its neighborhood—is basically to undermine the local Muslim population. In India, and in Pakistan, even today, despite all the things you hear about Pakistan, about 60-65% of Muslims, who are Pakistani citizens, are Sunnis, but they are of a moderate variety. They are Sunnis, and they identify themselves as the Barelvis. This variety of Sunni theology was born in a place called Bareilly, which is now part of India; and I think not more than 20-25% of the Muslims in Pakistan are Sunnis of the orthodox variety. They are known as Deobandis. Their theology is pretty close to the Wahhabi variety, but not quite the same. And then, another 10 or 15% of Pakistani Muslims are Shi'as.

Now, the House of Saud's operation to control these areas is, first, the terrorists who were created in Afghanistan, were indoctrinated with the Wahhabi version of religion. So, they went about undermining the Barelvi faction within Pakistan: threatening them, killing them, and all that. It is, as Hussein Askary pointed out, not a Sunni-Shi'a issue: Sunnis are killing each other. Wahhabis kill anybody and everybody. And in fact, in one of my articles,¹ I wrote that one of the things that the Wahhabis had pointed out to the British, was their uniqueness: They kill them all; they don't discriminate. Whether one is a Jew, or a Christian, or a Shi'a, or a non-Wahhabi Sunni—whatever the person's religious affiliation may be, they kill them all! So, that is the Wahhabi version that the House of Saud stands for, and they have promoted it wherever Muslims exist, even in places like Sri Lanka, where

1. Ramtanu Maitra, "The House of Saud: British-Programmed Killer of Muslims," and "What Is Wahhabism?," *EIR*, Sept. 28, 2012.

the Muslims are a tiny minority.

Creating the Taliban: The Madrassas

And what is the most unfortunate thing in this, is that the House of Saud's version of Islam is being promoted by the people who are considered as Christians, considered as democrats, like the British, even the Americans. In recent years, I have seen in Sri Lanka—the Muslim minority there is pretty moderate in their views, but there was the “fear,” quote/un-

quote, of the Americans, that the Iranians would have an impact on those Muslims. So, before such a thing could happen, the Brits and Americans brought in the Wahhabis. The House of Saud is now pumping large sums of money in to create madrassas, which are schools for the young, to teach them their extreme orthodox variety of Islam. So, a number of these madrassas, as they are called, have been set up in Sri Lanka.

This was also the foundation on which extremism in Pakistan was created. These madrassas were the basic sources where, in the late 1990s, the Taliban forces in Afghanistan were born. The students in Pakistan were indoctrinated with this ideology, and then they were sent to Afghanistan, with the help of the Pakistan military at the time, to take control of Afghanistan, which had had many varieties of Sunnis and non-Sunnis. But, importantly, the Afghans are not extremists, they didn't want Afghanistan to be a religious nation! They wanted Afghanistan to be just like Afghanistan of the good old days. But these Taliban took control with the help of Saudi money. And Saudi money also went to the Pakistan military, which always needed money, and to the madrassas that they created. These three forces together created the Taliban.

The basic concept of creating these Taliban in Afghanistan was to create an outpost of the House of Saud's Wahhabi followers on the threshold of Russia, next door to Central Asia, and inside the belly of the Indian Subcontinent. The purpose was to use these Wahhabis to expand their control, and threaten Iran, which is located south and west of Afghanistan.



The VJMovement

A madrassa (religious school) in Pakistan. The House of Saud is pumping large sums for the creation of extreme orthodox training centers in Pakistan and Afghanistan. This is how the Taliban was created.

This is a project which is washed with blood; but at the same time, it has all the basic ingredients that can lead to a war. But, again, it is to be noted that the funding of this thing is not done entirely with Saudi oil money, but much of the money needed for this project is generated through production of opium and heroin. Money generated by huge amounts of opium and heroin then gets laundered through offshore banks. Note: 90% of these offshore banks are located in former British colonies. And all that dirty money that came out of killing youths, ends up in the City of London and the Wall Street.

So, basically, what we are saying is, that this role of the House of Saud, working hand-in-glove with the British Empire, was endorsed by the Bush-Cheney crowd, and is now being officially moved forward by the Obama Administration. That's what they're doing. They are pushing this Libya thing, and then the Syria killings. You never know how wide-ranging this conflict may turn out to be. I mean, Lebanon is on the verge of collapse at this point in time. Jordan is teetering on the brink, and so is Kuwait.

Now, of course, two of these countries are monarchies and these monarchies, of course, will collapse. One may think that's not a very bad thing to happen, but on the other hand, it will be, because the people who are removing the monarchies, are also being controlled by the House of Saud and the British Empire!

Therefore, the danger that we see threatens the world is increasing with all these terrorist-run operations.

The House of Saud: Built on Sand

Having said that, I must also point out that the House of Saud itself is also in great trouble. Great trouble in the sense that it was never very stable to begin with. Abdul Aziz's seven sons, who are known as the Sudairies, are now vanishing from the scene. The last one is Salman, who I think is the Crown Prince, and is reportedly suffering from some sort of terminal disease; and King Abdullah, who is not one of the Sudairies, but had to make peace with the Sudairies, is now 94 years old, and most of the time he spends in ICU. When he is gone, then the next generation will come in, and some of the claimants to the throne from the next generation are very, very militant. It is a certainty that that they will fight among themselves for the Saudi throne.

At the same time, this will be a fight in which there will be no public support. The people in Saudi Arabia, in general, have long been deeply angered by the rule of the House of Saud, not because of what the House of Saud does outside, but what it does inside Saudi Arabia itself.

So, what we see here, is that a dangerous force like the House of Saud, with the British controlling this family, has brought about a total disaster to the entire world, and has now brought the world to the threat of another global war, but this time, it could be a thermo-nuclear war.

This is the story of the Two Kingdoms, this is what they have done. Unfortunately, the American republic has been compromised, and the Bush-Cheney, and then the Obama Administration, in particular, have completely joined hands with these two vicious kingdoms, who are involved only in bloodshed, and in creating chaos in order to loot and plunder, and keeping the world on the brink of another war.

Askary: Because of all that has been said, I think that the investigation of 9/11/2001—the first 9/11—could be the drop which could get the bucket to overflow on the British Empire and the Anglo-Saudi Empire. Because, there in the classified 28 pages of the report of the 9/11 Commission, you have the whole story of the BAE (formerly British Aerospace Systems), which is now the world's largest arms and intelligence company, which is the real core, besides the financial City of London, of the British Empire and the Anglo-Saudi Empire.

And therefore, both the Bush Administration and the Obama Administration were so desperate to hide

the truth about the BAE/Prince Bandar bin Sultan involvement in the first 9/11 events. And that's why we hope that people in the United States will pull the carpet out from under the feet of these imperialists. And whether by getting rid of Obama, or whoever comes after Obama, the truth about 9/11 should come out; but not in the sense of who did what immediately there, but the whole story. Because that can then bring to the fore this whole historical background we have discussed, and show what the forces are which humanity has to get rid of, to have a better future.

And of course, then, the other step is to get a new economic world order, a new financial and banking system, getting the Glass-Steagall banking act into place, getting credit to infrastructure, economic development nationally and internationally. And people in Asia, in Russia, China, and Africa, are all ready to go ahead with a global Marshall Plan, or New Deal. And that will help us get rid of this religious fanaticism.

Against the Islamic Renaissance

Now, just to briefly demystify what this Wahhabi cult is, what the teachings are: It's not a new phenomenon. It was a reaction to the Islamic Renaissance of the Eighth and Ninth Centuries, which was a real Renaissance movement, which had established a fantastic economic, cultural, scientific basis for civilization in Baghdad, and also in Spain.

And the attack came from within the Islamic world, but was also part of a political conflict in the 10th and 11th Centuries, when the Seljuk Turks, who were military officers, were incorporated into the Islamic armies. In order to take over, they had to destroy this idea of the Renaissance, which is based on two very important aspects of the Islamic religion, and all other religions. The whole conflict was about, first, the free will of the individual; and second, creativity. Does the human being have free will in doing what we need to do, and to be creative? And, what is said in Islam? That we should help build the world, the Earth, make the Earth flourish. Do we have free will? Or is everything decided by the will of God, which is that everything is predestined?

And does the creative human being have any connection to the Creator? Or is the individual human being totally separated from God the Creator?

Now, in the Islamic Renaissance, these ideas were being explored. People like al-Farabi, ibn Sina, and al-Razi, were arguing, in the sense that human beings *do* have free will to do the Good, and they are creative, and



Wikimedia/Commons

The creation of the Wahhabi cult was a reaction to the Islam Renaissance. The magnificent Mosque of Cordoba, in Andalusia, Spain (left) was begun in 784 B.C. On the right is the Alhambra Palace in Granada, Spain.



EIRNS/Stuart Lewis

they participate in the creativity of our Creator, by their acts of creativity and free will, by building the world, and getting scientific knowledge, and ennobling the human soul through culture, music, poetry, art, and so on and so forth—architecture. That was the basis of the Islamic Renaissance.

But then you had this reaction: It started with al-Ash'ari and al-Ghazali (see box), who negated all the principles of free will and creativity, and the connection to the Creator. And then you had ibn Taymiyah, coming after the Mongols destroyed Baghdad; and then the Crusades, which were a Venetian operation. And then ibn Taymiyah, who is the source of the Wahhabi doctrine, abolished all previous Islamic doctrines, including the four main Sunni sects, the Maliki, Hanafi,

Shafi'i, and Hanbali. Most Sunnis in the world follow one of these four; and then you have the Shi'a, who have lived actually in coexistence with the Sunnis. But the Wahhabis abolished all these previous ones, and they say, we will have a pure theology, which is based solely on the words in the Quran, and imitating some of people they select, who were around the Prophet Mohammed (God's blessings be upon him).

They are very, very selective in choosing the Prophet's tradition and the word of the Quran, which they interpret literally; there is no room for interpretation. And that way the Wahhabis became a tool to declare everyone who is not following their military force, or political force, a heretic.

Maitra: This is shutting down the *ijtihad*.

Askary: Exactly. You can have a free way of interpreting the word of the Quran or the tradition of the Prophet, and in that way religion becomes an evolving, developing way of thinking, rather than a rigid, fixed set of rules which cannot change, which is the core of the Wahhabi sect. Therefore, they come into conflict with everyone, everyone around them!

But the trick is, that the Wahhabis of the al-

Saud family today, are not religious! They even ended up killing some of the Wahhabis, in 1930, because the Wahhabi religious administrators were not happy with al-Saud [being so close to the British]. . .

Maitra: They are as religious as the House of Windsor is Christian.

Askary: Yes, exactly! But their power lies in their connection to the British Empire, and the enormous financial and military resources they can have, and also intelligence operations. So, that's where the danger is.

But as I said, from inside the United States, if we can get the truth about 9/11 and the coverup, then you can start exploring this whole story backward, into that the reality that the ones who attacked the United States republic were the British Empire and their Saudi pup-

pets. And that will set the world stage for abolishing empire, and re-establishing a community of sovereign nation-states working together to develop societies, the human individual, and the whole planet, and beyond

the planet.

Maitra: It will also, again, give a potential for starting a new Islamic Renaissance.

Askary: Exactly.

Wahhabism and Ash'arism

The highest Wahhabi religious personality in Saudi Arabia, the Mufti and Chairman of the Supreme Council of Ulama (clergy), Abdul-Aziz bin Abdullah Al-Asheikh, on March 12, described the acts of fund-raising and supporting the rebel Syrian Free Army as *jihad* under Islamic law, because, according to him, the Syrian regime is *kafir* (blasphemous or apostate). However, when it came to peaceful protests in Saudi Arabia by those demanding economic and political justice, these he declared to be evil.

This is a typical example of the selectiveness of the Wahhabi clergy, which always takes the side of the House of Saud. A former Mufti, Abdul Aziz bin Baz, was asked about Muslims wearing crosses and other ornaments; he declared it a sin. However, when he was asked about King Fahd wearing the Iron Cross of the British Empire, awarded to him by Queen Elizabeth II, making him an honorary British Knight in 1987, bin Baz replied that "if the Wali al-Amr (the ruler of Muslims) considers that wearing the cross has a benefit to the Muslim nation, then that cannot be considered an offense"!

This idea that the "ruler of the Muslim nation" cannot be faulted was an artificial creation of theologians who were used by Umayyad kings at the beginning of the Eighth Century to get immunity for oppressing the people and killing other Muslim opponents, to acquire and preserve power. They manipulated the following verses from the Quran as a blank check for their rule: "O you who have believed, obey Allah and obey the Messenger and those in authority among you" (Surah Al-Nisaa, verse 59).

One of the most vocal such theologians was **Abu Al-Hasan Al-Ash'ari** (875-935), the spearhead against the Islamic Renaissance. His concept was that Allah is the Creator of everything in existence, and so both evil and good acts of human beings are predestined by God's will. Therefore, the evil com-

mitted by the ruler is not his own creation, but that of God, and if people tried to change that evil, they would be committing a sin against God's will!

Al-Ash'ari, who started as student of the Mu'tazilites, turned against them in 912, and published his book *Clarification of the Bases of Religion*, in which he argued for absolutely literal interpretation of the Quran, in a clear attack on the Mu'tazilites, who were calling for a rational method of interpretation, because the divine injunctions of the Creator are accessible to human reason, and that reason must be the ultimate criterion for judging good and evil. The Mu'tazilites had become a strong philosophical and scientific school in the early Renaissance age in Basrah and Baghdad in the Eighth Century.

Al-Ash'ari attacked, for example, their view that God's references to his "seeing, hearing, having hands, 'sitting on the throne,' etc." were metaphors. He claimed that God does indeed have such physical attributes, because that is what is stated in the Quran.

As part of the Seljuk power grab in Baghdad, **Nizam-ul Mulk Al-Tusi** (1018-92), the Seljuk vizir (minister) under Sultan Alp Arslan, raised the Ash'arites to prominence in Baghdad to take over the Shafi'i Sunni sect, while undermining the other Sunni sects, creating sectarian strife in Baghdad. He established the Nizamiya school of theology, the institution from which a later theologian emerged, **Abu Hamid Al-Ghazali** (1111-58), who launched the final and most fatal attack on the science and philosophy of the Islamic Renaissance. His most famous book, *The Destruction of Philosophers*, is entirely oriented to destroying the philosophical thoughts of Ibn Sina (980-1037), the greatest of Muslim scientists and philosophers of the Islamic Renaissance, and his predecessor Al-Farabi. Al-Ghazali's inquisition became a tool of destruction of rational thinking, pushing society into mystical fundamentalism. The socially and economically weakened and divided Islamic state became an easy prey for the Venetian-run Crusades, and later, the Mongol invasion.

—Hussein Askary

LaRouche: Dump the Parties, Put Recovery Program in Now

Special to EIR

Oct. 30—In webcast statements on Oct. 26 and Oct. 29, Lyndon LaRouche hammered away at the revolution in political practice that has to be accomplished in the United States, if it, and the world, are to survive. First, the political party system which came into the United States with Andrew Jackson, and has produced the wretched choice of candidates now facing the American electorate Nov. 6, must be abandoned immediately. Secondly, the American population must be mobilized around the policies that will save the nation, specifically the three-point full-recovery program of Glass-Steagall, national banking, and the North American Water and Power Alliance (NAWAPA).

While sticking to his evaluation that the incumbent British tool Barack Obama must be removed from office, perhaps by impeachment for his high crimes and misdemeanors, LaRouche focussed on the broader systemic problem bedeviling U.S. politics. How did we get the point of being faced with two such disgusting choices for President; one, Obama, being a mass murderous danger to our immediate survival, and the other, Mitt Romney, being an advocate of an economic program which will decimate our population by other means? It's the partisan party system, which the British have played for more than a century. It must be dumped for politics of principle, as Presidents George Washington and John Quincy Adams, most famously, demanded.

The prospects for making that change are about equal to the chances for the United States to survive the coming financial and geopolitical storms.

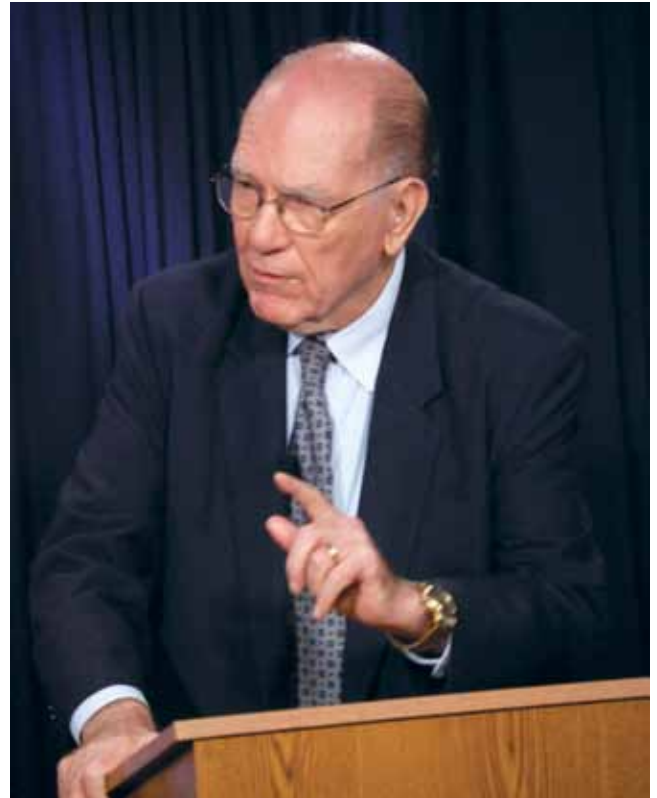

EIRNS/Stuart Lewis

Lyndon LaRouche gives his [webcast](#) on Oct. 26, the latest in a series of "Friday webcasts" leading up to Election Day on Nov. 6.

Hillary Must Turn Obama In

During the LaRouchePAC candidates' discussion on Oct. 29 (weekly at www.larouchepac.com/campaigns), LaRouche homed in on the potential that an

immediate move for impeachment of Obama had for shifting the agenda appropriately. The firestorm of revelations currently coming out about the Administration's criminal negligence in the Benghazi terror attack (see following article) creates an opportunity, even at this late hour.

The key to the solution, LaRouche said, is Secretary of State Hillary Clinton, who, according to recent leaks by sources close to the Clinton family, has direct evidence that Obama's White House was the entity responsible for denying necessary security to the Benghazi consulate, where Ambassador Stevens and three other Americans were killed by jihadis. Hillary Clinton must "turn Obama in, for the skunk, the traitor, the enemy of humanity which he is, and has manifested himself to be."

According to Ed Klein, author of *The Amateur*, a biography of President Obama, "the legal counsel to Clinton" told him that not only had the Secretary of State requested beefed-up security for the Benghazi consulate—as requested by personnel there—but Obama had denied the request. Speaking to The Blaze TV's Andrew Wilkow on Oct. 26, Klein said that his sources report that former President Bill Clinton has been urging his wife to release State Department documents that would prove that she ordered the beefed-up security presence; but she has so far declined to make them public, knowing that this would virtually assure Obama's defeat on Nov. 6.

But it's Hillary's *duty* to expose Obama, LaRouche insisted. "That would be the solution: Because what that would do, if she would do that, she would save the Democratic Party. Not let the Obama issue settle it, but let the downing of Obama settle it. Because once Obama is out, whoever frees the nation from slavery to this mass murderer, is going to catch the sympathy of the nation on a rational basis, not on a screwball basis of the type they make usually, now."

Clearing the Way

Once we get rid of Obama, LaRouche continued, we greatly diminish the danger of thermonuclear war. Just voting him out, without impeachment, is more dangerous—since his rage at rejection, as well as the crisis state of his British masters, would tend to propel him to take more rapid rash steps toward thermonuclear confrontation. Obama must be crippled politically, his authority over government destroyed by the impeachment process—or even the invocation of the 25th Amend-

ment to the Constitution, a measure long advocated by LaRouche based on the President's narcissistic personality disorder.

But once Obama is prevented from being a danger, LaRouche emphasized, "we can, in the United States, proceed to save our economy by the obvious reform, Glass-Steagall, and what has to go with Glass-Steagall as its supplements." Those supplements, outlined in LaRouchePAC's mass pamphlet "Program for a New Presidency," mean the restoration of a Federal credit system, built around a massive jobs-creation, reindustrializing program such as NAWAPA XXI, the huge Western U.S. water-diversion program that would create 6 to 14 million jobs.

Once Hillary Clinton took the steps to sink Obama, LaRouche said, that would provide a new perspective for the Democratic Party. "It would give us a not-so-good President, nominally, but the power of the Democratic Party, once it's cleaned of the Obama affliction, the people who step forward in leadership, to dump Obama for the sake of the nation, would be a powerful force of the Democratic Party, particularly, when presently the Republican Party has no commitment to saving the lives of endangered people.

"They're going with a 'business program,' a business-based program, which is a vicious kind of austerity which will have horrible effects, in any case, in its own right, on the people of the United States! And at that point, if you can mobilize the Democrats, even after a Republican has been elected, if you can mobilize the Democrats, or a good part of them, to come out from under the ether, by an action which is considered an act of salvation of the nation, then, we will have the basis for *destroying the party system*."

The present party system, LaRouche went on to say, is what allows the British Empire to play people against each other, and destroy the nation—just as, in another venue, the Roman emperors got people to cheer for killing each other in the Colosseum. The British have *consciously* done this, he said—and we have to put a stop to it.

"This time, we've just got to do it," LaRouche concluded. "I think we're right on it: Hillary Clinton has much more power for humanity than she probably imagines. If she dumps Obama, just by saying what the truth is about what happened in Benghazi, that would make her a hero, it would get rid of Obama, and it would enable us to *dump* the party system! And then, we're ready to go!"

Benghazi Lies Blow Up In Obama's Face

by Jeffrey Steinberg

Oct. 29—New revelations about President Obama's coverup of his administration's failures to protect American diplomats prior to and during the Sept. 11, 2012 assault on the U.S. consulate in Benghazi, Libya, in which Amb. Chris Stevens and three other American officials were killed, are blowing up in the President's face on the eve of the Nov. 6 elections.

Last week, three e-mails, sent from the U.S. Embassy in Tripoli, as the assault on the consulate was underway, were made public by Reuters. Those three documents, which were sent to the White House Situation Room, the Director of National Intelligence, the Director of the CIA, the FBI, and numerous officials at the State Department, made clear that the attack on the consulate was a well-planned and heavily armed assault. In none of the diplomatic messages was there any mention of a demonstration outside the Benghazi consulate. In the third of the e-mails, the group Ansar al-Sharia was identified by name as taking credit for the attack, and calling for a similar assault on the U.S. Embassy in Tripoli.

Now, in the past 48 hours, a series of damning additional leaks from within the U.S. military indicate that there were rapid-reaction forces ready to intervene into the Benghazi events as they were still unfolding, but that no authorization came from Washington. According to Lt. Col. Anthony Schaffer (ret.), top officials of the Obama Administration, including the President himself, were monitoring the events in Benghazi in real

time, through drone surveillance relays back to Washington. Yet, special units attached to Africom, and even CIA paramilitary teams on the ground in Benghazi, were ordered to stand down, when they asked for authorization to launch air strikes against mortar positions firing at the consulate.

According to a news report aired on Fox TV and several other conservative news outlets, Africom commander Gen. Carter F. Ham was temporarily relieved of his command when he refused to accept the orders to call off the deployment of C-130 gunships to the scene. And a replacement for him has already been named, even though he is less than two years into what is normally a three-year tour.

What Did He Know, and When?

To date, President Obama has refused to provide any details about when he learned of the ongoing attacks, what he did about it, and why. It is known that the President was at the White House at 4:05 p.m. on the afternoon of Sept. 11, 2012, when the first e-mail arrived from Tripoli. At 5 p.m., he met with Defense Secretary Leon Panetta and Vice President Joseph Biden. No further details of what the President did on Sept. 11, 2012 have been made public by the White House or by the President's re-election campaign.



White House/Pete Souza

President Obama repeatedly lied to the American people about the terrorist attack in Benghazi, including on the David Letterman Show, seen here.

On the morning of Sept. 12, the President spoke briefly to the media in the Rose Garden, but did not characterize the Benghazi attack as an act of terrorism, contrary to what he himself claimed in the second Presidential debate with Gov. Mitt Romney. Later in the day, the President went to the State Department briefly, and then flew to Las Vegas for a campaign fundraiser. There is no indication that the President convened the National Security Council or took any other action appropriate under the circumstances of an attack on an American diplomatic outpost.

Senior U.S. intelligence sources have told *EIR* that the President and his campaign team panicked over the Benghazi attack, because the President had been campaigning non-stop around the idea that he had destroyed al-Qaeda by killing Osama bin Laden, and by the drone and special forces assassination program. The Benghazi incident made clear that al-Qaeda and its affiliates were very much alive and on the offensive.

When UN Ambassador Susan Rice went on national television on Sept. 16, and when the President appeared on the David Letterman Show and *The View* days later, they both lied to the American people, claiming they did not have enough information to declare the Beng-

hazi attack an act of terrorism. In reality, as the three 9/11 e-mails make clear, the evidence was overwhelming that an al-Qaeda-affiliated group, led by a former Guantanamo Bay detainee, had killed the ambassador and three other Americans.

EIR's intelligence sources have further reported that the Obama White House and top national security cabinet officials are furious and panicked over the fact that new details are being leaked to Members of Congress and the media, further exposing both the incompetence and the lying coverup by top officials, perhaps including the President himself. According to the sources, military officers who were in a position to send emergency teams into Benghazi are furious at the runaround they got in Washington, and are leaking to the media and Congress.

A number of Congressional Republicans have demanded specific answers from the President, including a detailed account of his actions on Sept. 11, 2012. Sen. Ron Johnson (R-Wisc.), appearing on Fox TV this morning, told host Chris Wallace that the Benghazi attack and its aftermath are the number one issue on the minds of voters in his state, and that the President must come clean on what happened.

LaRouchePAC Special Report

NAWAPA XXI

A North American Water & Power Alliance For the 21st Century

FROM THE AUTHORS:

This report is written as a proposal for action, to be immediately undertaken by elected officials of government; and as a handbook for patriots who seek to re-establish the United States as a leader in science, technology, and industry.

IN THIS REPORT, YOU WILL FIND A PLAN TO:

- **Employ millions in productive labor and restore U.S. manufacturing.**
- **Re-establish water, food, and power security for North America, establish a continental system of drought and flood control, and develop new infrastructure corridors involving most of the continent.**
- **Restore the U.S. system of public credit.**
- **Demonstrate man's ability to improve on nature.**

ORDER ONLINE: www.larouchepac.com



Brzezinski: Don't Back Syrian Rebels

by EIR Staff

Oct. 27—Zbigniew Brzezinski, the former anti-Soviet hawk who, as Carter Administration National Security Advisor (1977-81), helped create the rebel mujahideen in Afghanistan, has vehemently rejected any proposal for arming rebels in Syria. Speaking on PBS's Charlie Rose Show Oct. 23, the former Trilateral Commission operative denounced the British and French for creating the "mess" in Syria, and spoke of working with Russia and China to find solutions to the region's conflicts. The alternative, he said, will be regional war.

In a webcast last night, Lyndon LaRouche assessed Brzezinski's radical turnabout, saying, "He now looks at the world and says 'Look, that time is over. There no longer is a Soviet Union to worry about. There are no longer these other kinds of things. I am an old man; I am a Catholic; I'm a devoted Christian. And in my time, as I'm reaching a terminal state in my life, what am I going to do with the remainder of my life?' And, therefore, you have the case where someone who has acted like a reprobate from the standpoint of looking in from the outside, and you find that they're coming out with a completely different policy. It's their own policy, for a change. An old man who's not going to go out of this world without taking some honor with him."

Rose's program was on the theme of a recent paper by National War College Prof. Michael Mazarr, that the current U.S. strategic posture is unsustainable. Mazarr was also a guest on the show, along with former Obama National Security Advisor Gen. James Jones and *Washington Post* columnist David Ignatius.

Host Rose asked Brzezinski how "strategic unsustainability" applied to Syria. He replied that we must consider, "What are the prospects, perhaps, of that war rapidly spreading. Syria is next door to Iraq. Iraq is on the verge of a breakdown between the Sunnis and the Shi'ites, into a civil war. Syria is also on the brink, on the edge, of the Kurds, and their role in the region. It could be very, very destabilizing, if the war started spreading. There is, of course, Iran next door, which could become in some fashion involved.



CSIS

Zbigniew Brzezinski, never known as a peacenik, warned in the strongest terms, on the Charlie Rose show, that a U.S. attack on Iran or Syria would be a disaster; instead, he urged, we should be working with the Russians and the Chinese, to bring stability to the region.

"In brief, I have the feeling that it's not exactly within the realm of our means, of our resources, or compatible with our recent experience, to enter the fray, without thinking very seriously about the likelihood that if we enter into it, particularly if *we* enter into it—because we're not exactly popular in the Middle East these days—the result will be a much *wider* war, with really serious consequences then for Turkey, and perhaps for Jordan and Saudi Arabia, and because of its economic consequences, for Europe. So I'm afraid that the word I tend to emphasize in this context is 'prudence,' rather than 'engagement.'"

Rose began a description of the Presidential candidates' debate remarks about the various ways they thought they might aid the Syrian opposition, and Brzezinski interrupted, "You can't start supplying arms to someone, without becoming engaged in the consequences of that! You can't maintain that kind of sealed detachment from the supply of arms, and eventually, engagement in the process. Especially if the supply of arms *itself* creates temptations to spread that war."

Later in the show, Mazarr described how the Obama regime is groping toward a Syria policy in the new paradigm, potentially arming opposition groups, and a variety of similar steps, "but they're going to be very messy, and they're not going to satisfy a lot of advocates of

short-term action, and we're going to have to keep at them for a long period of time. It's not going to be as *clean* as advocates of intervention had once thought."

An Extremely Volatile Region

Rose, off camera, asked: "Zbig, you're smiling as you heard him say that. What does that smile mean?"

The camera shifted to Brzezinski, who chuckled, and smiling broadly, responded, "Well, I just don't understand how we can get involved in supporting and arming, and thus intensifying, the makings of a civil war, without thinking as to how long it may last, how much blood will it consume, how deeply we'll have to become engaged, and how it might spread. *This is an extremely volatile region.* You have to think of it, not just as Syria, which is more than 20 million people. Yes, 30,000 have been killed, but it's 20 million people, and most of the 20 million people are still controlled by the government. So we're going to try to overthrow that. So we're going to make that civil war more intense, more extensive, more bloody.

"And, it will affect the neighborhood, because it will ignite the Sunni-Shi'ite conflict. It will destabilize Jordan. It's already destabilizing Lebanon. It might draw in the Turks. Are the Turks prepared to lunge into Syria? Maybe they would like *us* to clean up Syria, but we have to ask ourselves about the consequences if we try. Are we prepared to do it *seriously*, or are we just going to provide arms, as it progressively gets worse? I think after ten years in Afghanistan, after the mess in Iraq, we'd better think calmly and coldly about this issue. It's very emotionalizing, because there's a lot of human suffering involved. But I would like someone to lay out a blueprint for how this problem is to be solved by us, starting first with arming the opposition—but excluding an eventual massive involvement? And with the region exploding?"

Work with Russia, China

To Rose's question, "So, we do nothing?" Brzezinski said there are a lot of other things we can do, and advocated working with the Russians and Chinese to develop a viable solution to be presented to the Assad government as something workable—rather than dictating to it our ideas, and then denouncing Syria's refusal to accept them.

He added, "I'm saying, let's see if we can still do it with the international community with us. And I think that having the Russians and the Chinese [work with

us] is not yet to be excluded. *We can't really rely on the advice of the French and the British, because they are the architects of the mess that is now beginning to collapse*" (emphasis added). Rose hastened, as Brzezinski was finishing that last sentence, to shift the discussion.

Near the end of the program, Brzezinski reiterated the danger of triggering a regional war:

"There are two powers next to Syria, who are very important, and very relevant to the future of what happens. One is Saudi Arabia. We have to be very careful about that, because the Saudis are deeply involved right now, in fanning a Sunni-Shi'ite conflict in Syria. Is that really in our interest? Are we really supposed to be supporting that? And how will this impact on the Iranian reaction? That's something which I think warrants some caution.

"The second one is Turkey. Turkey is an important 80-million country: 80 million people. It has the best army in NATO, outside of the United States, actually. What about the Turks? You're going to have an American involvement in arming the rebels, and potentially an American engagement in the conflict?"

DOPE, INC.

Is Back In Print!

Dope, Inc., first commissioned by Lyndon LaRouche, and the underground bestseller since 1978, is back in print for the first time since 1992. The 320-page paperback, includes reprints from the third edition, and in-depth studies from *EIR*, analyzing the scope and size of the international illegal drug-trafficking empire known as Dope, Inc., including its latest incarnation in the drug wars being waged out of, and against Russia and Europe today.



*This edition, published by Progressive Independent Media, is currently available in limited numbers, so there is no time to waste in buying yours today. The cost is \$25 per book, with \$4 for shipping and handling. It is available through www.larouchepub.com, and *EIR*, at 1-800-278-3135.*

Down to the Wire To Restore The Glass-Steagall Principle

by Nancy Spannaus

Oct. 30—A testament to the fraud that is the U.S. Presidential election campaign, is the fact that the bankruptcy of the North Atlantic financial system, and the growing movement for reimposing Glass-Steagall regulations, have not even been mentioned in the official debates and campaign ads. Like the overriding issue of the British-Obama drive toward thermonuclear confrontation with the Russians, the restoration of FDR's Glass-Steagall principle is a matter of life-or-death for the American population. And it stands within the core of principled issues required for a non-partisan U.S. Presidency to rebuild the economy.

As shown by the fight waged by Senators Maria Cantwell (D-Wash.) and John McCain (R-Ariz.) back in 2010, the Glass-Steagall dictate for strict separation of commercial and investment banking, with its de facto denial of bailouts to the investment banks, is a bipartisan cause, and a highly popular one at that. Over the Summer of 2012, top bankers who had previously fought to overturn Glass-Steagall, including members of the London elite, also joined the campaign to restore Glass-Steagall, making it clear that the refusal to do so was creating the danger of a new, even more devastating financial blowout in the trans-Atlantic economy. Eighty-two Congressmen, including a number of Republicans, have signed on to Rep. Marcy Kaptur's (D-Ohio) HR 1489, which would reimpose banking separation.

Up until last week, however, the Presidential candidates remained silent on the issue.

Then, on Oct. 25, *Rolling Stone* published an interview of President Obama with reporter Matt Taibbi, who asked the President about banking reform, and the Dodd-Frank bill. Obama replied by defending his bill, and noting that *Rolling Stone* had previously criticized him for not going with Glass-Steagall. He said:

“But there is not evidence that having Glass-Steagall in place would somehow change the dynamic. Lehman Brothers wasn't a commercial bank, it was an investment bank. AIG wasn't an FDIC-insured bank, it was an insurance institution [both banks were allowed to go bankrupt—ed]. So the problem in today's financial sector can't be solved by re-imposing models that were created in the 1930s.”

So, for the first time publicly, Obama rejected Glass-Steagall. Romney headquarters, contacted by this news service for the Republican candidate's view, did not respond by deadline.

Obama's Lying

Obama's argument for rejecting Glass-Steagall is a popular, and a lying one, as exposed by one of the leading banker proponents for its restoration, former Kansas Federal Reserve president Thomas Hoenig. In an interview with Bloomberg radio June 26, Hoenig explicitly answered the charge that the mixture of the commercial and investment banking did not cause the blowout of 2007-08, but that mortgage companies, investment houses, and insurance companies did. Hoenig responded:

“Well, remember now, you’re talking about the end. If you think about it, though, the commercial banks, while they may not have originated some of the derivatives, but many of them, the bank holding companies that they were part of, did—credit default swaps, CDOs—they sponsored the institutions and then they gave lines of credit to those very groups that they had sponsored for derivatives activity. That ended up coming back on their books, so, yeah, they were part of the problem. They did encourage the risk-taking, by mixing their banking activities with investment activities, there’s no question about it.

“Now, on the other side of it, that’s why I say, you have to also address money markets and repos, because, yes, the Bear Stearns, the Lehmans, were acting like commercial banks. They were issuing very short-term liabilities, overnight repos and money markets, and then funding long-term assets, real estate activities, CDOs, and so forth, putting that in their book, and that, in fact, exploded on them.

“So, it was part of the problem of ending Glass-Steagall, separating out, then allowing, these shadow banks through money markets to arise that caused the problem. So they all are linked, and we can’t forget that.

“So I don’t think saying that they weren’t the source of the problem, that is, commercial banks weren’t the source of the problem, is accurate at all.”

The second fraud of Obama’s comment, of course, comes in on the other end—the bailout. No matter who or what caused the crisis, if Glass-Steagall were in effect, the Federal government would *not* back up and bail out the gamblers, like Lehman and AIG. And the health of the banking system would be the better for it.

But as the LPAC [documentary](#), “Indictment of Barack Obama: Part Two,” shows, Obama is dead-set against cutting the gambling banks loose. He opposes Glass-Steagall because it will hurt his financial controllers.

Some Republicans Will Move

On the contrary, the motion for Glass-Steagall among some banking layers, ranging from the Bank of England to independent community bankers in the United States, is continuing to grow. As former Fed chief Hoenig, now a commissioner on the FDIC, has said recently, the danger of the financial blowout is growing along with the galloping hyperinflationary bailouts—and only reimposing Glass-Steagall can begin to stem disaster.

Former Reagan Treasury Secretary and Secretary of State under George H.W. Bush, James Baker III, was the latest prominent Republican to express his support for reinstating Glass-Steagall. Following a Baker’s speech on “Civil Discourse and the Grand Bargain,” Oct. 23, *EIR*’s Bill Jones asked him about whether Glass-Steagall wasn’t the kind of issue “around which Democrats and Republicans could be brought together, perhaps under a Romney Administration, in order to begin to put the economy back on track?”

The moderator, Woodrow Wilson Center president and former Rep. Jane Harman, asked Jones, “Why don’t you tell people what Glass-Steagall is?” Baker replied, “It would separate the commercial banks from the investment banks.” Jones added, “This would relieve the commercial banks of all the debt piled upon them when the investment banks moved in on them, and would save the commercial banking sector which provides the life-blood to our industries.”

Baker then added, “What it said was that if you are in investment banking, you cannot do commercial banking, and vice versa. I don’t think that Romney would be in favor of Glass-Steagall. But reinstating it would be a great idea. When I was Treasury Secretary, we worked under Glass-Steagall. Too big to fail is still with us today, and taxpayers may again be called upon to foot the bill. I would very much like to see a reinstatement of Glass-Steagall. . . .”

James Baker III is a very senior member of the Republican establishment, but he is not optimistic.

Would Romney support Glass-Steagall? It is true that his chosen running mate, the otherwise rabid budget-cutter Paul Ryan responded affirmatively to an interviewer last November, on whether he would support Glass-Steagall banking separation, and Ryan has railed against Dodd-Frank and bailouts. However, he admitted to “setting aside his principles” in voting *for* TARP, and was one of those who voted to repeal Glass-Steagall in 1999. And he has not signed on to HR 1489.

The issue is coming down to the wire, not because of the election, but because of the reality of the global economic blowout. International support for Glass-Steagall is growing, for example, in Iceland, where a bill has been introduced in the parliament. But the lead has to be taken in the United States, still implicitly the world’s leading economy. And that means the next Presidency must be brought on line for Glass-Steagall, and American patriots, in or out of government, have to make it happen.

European Court Hears Pringle's Challenge

by Claudio Celani

Oct. 29—On Oct. 23 the European Court of Justice in Luxemburg heard the case of Irish Dáil (parliament) member (TD) Thomas Pringle against the permanent bailout fund known as the European Stability Mechanism (ESM), following the decision of the Supreme Court of Ireland to refer Pringle's constitutional challenge to it. The judgment is expected by the end of the year.

The proceeding took place as Europe confronted a social explosion, with the entire euro system about to blow. Germany's Merkel government is rushing to hand over sovereignty to the Brussels bureaucracy, as the people of Greece, Spain, Italy, Portugal, and others, face life-threatening austerity and economic degradation, in an effort to appease "the markets."

Last April, Sinn Féin president Gerry Adams launched his party's "No" vote drive, in the lead-up to the May referendum in Ireland on the ESM and the Fiscal Compact.

"The choice is between austerity, and economic stimulus and growth," Adams said then. "The choice is between us handing over powers to unelected officials and bureaucrats in the European Commission and in the European Court of Justice, and allowing them to run this state, and to police fiscal as well as monetary matters. Or we can vote 'No' to this, and assert the right of citizens to elect or sack our governments; and for citizens to have democratic authority over those who govern us."

While the May 30 referendum passed, in mid-April Dáil Member (TD) Thomas Pringle (Independent) announced that he had begun legal proceedings challenging the government on fundamental aspects of the EU treaties.

Pringle's argument is that the ESM operates outside of EU law, and that the change of Article 136 of the European Treaty, which enables the ESM to override Europe's "no bailout" clause, was not properly enacted. This case was made by Pringle's attorney before the

entire European Court, at which, for the first time, all the justices attended.

The plaintiff accused the European Union of twisting and subverting its own law. European law forbids the bailouts of states, but now we have a permanent bailout fund, he said. To justify this, a sophism was introduced, i.e., that the ESM is outside of EU law—a treaty among individual states. But European law says that financial policy must be coordinated within the EU legal order. The attorney also touched on the disruptive function of the ESM through its liquidity injections.

Against the plaintiff, the EU put on a show of force, deploying representatives of each and every member country, plus the European Council and the European Parliament. Each of them spoke, repeating all the same arguments, eventually letting the cat out of the bag. The German representative said: You must put this into the broader context. If the legal legitimacy of the ESM is openly challenged, this will upset the markets, and it will be the end of the euro.

In an interview with *EIR* (see below), Pringle exposed the ESM as a fund to bail out the banks. "I think it's obvious, that it's for the banks. And that it's for making the Irish bailout, a bailout right across Europe, where citizens become responsible for the banking debts, debts that they are not responsible for accruing, but citizens will be responsible for in the future."

Asked if he would support a Glass-Steagall-style separation of the banks, he said, "We have to make the banks responsible for their own debts."

Interview: Thomas Pringle

Governments Exist for Citizens, Not Banks

EIR's Claudio Celani interviewed Independent Irish Dáil (parliament) member (TD) Thomas Pringle, in Luxembourg, on Oct. 23, 2012.

Claudio Celani: Mr. Pringle, we heard today, here in Luxembourg at the European Court of Justice, your arguments against the ESM, the European bailout fund. Your attorney basically said that the ESM vio-

lates European law itself. Then we heard arguments from more than a dozen representatives of member nations, the European Parliament, the European Union, etc., and it's not over yet; we are on a break. Can you tell me if you found convincing arguments from your opponents?

Thomas Pringle: I suppose, in a word: No. It's very interesting listening to submissions from the other member states. Obviously, they were all party to the decision that established the ESM, so they have to defend their position.

It's interesting what they haven't addressed, rather than what they have addressed. In none of the submissions, have they addressed how the treaties could have actually been amended to make this possible. And I always have argued that that could have been done. Obviously, they took a decision, for whatever reason, not to do that and to establish this ESM outside the control of the [European] Union. And it's interesting, I think, that none of them has addressed what could have been done. And they say that it is the only option they had, while we have always argued that they had others.

Celani: Yes, we heard also some arguments which went into political contents, for example, the German representative, but also other representatives. He said that we must put this discussion in context, so he made it political. And he said, basically, that if there are doubts cast on the legality of the ESM, this would upset the markets, and this would be the doom of the euro and of Europe. Do you think this is a scare tactic?

Pringle: Well, obviously, because the decision to establish this ESM was taken in October 2010, over two years ago. And we know how the so-called markets have reacted all during that period. We couldn't have had any more instability than we have had, since they made this decision.

So, I think that it is very important that this court leaves politics at the door, and the court considers the treaties as being the founding body of the Union and looks only at those purposes. And I think it's wrong that



politics should be brought into it, and looking at the wider political situation, in making the arguments before the court.

The City of London Weighs In

Celani: I was also struck by the speech of the British representative. Because the British are not in the euro, but they are in the European Union. And apparently, his speech demonstrates that it's not about the euro, otherwise the British would not care; they would be indifferent. Or how do you characterize that role?

Pringle: Yes, I suppose, when you look at the City of London and the financial services there, Britain, while they are not a member of the Eurozone, they are very closely linked to the Eurozone. And they would see the survival of the Eurozone and the protection of the euro as being very important to their own interest as well. And for that reason I presume that they went along with the amendment to Article 136 [of the Lisbon Treaty], because it's in their interest.

Celani: Let's take a step back from the discussion of legality, and let's go into politics and into the economy. This raises the issue: What is the ESM for? Is it for the euro, for the states, or is it for the banks, to save the banks?

Pringle: Well, I think it's obvious, and that it's for the banks. And that it's for making the Irish bailout, a bailout right across Europe, where citizens become responsible for the banking debts, debts that they are not responsible for accruing, but citizens will be responsible for in the future.

The ESM is intended to lend money to sovereign states who will use up that money to recapitalize the banks, and the citizens of those states are responsible for the repayment of that money. So, it is an Irish bailout for Europe.

Celani: Yes, your country, Ireland, has been victimized in the first place, because in Euroland it's not allowed to let banks fail. So, the taxpayers have to come in and bail out the banks.

If we had had, in the first place, a strict division, as it's being discussed right now, between commercial banks, deposit banks which are protected by government, and investment banks, which speculate, this would not have been the case. So, are you in favor of this, now?

Pringle: Yes, that wouldn't have been the case if we

had had effective regulation. If the German and French and English banks had acted responsibly in their lending to Irish banks, we wouldn't be in the situation either. So the Irish problem is not the creation of Ireland solely. It is a problem of regulation and the neoliberal politics and market capitalism that have continued for the last number of years.

And I think that we have to make banks responsible for their own debts. At this stage in Ireland, we have given over EU80 billion to our banks. We will continue to pay for the next 30 years, possibly another EU50 billion for the saving of Anglo Irish Bank. All of this to protect the euro! And the Irish people are made responsible for all that debt. Even last week, we paid EU508 million into the ESM, where Germany and other countries are saying it can't sort out our problems retrospectively. So, it shows that the intention is to make citizens responsible for the banking system, and not the banks themselves.

Dark Clouds on the Horizon

Celani: Now, there is the unresolved financial crisis and the deepening economic crisis, because the world is now going again into a recession, and there are big, dark clouds on the horizon. But there are also big, dark clouds on the political horizon in the world, in terms of increasing conflicts. Do you see a connection? Is there a danger that we're going towards a general conflict, if the world economic and financial crisis is not solved?

Pringle: That danger is there, in times of uncertainty, at least, further uncertainty. I think that the steps that are being taken, and the austerity right across the Eurozone and across the world, that have been imposed on citizens, are fueling that crisis and making it even worse.

In the Irish situation, the government tells us that we can take money out of the economy and expect the economy to grow, and we have seen now, over the last four years, that that can't happen! And if you do that on a continent-wide basis—at least it is the situation we have in Ireland, where now one in ten people cannot afford to feed themselves; where we have 80,000 people a year leaving the country to go to other countries in search of work, which, as the economic downturn across the world takes hold, will mean that they will have nowhere to go, and that will create further potential for conflict. Where what we should have, is governments taking responsibility for their citizens rather than

their banks, and dealing with the issues. And the solution to debt is not to add more debt to it.

Celani: Now, this legal procedure will resume in about one and a half hours, and some time in the future, this court will give a verdict, a ruling. What do you think, if the court supports the arguments of the European Union and of the governments—do we have tyranny in this case?

Pringle: Well, I don't like to think what will happen if they do. I think that it will be a very bad day for democracy, across Europe and for citizens. It will mean that the intergovernmental way that the decisions are being made now, will be made to be the future. So, we will see that large countries and strong economic countries will dominate and force their will on other countries, which I think will be a very bad thing for the Union.

Celani: Okay. This is a big challenge for this court. Thank you, Mr. Pringle.

Pringle: Thank you, very much.



Each Wednesday afternoon, Lyndon LaRouche sits down with LPAC-TV Weekly Report host John Hoefle and two guests from the "Basement" scientific team and/or the LaRouchePAC editorial staff, for an in-depth discussion of the most important issues of the week, be they political, economic, strategic, or scientific.

www.larouchepac.com

INTERNATIONAL ASTRONAUTICAL CONGRESS

Space Scientists Meet Amidst Uncertainty and Hope

by Marsha Freeman

As space scientists, engineers, and program managers gathered for the annual International Astronautical Congress (IAC) during the first week in October, the global financial and economic crisis cast a pall over the creative and visionary plans put forward by representatives from more than 70 nations. The crisis, referred to by many of the national space agency representatives, has left the future of space exploration plans uncertain, especially in the United States and Europe. As if to put a point on the crisis, during the week-long Congress in Naples, Italy, a one-day transport workers strike left the more than 4,000 IAC participants scrambling for alternate ways to get to the conference.

Due to budget cutting, many of the visions and goals for future manned exploration and space science missions have narrowed. Mission planning is often circumscribed within what is considered to be “affordable,” or “sustainable” (whatever that means for space exploration).

But the missions that are being carried out today are a testament to the stubborn refusal of space planners to acquiesce to the prospect that there will be no tomorrow. The International Space Station (ISS) partners are looking forward to the next goals for manned space flight, as the assembled station evolves into a base for scientific investigation and preparation for deep-space manned missions. The stunning accomplishment of NASA’s Curiosity rover’s landing on Mars helps to lay the basis for more extensive and intensive unmanned

planetary investigation, and poses the questions for the next steps on Mars.

The newer space nations, particularly China and South Korea, reported on their plans to expand their range of space activities, to become major participants in global exploration. And newly emerging space nations, such as South Africa (which presented 23 papers at the Naples Congress), are, despite desperate domestic economic situations, pushing forward to use and develop space technology, with the understanding that developing such capabilities is a fundamental underpinning for real economic growth.

Even though many of even the most optimistic space planners presented new ideas and proposals with hesitation, often with the caveat: “This program has not yet been approved,” participants recognize that what they do, plays an important role in *creating* the future.

Station Complete: What’s Next?

Over the past year, the Herculean task of assembling the International Space Station has been largely completed, with just a few Russian modules remaining to be deployed. But the retirement of the Space Shuttle last year has left the station entirely dependent upon Russian transport, without any back-up system for the American, Russian, European, Japanese, and Canadian crew members. Now, various proposals are under consideration to develop future Earth-orbital and then deep-space transport alternatives. But the overarching

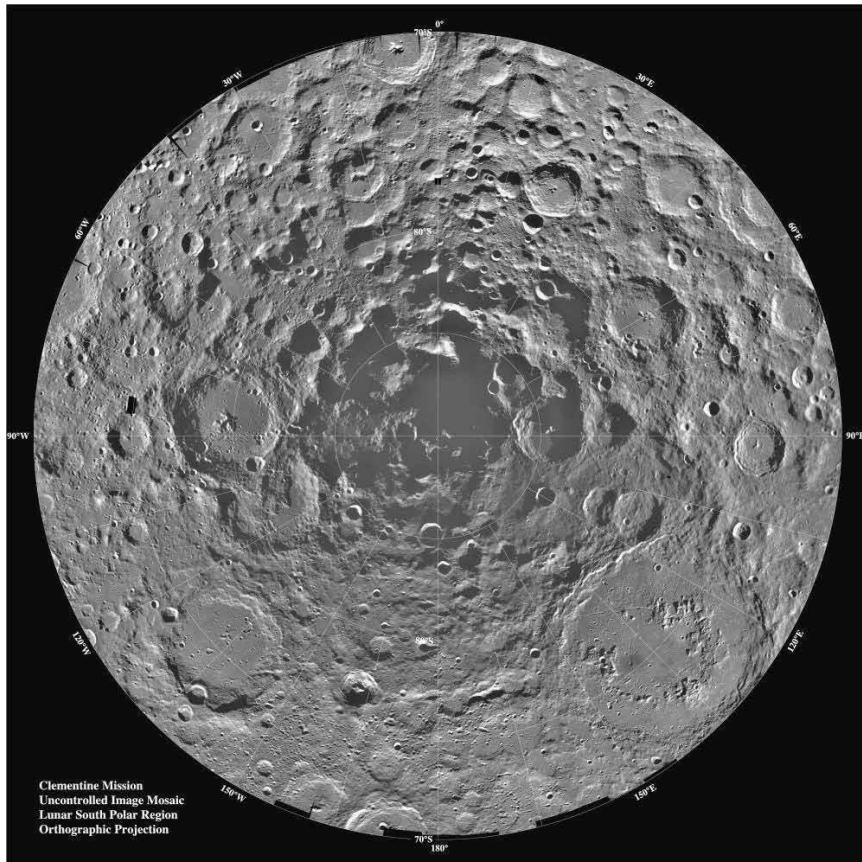

NASA

The 12-mile-wide Shackleton crater, at the lunar south pole, harbors caches of water ice, in the permanently shadowed regions on the crater floor (in the center of this image). Its peaks are in near-perpetual sunlight, also making it a prime target for future lunar exploration.

question, which would determine which transportation and other infrastructure capabilities should be developed, is: “Where do you want to go?”

For the past year, the world’s space-faring nations (minus China, which, thanks to the United States, is excluded) have conducted studies designed to answer that question. The near-unanimous conclusion is that the Moon should continue to be intensively studied robotically, in order to lay the basis for the exploitation of lunar resources, scientific observation, and future manned missions. The fly in the ointment has been the Obama White House, which, for no justifiable reason, has nixed lunar development as the next goal, opting instead for an imagined manned mission to an asteroid.

At this year’s IAC in Naples, challenging proposals were put forward, which take a longer view, and move from past individual, single-goal missions, to a long-term project of development of space infrastructure. Russian speakers at the Congress, in particular, outlined

this approach to create the basis for a multi-decade exploration of space, rather than planning one mission at a time. It is clear to planners looking two or three decades into the future, that the next leaps forward in manned exploration of the Solar System will require an entirely new approach.

The Space Station, in order to offer the widest array of capabilities and to engage the largest number of participants, became “all things to all people,” often with conflicting tasks. In Naples, Russian presentations offered a more rational approach for the future: an “open” rather than a “closed” space station architecture.

The “open architecture” approach was described in a paper by Oleg Saprykin and colleagues, from Russia’s Central Research Institute of Machine Building. This Institute—abbreviated TsNiiMash—is the Russian space program’s think tank, tasked with analyzing proposals and approaches for future space exploration.

Next-generation stations must be “flexible and adaptable,” TsNiiMash proposes, made up of orbital clusters of independent modules, which can

be reconfigured and recombined. The value of creating specialized modules, rather than one all-purpose station, was made clear in the presentation, which showed how materials science experiments, geophysics investigations, life sciences experiments, astrophysics observations, and technology experiments carried out simultaneously, on one large facility, can pose conflicting requirements and interfere with each other on the ISS. A smaller core station, with attendant specialized modules, is more adaptable, and enables the focus of research to change with new developments.

The Time Is Now Ripe

Dr. Alexander Derechin, deputy chief designer of the S.P. Korolyov Rocket and Space Corporation Energia, also suggested in his presentation, that the replacement for the ISS, when it has reached the end of its useful life, should be, not another large, highly complex, and expensive multi-purpose facility, but a smaller

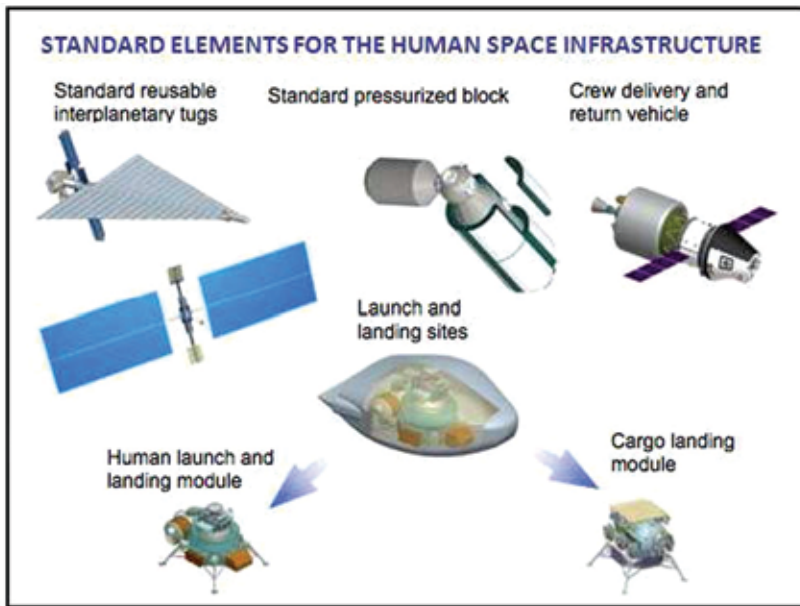

Russian space planners have developed a concept for next-generation space infrastructure, which would include an array of elements, each optimized for a specific task, to lay the basis for future deep-space manned and cargo missions.

base that includes a “cloud” of dedicated, autonomous, man-tended modules. Although the basic hardware would be more economically “mass produced,” each module would have a specific purpose, for which it would be optimized, and could be “man-tended,” rather than continuously occupied. Derechin mentioned a module for astrophysics, oriented to look out at the heavens; one for geophysical studies and remote sensing, looking down on the Earth; a module for the production of materials and biological products in microgravity, absent the disruptive vibrations caused by the movement of humans; and a module to test and verify advanced technologies.

Derechin placed his future space complex cluster in the context of what he proposes for the next 40-50 years: the continued build-up of Earth orbit infrastructure, an Earth-Moon transport system, a lunar base and the exploitation of resources, and the infrastructure to extend human missions beyond the Moon.

This approach is not new, but the time is now ripe. For the past decade, manned space exploration has centered on missions aboard the International Space Station. Now is the time to set new goals. The infrastructure described by Derechin, which he likened to the development of terrestrial infrastructure elements—roads, canals, ports, power supply networks,

and communications—can, like the ISS, be deployed in low-Earth orbit.

But to set mankind on a pathway that can more efficiently service multiple decades of missions to multiple destinations, it is increasingly being proposed to locate next-generation in-space infrastructure at an Earth-Moon Lagrange point, about 64,000 km outside the Moon’s orbit around the Earth. At this L2 point (**Figure 1**) gravitational forces and orbital motions between the Earth and the Moon balance each other, such that a spacecraft placed there will need very little energy to maintain what is described as a “halo” orbit.¹ From the L2 point, a spacecraft can more easily head to any deep space destination, without having to expend the energy to climb out of the gravity well from a planet’s surface, or break free of a planet’s orbit. Destinations could be to lunar orbit, to Mars, to an asteroid, or elsewhere in the Solar System.

In Russia, “we are close to deciding on a Lagrange point [space] station,” Derechin said in his presentation. Because “we don’t know yet” what the next destination will be, the “new principle for infrastructure” should be that “it is not so dependent on the task.”

A Cislunar Gateway

A second paper in Naples, which Dr. Derechin co-authored with Michael Raftery from Boeing, zeroes in on a specific mission concept for lunar exploration, based on an L2 platform. The authors propose that operations in this cislunar region (between the Earth and the Moon) in the near-term, would be integrated with the existing space station infrastructure.

Placing space assets at the Earth-Moon L2 point has advantages over other Lagrange points, or lunar orbit. It can provide global access to the lunar surface, without restriction or limitations on landing sites. As the L2 point is positioned behind the Moon, relative to its orbit around the Earth, a platform there could be in communication with Earth from the far side (non-Earth-facing hemisphere) of the Moon. Dr. Robert Farquhar had proposed that a communications relay satellite be placed at

1. See Dr. Robert W. Farquhar, *Fifty Years on the Space Frontier: Halo Orbits, Comets, Asteroids, and More* (2011).

FIGURE 1

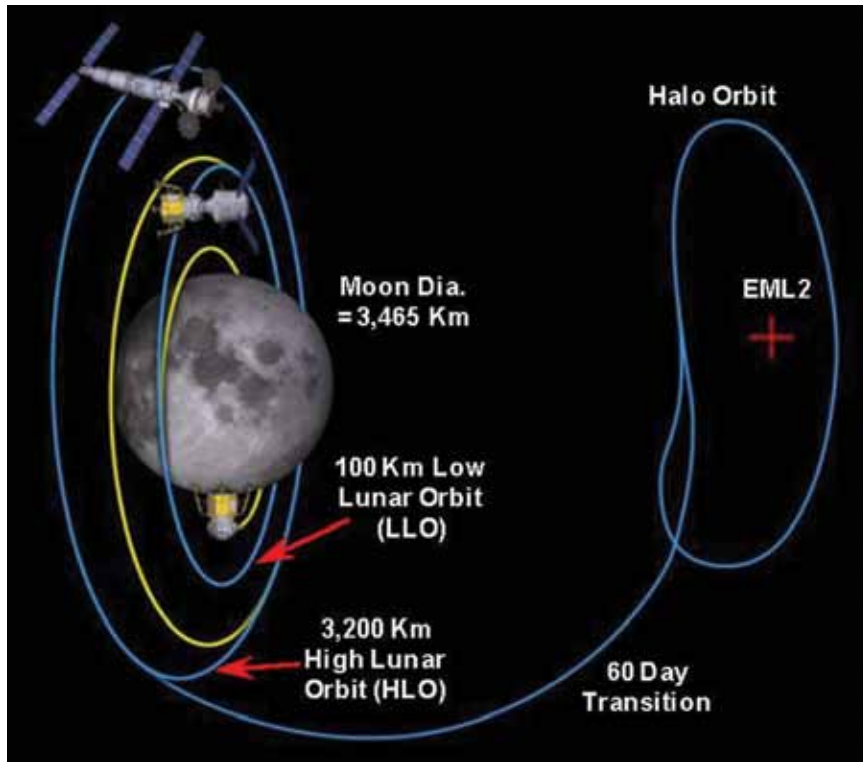

A spacecraft that is placed in a halo orbit at the Earth-Moon Lagrange-2 point (EM L2) would need very little energy to stay in place. This region in space is about 64,000 km farther from Earth than the Moon is, and would be a low-energy transfer point to lunar orbit, as seen here.

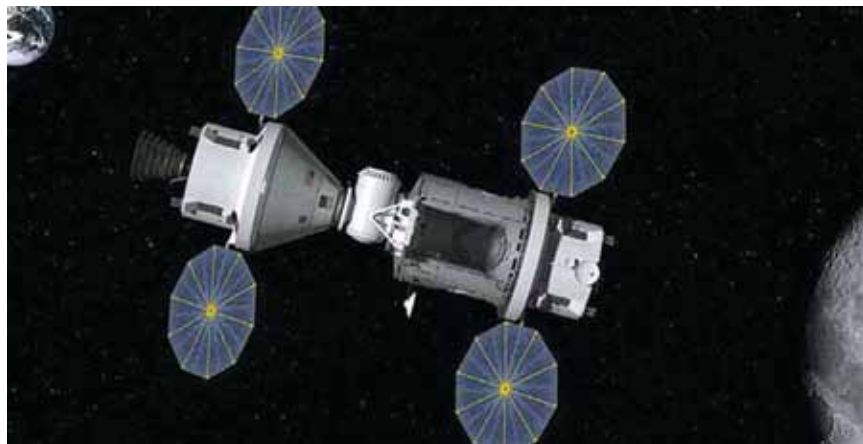

Various designs are being developed to place infrastructure at the Earth-Moon L2 point. In this artist's depiction, a NASA Orion manned space capsule (left) launched from Earth, has linked up with a platform, or "gateway" facility, to be placed at the L2 point, for more efficient travel to further reaches of the Solar System.

the L2 point during the Apollo missions, so the crew would not be out of contact with Mission Control, but that was not done.

Raftery and Derechin explain that their Exploration Platform at L2 could be used as a base for a small, reusable lunar lander, which could be refueled and maintained there. The Platform, the authors suggest, could itself be moved from L2 closer to the Moon, in a high lunar orbit, from which it would deploy a surface vehicle, using less propellant for the landing system.

It is highly unlikely that crews would have long stay-times in cislunar space, as the cosmic radiation is comparable to other deep-space locations. Robotic and teleoperated robotic systems would carry out the next phase of lunar exploration, and deliver supplies to the surface, before the infrastructure were in place for manned landings.

While Lagrange point missions for exploration are under serious study in Russia, NASA has also taken a look. In Naples, NASA associate administrator, Human Exploration and Operations Directorate, Bill Gerstenmaier, commented on studies that have been done, describing the gravity "rivers" that could be followed to chart out the frontiers of exploration. Starting from a halo orbit around L2, Gerstenmaier said, an Orion manned capsule, now under development, could be linked to a new kind of craft—a deep-space vehicle—which would leave the L2 port for an asteroid or Mars.

But a week earlier, NAS issued quick denials when the *Orlando Sentinel* reported the possibility that the space agency would be building a "gateway spacecraft" at the Earth-Moon L2 point as its next step in human space flight.

On Sept. 25, a NASA statement said that the agency was considering "many options" to reach the ultimate aim of sending people to Mars, adding: "We have regular meetings with OMB [Office

of Management and Budget], OSTP [zero-growther John Holdren's Office of Science & Technology Policy], Congress, and other stakeholders to keep them apprised of our progress on our deep-space exploration destinations. . . . President Obama's current policy is to send humans to an asteroid by 2025."

A variety of unmanned, scientific spacecraft have already taken advantage of the unique characteristics of Lagrange equilibrium points between the Earth and the Moon, and the Earth and the Sun. More are planned.

As Derechin explained at the IAC, developing technologies for infrastructure-building and man-tended facilities at these Lagrange points will not be a simple matter of extending what we use in Earth orbit, but will challenge scientists and engineers to create the means, for the first time, to develop deep space.

Overall, it is important to recognize that there is no rationale to go to a Lagrange point in space as a

destination. It is useful to populate it with infrastructure along a pathway to somewhere else. As with the comprehensive space infrastructure proposals on the table from Russian experts, these capabilities must be developed because there is a plan to go somewhere.

In the meantime, on the heels of new discoveries from ongoing missions to the Moon, more ambitious programs are being planned, to bring this nearest part of the Solar System within the domain of human activity.

Regardless of President Obama's idiotic assertion that we need not go back to the Moon, because "we've been there, done that," only a tiny percentage of the lunar orb has actually been intensively studied, and new discoveries from recent missions carried out by the U.S., Europe, China, and India have prompted a renewed thrust toward the Moon.

Learning To Land

Only the United States and the Soviet Union have successfully landed spacecraft on neighboring bodies in the Solar System. Thanks to recent scientific results

indicating caches of precious water ice captured near the south pole of the Moon that are even more extensive than previously estimated, numerous nations are now planning to deliver scientific instruments to the lunar surface, to make their first *in situ* investigations. Recently, for example, an analysis of data from NASA's Lunar Reconnaissance Orbiter indicates that water ice may make up as much as 22% of the surface material in the lunar south pole Shakleton crater. Such a cache

could be the raw material for chemical rocket fuel, and oxygen for future crews.

It has been known since the 1990s that permanently shadowed regions on the floor of the huge, 12-mile-wide Shakleton crater have been the collection point for water ice arriving at the Moon, most likely from comets and meteorites. This extremely cold and dark region near the south pole, therefore, has become a preferred destination for more intensive



The European Space Agency hopes to gain approval at a Ministerial Council meeting in November, to proceed with Europe's first soft landing on the Moon. Launch would be in 2018.

study.

The European Space Agency (ESA) has proposed a Lunar Lander project, which it hopes will be approved in November at the ESA Ministerial Council meeting. The objective is to demonstrate Europe's first soft precision landing, as a precursor mission to future human lunar exploration. Launch would be planned for the end of 2018, with a landing near the Moon's south pole. The challenges include the development of precision navigation and control to safely set the lander down in a region where it must avoid hazardous slopes, obstacles, and, because it is solar powered, shadowed areas.

The payload carried to the surface by the Lunar Lander would examine the properties of lunar dust, the plasma and electric field environment on the surface, the feasibility of making radio astronomy observations, the chemical content of the regolith (soil), and measurements of the radiation environment.

The early Soviet space program carried out a very successful robotic lunar exploration program, starting

only two years after the 1957 launch of Sputnik. That history was dramatically recalled in a paper in Naples, by Prof. Vyacheslav Ivashkin, from the Keldysh Institute of Applied Mathematics. But as scientists point out, all the data from more recent missions makes this in effect a “new” Moon, which requires more advanced high-precision landing, multiple assets operating at once, and the ability to operate under the Moon’s most extreme environment.

At the IAC in Naples, it was reported that the delayed Russian Luna-Glob project has been split into two missions, which are both under development. The failure of the Phobos-Grunt mission to Mars nearly a year ago, led to a reexamination of the upcoming lunar missions, and, according to officials from the Lavochkin Aircraft and Space Design Bureau, which designs and builds Russia’s planetary spacecraft, some updating of the lunar spacecraft systems has been done. Scientists also wanted to be able to deploy more payload—up to 50 kilograms—than originally planned. Splitting the Luna-Glob program into two missions means there is more room available for experiments on each spacecraft, Roscosmos head Vladimir Popovkin explained earlier this month. The updates and changes that were made in the missions were approved by the National Academy of Sciences this Summer.

At present, the plan is for a 2015 launch for Luna-Glob 1, which will demonstrate the soft landing of a small craft, to test new technologies. It will be followed the next year by the Luna-Glob 2 mission, which will deploy an orbiter, to study the Moon from a 500km, then 150km, and finally a low 50km altitude. “We must touch down on the Moon in 2015,” Lavochin’s director general, Viktor Khartov, told ITAR-Tass on Oct. 12. “The Phobos probe failure is a scar on all of us,” he said. “We must touch down on the Moon to show ourselves that we can do it.” The Moon missions have been fully funded, he stated.

The Luna-Resurs mission, scheduled for launch in 2017, will be a 200kg “scientific station,” able to drill for and analyze samples at the lunar south pole. Speaking at the third International Solar System Symposium in Moscow on Oct. 12, Popovkin and Director of the Space Research Institute of the Academy of Sciences Lev Zelyony described the Luna-Resurs as “heavily laden” and “heavily tasked.” Upon touchdown on the surface, the lander will release a small Indian robotic rover.

Even in the U.S., where the Administration has

downplayed the importance of the exploration of the Moon (although with some backtracking, in the face of strident criticism), new designs for small rovers are being developed, and scientists and engineers continue to develop possible future missions.

In Naples, the U.S.-Canadian RESOLVE mission was described, which is designed to land near the permanently shadowed regions of Cabeus Crater, to investigate the concentration of volatiles, such as water ice. The Regolith and Environment Science and Oxygen and Lunar Volatiles Extraction mission could be launched in 2016. The Canadian Space Agency is designing a rover for the mission, and a drill, which would be one of the scientific payload elements.

Like the lander designs proposed by ESA, RESOLVE is being designed as a solar-powered system. The rationale is that solar systems are cheaper, and because they are lighter, also reduce the weight of the spacecraft, and, therefore, the cost of launching it. The drawback is the constraint imposed, to find a sunny spot for solar recharge, when, depending upon the landing site, a rover is going to spend at least some time in darkness. William Larson, from NASA’s Kennedy Space Center, explained that with solar power, the proposed mission would last only six days!

Japan and China, which have already operated spacecraft in lunar orbit, are now planning their follow-on missions which will include landers. The Chang’e 3 craft, scheduled to be launched next year, will position China as the first nation to make a soft landing on the Moon in more than 30 years. Unlike comparable missions, Chang’e 3 will include a nuclear “battery,” containing plutonium 238, to provide heat and power, similar to the arrangement on NASA’s Curiosity Mars rover.

Japan’s SELENE 2 is under study, to also include a lander and rover, although without the advantage of nuclear isotope technology. The team from the Japan Space Exploration Agency (JAXA) which presented the SELENE-2 plans, reported that “because of the shortage of the government budget, [the] development plan [for] SELENE-2 is delayed.” Even the 2017 launch schedule, they reported, “is not authorized yet.”

A new entrant to lunar exploration is South Korea. Representatives from the Korea Aerospace Research Institute (KARI) reported on the conceptual design for a lunar lander demonstrator. A ground-based demonstrator has been developed to test the feasibility of basic

structure and design, and landing technologies.

The timetable presented for the Korean lunar orbiter and lander is pushed out past 2020, it was reported, because a Korean rocket launcher that can lift the necessary payload is not scheduled to be ready until then.

Prelude to Returning Samples from Mars

The holy grail of Mars exploration in the scientific community has been the collection of carefully selected Martian soil and rock samples, and their return to Earth. No matter how sophisticated the analytic equipment put on unmanned rovers may be, there is no substitute for subjecting pieces from Mars to the analytic capabilities of laboratories on Earth.

Until last February, the next steps in Mars exploration to culminate in a sample-return mission, were the joint European-U.S. ExoMars 2016 and 2018 missions. After the U.S. withdrew its participation, the missions have been reworked into a joint European mission with Russia.

In the 2020 time frame, ESA has plans to team with the Russian Space Agency, for a Lunar Polar Sample Return mission, as a precursor to a more challenging Mars Sample Return mission later that decade. This mission comes under a framework of long-term cooperation between the two space agencies, and leverages the near-term missions planned separately by each.

As described at the Naples conference, the proposed Lunar Polar Sample Return is “a very complex and ambitious mission” with many technical challenges. It is to consist of different elements, including landers, rovers, sample collection capabilities, and rocket stages to return the samples to Earth. All of these elements must be landed in close proximity to each other, and function together.

ESA will apply its experience from its 2016 and 2018 ExoMars missions, and its proposed 2018 Lunar Lander. The Russians will have completed their 2015 and 2016 Luna-Glob missions, and their 2017 Luna-Resours mission will verify many of the technologies needed for the sample-return mission, such as landing a

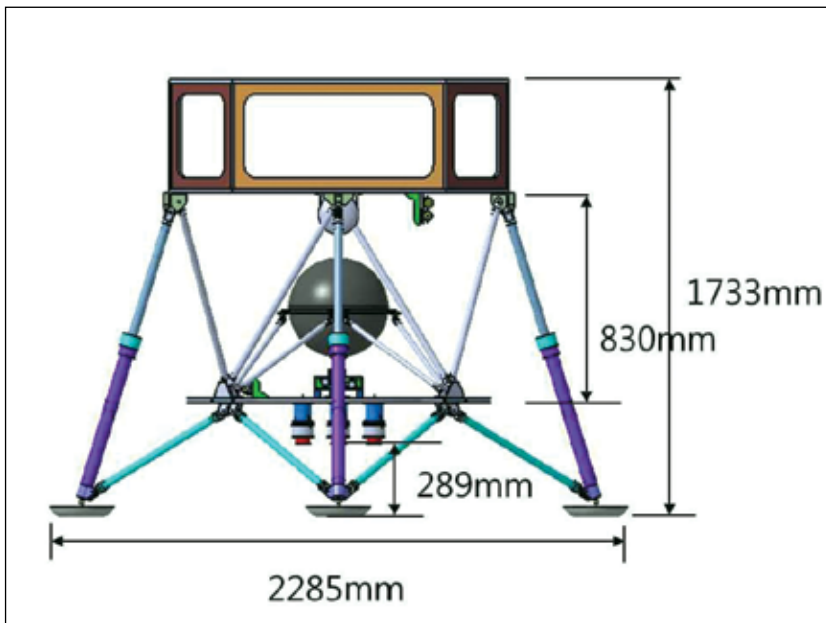

The Korea Aerospace Research Institute is conducting a design study for an orbiter and lander project, and is developing a ground-based demonstrator to test the various subsystems that the project will require.

large platform, acquiring samples, and *in situ* scientific analysis.

Where is the United States in this long-range plan?

The unconscionable cancellation of NASA’s well-planned and systematic Mars exploration program was followed more recently by the Congressional stupidity of cutting NASA’s travel budget. As a result, half of the scientists from the Jet Propulsion Laboratory, which manages NASA’s Mars and other planetary missions, were unable to attend the Naples Congress to present their papers. Similarly, the American Astronautical Society has *cancelled* its November annual conference, because NASA officials could not obtain the funds to travel to Pasadena.

As the Naples conference came only a month before the U.S. Presidential election, attendees recognized that the political landscape, and NASA’s future, could change overnight. How, remains to be seen.

The future is created by those who can imagine it. No space mission is done in the “here and now.” One of the encouraging signs at this year’s international conference was that one third of the participants were under the age of 35. They will see the future.

But space exploration “during a time of austerity” can quickly become no space program at all.

Editorial

The Unnatural Disaster

The major disaster the American population faces is *not* the effects of Hurricane Sandy, as devastating as that storm turned out to be. The real catastrophe is the fact that, six days before the U.S. Presidential elections, there is no candidate on the ballot who has the competence to deal with the physical-economic consequences of the storm, not to mention the broader life-threatening strategic and economic crises which face our nation, and the world. To the contrary, the stated policies of *both* will lead to our destruction.

In other words, this is not the time to “choose sides” between the “teams” fighting for the Presidency. Rather, as Lyndon LaRouche is emphasizing, the only solution is to intervene to change the agenda, and the rules of the game; to, in effect, let Romney and Obama destroy each other, while true patriots impose an agenda of recovery and long-term international war avoidance, which LaRouche has been laying out for quite some time.

It is in this context that LaRouche has taken the extraordinary step of publicly announcing an election-eve press conference at Washington’s National Press Club on Nov. 2, in order to define the strategic options the world faces. This will be only the second time in his long political career that LaRouche has taken this step—the first being after the election victory of two of his supporters in Illinois state elections in 1986. This event promises to shake up the nation.

In strategic significance, it can be compared to another “election-eve” appearance by LaRouche back in 1976, right before the watershed election contest between Jimmy Carter and Gerald Ford. At that time, LaRouche was a candidate for the Presidency on a third party ticket, but he was not under any illusion that he could win. Rather, the explicit

purpose of his political bombshell was to mobilize a new political combination around those policies which could bring the world back from the brink of a war confrontation between the U.S. and the Soviet Union.

LaRouche’s short presentation defined the issues facing the U.S. electorate “from the top” in shocking detail. He identified two Trilateral Commission policies being pushed by the Carter campaign: first, the outright genocidal, depopulation economic policy being promoted by Carter economic advisor George Ball, among others, for the “Third World” and elsewhere; second, the inexorable consequence of such a policy in bringing the United States and NATO, into confrontation with the Soviet Union that would lead to nuclear war. He then laid out his own solution, which was already being adopted in part by leading Third World nations—the International Development Bank—which, he argued, would create the conditions for global cooperation and peace.

What was the impact of LaRouche’s intervention? In the short-term, it did not succeed in stopping the Carter war party from winning—although substantial evidence of vote fraud was available, and only a political decision by the top of the Ford campaign stopped viable election challenges from being pursued. But there is no question but that LaRouche’s election eve speech was crucial in laying the basis for later dramatic positive developments—such as Ronald Reagan’s Strategic Defense Initiative, and his offer for collaboration with the Soviets.

So, when LaRouche takes the podium Nov. 2, it’s time to pay very close attention—and be prepared to act.

SUBSCRIBE TO

EIR Executive Intelligence Review **EIR Online**

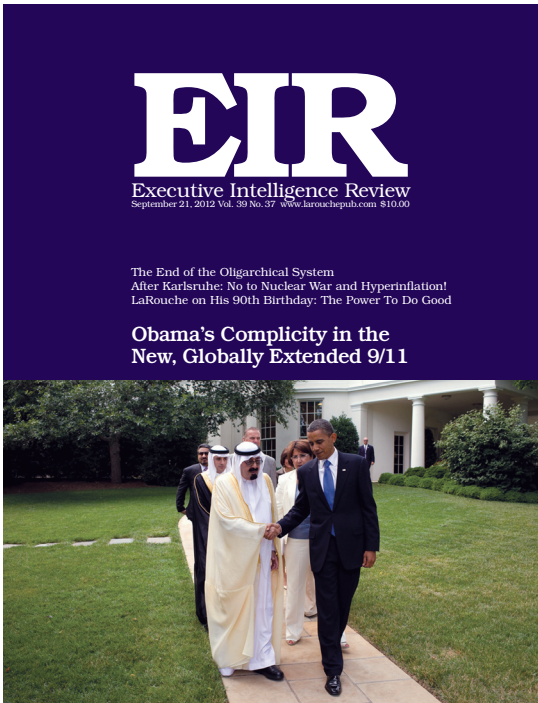

EIR Online gives subscribers one of the most valuable publications for policymakers—the weekly journal that has established Lyndon LaRouche as the most authoritative economic forecaster in the world today. Through this publication and the sharp interventions of the LaRouche Movement, we are changing politics worldwide, day by day.

EIR Online

EIR Online includes the entire magazine in PDF form, plus up-to-the-minute world news.



I would like to subscribe to **EIR Online**

(e-mail address must be provided.)

- \$360 for one year
 - \$180 for six months
 - \$120 for four months
 - \$90 for three months
 - \$60 for two months
- Send information on receiving **EIR** by mail.

—EIR Online can be reached at:

www.larouchepub.com/eiw

e-mail: **fulfillment@larouchepub.com**

Call **1-800-278-3135** (toll-free)

Name _____

Company _____

Address _____

City _____ State _____ Zip _____ Country _____

Phone (_____) _____

E-mail address _____

I enclose \$ _____ check or money order

Make checks payable to

EIR News Service Inc.

P.O. Box 17390, Washington, D.C. 20041-0390

Please charge my MasterCard Visa

Card Number _____

Signature _____

Expiration Date _____