

# EIR

Executive Intelligence Review

July 6, 2007 Vol. 34 No. 27 [www.larouche.com](http://www.larouche.com) \$10.00

LaRouche to Youth: Make a Revolution in Science  
Even Some Brits Want To Go After the BAE  
'No Technical Limits' to Bering Strait Project

**BAE Scandal Demands  
Cheney Impeachment Now!**

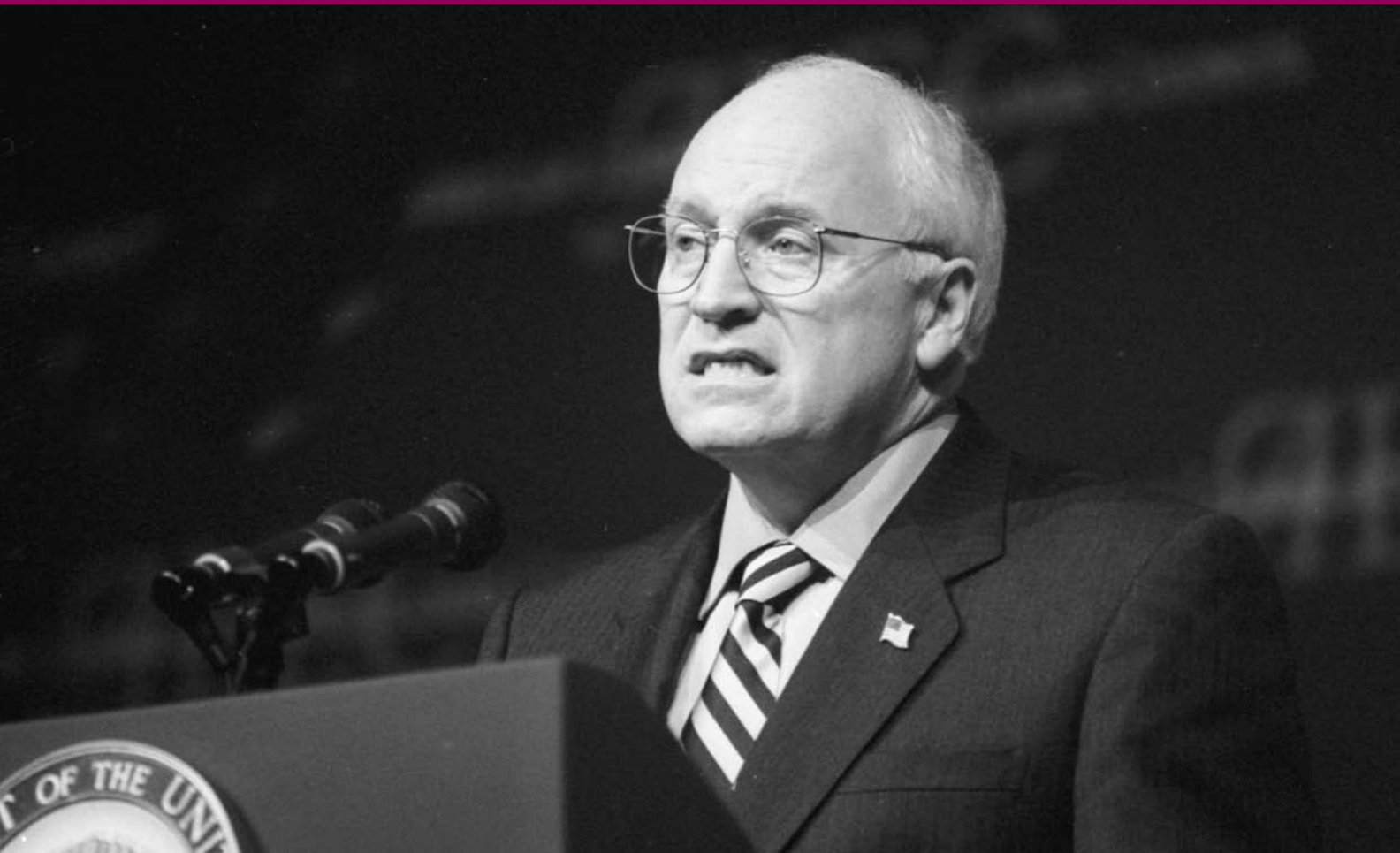

Founder and Contributing Editor:

*Lyndon H. LaRouche, Jr.*

Editorial Board: *Lyndon H. LaRouche, Jr., Muriel*

*Mirak-Weissbach, Antony Papert, Gerald Rose,*

*Dennis Small, Edward Spannaus, Nancy*

*Spannaus, Jeffrey Steinberg, William Wertz*

Editor: *Nancy Spannaus*

Managing Editor: *Susan Welsh*

Assistant Managing Editor: *Bonnie James*

Science Editor: *Marjorie Mazel Hecht*

Technology Editor: *Marsha Freeman*

Book Editor: *Katherine Notley*

Photo Editor: *Stuart Lewis*

Circulation Manager: *Stanley Ezrol*

#### INTELLIGENCE DIRECTORS

Counterintelligence: *Jeffrey Steinberg, Michele Steinberg*

Economics: *Marcia Merry Baker, Paul Gallagher*

History: *Anton Chaitkin*

Ibero-America: *Dennis Small*

Law: *Edward Spannaus*

Russia and Eastern Europe:

*Rachel Douglas*

United States: *Debra Freeman*

#### INTERNATIONAL BUREAUS

Bogotá: *Javier Almaro*

Berlin: *Rainer Apel*

Copenhagen: *Poul Rasmussen*

Houston: *Harley Schlanger*

Lima: *Sara Madueño*

Melbourne: *Robert Barwick*

Mexico City: *Rubén Cota Meza*

New Delhi: *Ramtanu Maïtra*

Paris: *Christine Bierre*

United Nations, N.Y.C.: *Leni Rubinstein*

Washington, D.C.: *William Jones*

Wiesbaden: *Göran Haglund*

#### ON THE WEB

e-mail: [eirms@larouchepub.com](mailto:eirms@larouchepub.com)

[www.larouchepub.com](http://www.larouchepub.com)

[www.larouchepub.com/eiw](http://www.larouchepub.com/eiw)

Webmaster: *John Sigerson*

Assistant Webmaster: *George Hollis*

---

EIR (ISSN 0273-6314) is published weekly (50 issues), by EIR News Service, Inc., 729 15th St. N.W., Washington, D.C. 20005. (703) 777-9451

**European Headquarters:** E.I.R. GmbH, Postfach 2308, D-65013 Wiesbaden, Bahnstrasse 9-A, D-65205, Wiesbaden, Federal Republic of Germany Tel: 49-611-73650

Homepage: <http://www.eirna.com>

e-mail: [eirna@eirna.com](mailto:eirna@eirna.com)

Director: Georg Neudekker

**Montreal, Canada:** 514-855-1699

**Denmark:** EIR I/S, Sankt Knuds Vej 11, basement left, DK-1903 Frederiksberg, Denmark. Tel.: +45 35 43 60 40, Fax: +45 35 43 87 57. e-mail: [eirdk@hotmail.com](mailto:eirdk@hotmail.com).

**Mexico:** EIR, Manual Ma. Contreras #100, Despacho 8, Col. San Rafael, CP 06470, Mexico, DF. Tel.: 2453-2852, 2453-2853.

Copyright: ©2007 EIR News Service. All rights reserved. Reproduction in whole or in part without permission strictly prohibited.

Canada Post Publication Sales Agreement #40683579

**Postmaster:** Send all address changes to EIR, P.O. Box 17390, Washington, D.C. 20041-0390.

# EIR

## From the Assistant Managing Editor

Our issue this week aims to stimulate you to take on two enormous tasks: To ensure the near-term elimination of Dick Cheney—now in deep kimchee with his British masters—from any role in U.S. policy-making; and secondly, with that huge obstacle removed, to begin to reverse the disastrous effects of the policies that Cheney and company have wrought, by joining the scientific revolution initiated over recent months by members of the LaRouche Youth Movement, working in “The Basement.”

As we document in our cover story, Cheney is indeed in the target zone, as the explosive exposé of the BAE “Scandal of the Century” unfolds internationally—but nowhere other than *EIR* will you find the real story, which places Cheney at the center of the attempted coverup of a multi-billion-dollar slush fund, run through the British arms cartel, BAE Systems. The 250,000 LaRouche PAC leaflets, titled, “LaRouche to Speaker Pelosi: BAE Scandal Demands Cheney Impeachment Now!” (see *Investigation*, and available for download at [www.larouchepac.com](http://www.larouchepac.com)), have begun to hit the streets throughout the nation.

Three days after LaRouche’s June 21 webcast, in which he unleashed the Furies against Cheney, the *Washington Post* began its sensational four-part, front-page series, documenting Cheney’s multiple impeachable crimes; Senator Kerry issued a call for a public inquiry on the BAE scandal; and two leading Republican Senators issued calls to end the Iraq War (see *National*).

In this week’s *Science* section, you will find LaRouche’s bid to an international LYM audience, to create a renaissance in science, which as you will see the articles that follow, is already well underway. This first published report from the LYM’s current “Basement Team,” initiates a series of interim research papers. And pointing in the direction of the great projects humanity will soon begin to embark upon, as we clear the deadwood from Washington, is Louis Cerny’s optimistic report, “No Technical Limits to Bering Strait Project.”

As is our custom, *EIR* will skip an issue next week, in order to commemorate Independence Day.



## Cover This Week

*Dick Cheney's crimes are so exposed, since the BAE scandal broke, that the clamor for his departure—whether by resignation or impeachment—is becoming deafening.*

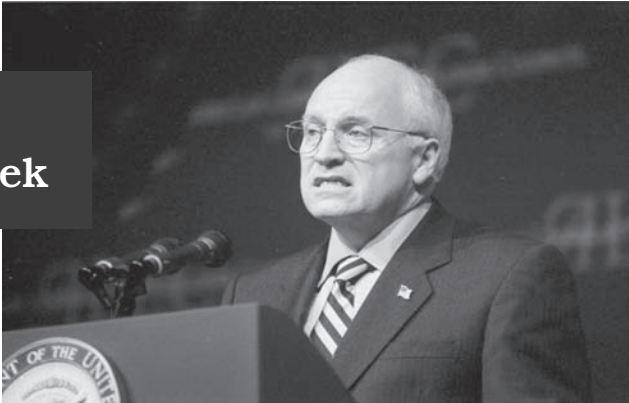

EIRNS/Stuart Lewis

### **4 LaRouche to Speaker Pelosi: BAE Scandal Demands Cheney Impeachment Now!**

Lyndon LaRouche, in response to revelations that Vice President Cheney is behind the unsuccessful effort to cover up the \$80-100 billion criminal slush fund run through the British arms cartel BAE Systems, stated that some of Speaker of the House Nancy Pelosi's friends "will rant and rave that British imperial asset Dick Cheney must be kept in place, but Cheney's role in the recently bungled BAE coverup makes him a prime candidate for early removal from office."

### **6 The BAE Systems Affair and the Anglo-Dutch Imperial Slime Mold**

### **8 BAE, Baroness Symons, in Black Operations Against LaRouche**

### **11 John Train and BAE**

### **13 Crown Agents: The British Monarchy's Direct Links to BAE**

Reprinted from *EIR*'s 1997 Special Report "The Coming Fall of the House of Windsor."

## Science

### **16 LaRouche Challenges Youth: Make a Revolution in Science**

In an address to a LaRouche Youth Movement cadre school, in which young people on four continents participated, Lyndon LaRouche challenged them to take up the most fundamental principle in physical science: the infinitesimal, "the most powerful force in the universe." The unique historical role for this new generation, LaRouche said, is "to guide the changes which must occur in society, if society itself is to survive."

### **28 Welcome Adventurer!**

A small group of LaRouche Youth Movement (LYM) researchers, known as "The Basement Team," since they are operating from the basement of a farm in Northern Virginia, presents a preliminary report on their investigations into the most crucial breakthroughs made in scientific method.

### **29 How the Venetians Tried To Erase Kepler From Science: Empiricism as Anti-Creativity**

LYM member Peter Martinson describes the scientific environment at the time that German scientist Carl Friedrich Gauss made his famous determination of the orbit of the asteroid Ceres. It was a pitched battle between the adherents of Johannes Kepler, and the ideologues of the so-called Enlightenment.

## National

### 40 LaRouche's June 21 Webcast: A Turning Point in History and a Dark Day for Dick

LaRouche's June 21 webcast triggered an avalanche of attacks on Vice President Cheney, which has destroyed what was left of his political career as a key thug-asset of London-centered financial circles; and a split between certain U.S.-based political factions and the Anglo-Dutch oligarchy.

**Documentation:** Leading GOP Senators Urge Iraq Disengagement: Excerpts from a speech by Sen. Richard Lugar (R-Ind.) and a strategy paper by Sen. George Voinovich (R-Ohio).

### 48 Dick Cheney's War Is Driving Troops Crazy

### 50 Conyers, Moore Promote Universal Health Care

## International

### 52 International Attacks on BAE: The Real Target Is Cheney

A faction fight has broken out within the British Establishment over the BAE Systems scandal, and Dick Cheney is in deep trouble with his erstwhile London friends.

### 54 John Bredekamp Puts His Foot in It

The Editors reply to a letter from John A. Bredekamp.

### 57 European Union: German Chairmanship Missed Crucial Issues

## Economics

### 62 Bear Stearns Funds' Failure Opens the Door to Credit Crash

The failure on June 19 of two Bear Stearns hedge funds, linked to the subprime mortgage and Mortgage Backed Securities market, had Wall Street's Plunge Protection team working behind the scenes to relieve the pressure.

### 64 New Pension Crisis Seen in Credit Markets Crash

### 66 No Technical Limits to Bering Strait Project

### 69 Bush Nuclear Program: Technology Apartheid

## Departments

### 71 Banking

Blackstone Goes Public.

## Book Reviews

### 58 Roosevelt-Stalin Correspondence Sheds Light on FDR Post-War Vision

*My Dear Mr. Stalin: The Complete Correspondence of Franklin D. Roosevelt and Joseph V. Stalin*, edited by Susan Butler, with a Foreword by Arthur Schlesinger, Jr.

## Editorial

### 72 Independence Day 2007

LAROCHE TO SPEAKER PELOSI:

## BAE Scandal Demands Cheney Impeachment Now!

*The following statement was released by the LaRouche Political Action Committee (LPAC) on June 25; a quarter-million copies are being printed for distribution throughout the United States. The leaflet is posted at [www.larouchepac.com](http://www.larouchepac.com) and can be downloaded for printing and circulation.*

New revelations that Vice President Dick Cheney has been behind the now-failed effort to cover up an \$80-100 billion criminal slush fund, run through the British arms cartel BAE Systems, adds new urgency to Lyndon LaRouche's longstanding demand that Vice President Dick Cheney be impeached or otherwise removed from office for high crimes and misdemeanors. LaRouche, following his June 21, 2007 international webcast, has demanded that Speaker of the House Nancy Pelosi drop her stubborn and ill-conceived rejection of the need to remove Cheney from office, and take the lead in his immediate impeachment.

"I know," LaRouche said on June 24, "that some of Speaker Pelosi's friends, including Felix Rohatyn, will rant and rave that British imperial asset Dick Cheney must be kept in place, but Cheney's role in the recently bungled BAE coverup makes him a prime candidate for early removal from office; and the survival of the United States and the world depends on that action. Speaker Pelosi must put those considerations above the desires of Rohatyn, George Shultz, and other Cheney protectors, or else the Democratic Party may self-destruct before the November 2008 Presidential elections, in light of growing voter anger that the new Democratic Congressional leadership has failed to act on the public mandate for impeachment."

A late June 2007 four-part *Washington Post* front-page exposé of Vice President Cheney's role in the ripping up of the U.S. Constitution in pursuit of an Executive Branch wartime dictatorship—echoing LaRouche's Jan. 3, 2001 pre-9/11 warnings that Cheney would be the "Hermann Göring" of the Bush Administration, and the architect of a future "Reichstag fire" incident, aimed at establishing totalitarian rule—further sets the stage for Cheney's immediate ouster. Clearly, Cheney's

failure to bury the BAE scandal in both Britain and the United States, as LaRouche observed in his June 21 webcast, has angered Cheney's backers, and they may find themselves now in common cause with the vast majority of Americans who want him removed from office, albeit for different motives.

The LaRouche Political Action Committee website, [www.larouchepac.com](http://www.larouchepac.com), has assembled a comprehensive dossier on the unfolding BAE scandal, which already represents the "Scandal of the Century," beyond even the 9/11 story, which has more to do with BAE than most people can imagine. LPAC, along with the investigative staff of *Executive Intelligence Review*, the weekly magazine and online journal founded by LaRouche, will continue to provide the only comprehensive source of information on the BAE scandal, as it fully unravels. To date, the international media has been either silent, or has avoided the most significant features of the BAE-centered off-budget criminal enterprise. If you are serious about your responsibilities as a citizen, you must understand the significance and implications of the BAE scandal. You owe it to yourself to go to the LaRouche PAC website now, and make sure that your friends, your neighbors, your relatives, and your elected officials do the same.

### Essentials of the BAE Scandal and Cheney's Role

A brief summary of the BAE scandal should make the point all the more obvious, why you must go to the LaRouche PAC website for the real, unfolding story.

In 1985, the Margaret Thatcher-led British government, signed a long-term agreement with the Saudi Arabian monarchy, under which the British arms cartel, BAE Systems, provided fighter jets and other military equipment and services, in return for vast quantities of Saudi oil. The barter agreement, known as "Al-Yamamah" (the Arabic word for "the dove") has remained in force up to the present day. Under Al-Yamamah, a tightly interlocking consortium of Anglo-Dutch and Anglo-American cartels—including BAE, BP, Royal Dutch Shell, Lazard Bank, HSBC (formerly the British East India Compa-



The Washington Post's four-part series on Cheney illustrated graphically that his backers have decided that he is, as Lyndon LaRouche put it, "dead meat."

Washington Post

ny's Hongkong and Shanghai Banking Corporation), and the Carlyle Group—has amassed an estimated \$80-100 billion in off-budget, hidden funds, which have been utilized for covert operations and gun-running on a global scale—totally outside the jurisdiction and oversight of any government. This massive offshore fund is at the center of the power of the Anglo-Dutch financial oligarchy, which has promoted globalization and perpetual war for the last three decades and longer.

Under the Al-Yamamah agreements, which have been perpetuated by every British government, from Thatcher through John Major, to outgoing "New Labour" Prime Minister Tony Blair, Saudi Arabia has provided 600,000 barrels of crude oil to BAE every day since September 1985. According to the authorized biography of Saudi Prince Bandar bin-Sultan, the architect of the Al-Yamamah deal on the Saudi side, and a long-suspected recruit of Britain's MI6, working through BP and Royal Dutch Shell, BAE has sold this oil on the international retail markets. According to BP's own data base on world oil prices, the value of the cumulative oil sales, in current U.S. dollars, is an estimated \$160 billion. The military equipment and services provided to Saudi Arabia in return for the oil, over the past 22 years of Al-Yamamah, is estimated at \$40 billion—before the prices were boosted by a reported 30-40%, to provide for "commissions" and other payoffs, including \$2 billion to Prince Bandar.

The question to be raised: What happened to the rest of the money? Evidence suggests that tens of billions of dollars went to the black market purchase of weapons, to fuel wars from Afghanistan, to Africa, to Central America. Bandar's biographer William Simpson described it as "a backdoor method of

covertly buying U.S. arms ... military purchases that would not be visible to Congress."

### Cheney's Bungled Coverup

In November 2006, Prince Bandar, the former Saudi Ambassador to the United States, now back in Riyadh as the national security advisor to King Abdullah, orchestrated a secret visit to the Kingdom by Vice President Dick Cheney. The primary topic was Cheney's promotion of an American military strike against Iran, and a larger Sunni versus Shi'ite perpetual war confrontation within the Muslim world. But the other issue on the table was the BAE scandal, which was again grabbing media attention in Great Britain and was the subject of an ongoing probe by the U.K. Serious Fraud Office (SFO). Cheney vowed to shut down the probe and bury any further interference in the Al-Yamamah deal, according to two subsequent reports in the U.S. media. Within weeks of the Cheney meetings in Riyadh, Blair and his Attorney General, Lord Goldsmith, announced the shutdown of the Al-Yamamah probe for "national security" reasons.

However, this time, Cheney's strongarm tactics backfired, and an international furor was ignited by the British coverup, triggering new investigations by the OECD, the Swiss government, the Hungarian government, and even the U.S. Department of Justice. In that context, the EIR revelations about the "Scandal of the Century" have delivered a further shock to the system, and have created the conditions where, in LaRouche's words, Cheney's "role has been depreciated greatly. He has failed to put the lid on the story. The story is now out. Cheney is in deep kimchee, and those who don't want to impeach Cheney are in deep kimchee too."

# The BAE Systems Affair and The Anglo-Dutch Imperial Slime Mold

by John Hoefle

The weapons-for-oil deal between BAE Systems and the Kingdom of Saudi Arabia provides a useful window into the manner in which the Anglo-Dutch-centered international financial oligarchy operates. The oligarchy is essentially a private criminal enterprise which stretches across the globe, operating through a network of government agencies, private institutions, and both publicly owned and private corporations and financial institutions. Some of these relationships are out in the open, while others are hidden.

The British Empire's historic role in the Asian opium trade is a good example of how the oligarchy functions. As documented by *EIR* in the book *Dope, Inc.*, the British used Hong Kong as their base of operations, with Scottish trading companies such as Jardine Matheson both moving the product and setting up the Hong Kong and Shanghai Banking Corp. (now HSBC) to handle the prodigious financial flows. As a British colony, the government of Hong Kong was run by the British monarchy, but the power was that of the British East India Company and the other private interests which controlled the British monarchy and the Empire, and the method by which this power was administered was, and is, Venetian.

This report looks at some of the corporate structures involved in the BAE deal, and unavoidably involves a straightforward connect-the-dots approach, but it is important for the reader to keep in mind that, while individual corporations are involved, the source of their corruption lies without, like an infecting virus. One must look at the larger operation in perspective, to understand how it actually works.

The BAE-Saudi deal is essentially an oil-for-weapons swap involving the largest British weapons manufacturer, and a nation that is essentially a creature of the London-centered international oil cartel, in which Royal Dutch Shell and BP are major factors. Associated with this BAE-Shell-BP nexus are a number of important investment and commercial banks, other weapons manufacturers, and raw materials companies.

We start with the BAE Systems board of directors:

- BAE chairman **Richard Oliver** is a former director and deputy group chief executive of BP, and a director of Reuters, the British news/propaganda arm which is headed by a Knight Commander of the British Empire, Sir Niall FitzGerald.

- BAE chief executive officer **Michael Turner** is a director of Lazard, the Venetian bank with ties to the British Round Table group, the French Synarchy, the Venetian circles around

Assicurazioni Generali, and the United States. Lazard is also closely connected to the international war materials cartels, and to Royal Dutch Shell.

- BAE director **Philip Carroll** is a former president and chief executive of Shell Oil Company, the Houston-based U. S. arm of Royal Dutch Shell. Carroll is also a former chairman and chief executive of Fluor, the giant engineering company currently headed by Lord Robin Renwick, a vice chairman of J.P. Morgan Cazenove. Additionally, Carroll is a member of the advisory board of the James A. Baker III Institute for Public Policy at Houston's Rice University, a school which has a long history as a British outpost in the United States.

- BAE director **Sir Nigel Rudd** is deputy chairman of Barclays, the largest bank in the world by assets. Barclays has interlocking directorships with not only BAE, but Goldman Sachs, J.P. Morgan Cazenove, raw materials powers Rio Tinto and Freeport McMoRan, and British newspaper publisher Trinity Mirror.

- BAE director and chief operating officer **Walt Havenstein**, who heads BAE's U.S. unit, is a former employee of both Lockheed Martin's Sanders unit and Raytheon, and is said to have extensive knowledge of ultra-secret electronic warfare systems.

- BAE director **Michael Hartnell** is a retired finance director of British plastics and packaging company Rexam, and is a director of Lonmin, the notorious mining company formerly known as Lonrho. Lonmin chairman Sir John Craven is also chairman of the private bank of the wealthy Fleming family.

- BAE director **Dr. Ulrich Cartellieri** is a long-time member of the international advisory board of the Federal Reserve Bank of New York, a former official and director of Deutsche Bank, and a current and former director of a number of German industrial companies.

- BAE director **Andy Inglis** is a former managing director of BP and head of its exploration and production arm.

- BAE director **Sir Peter Mason** is the retired chief executive of AMEC plc, a British engineering firm with ties to N.M. Rothschild.

- BAE director **Roberto Quarta** is a partner with the U.S. private equity firm Clayton, Dubilier & Rice, which has deep ties to the Morgan and Rothschild interests in the United States.

FIGURE 1  
**The Anglo-Dutch Interlocking Directorate Behind BAE**

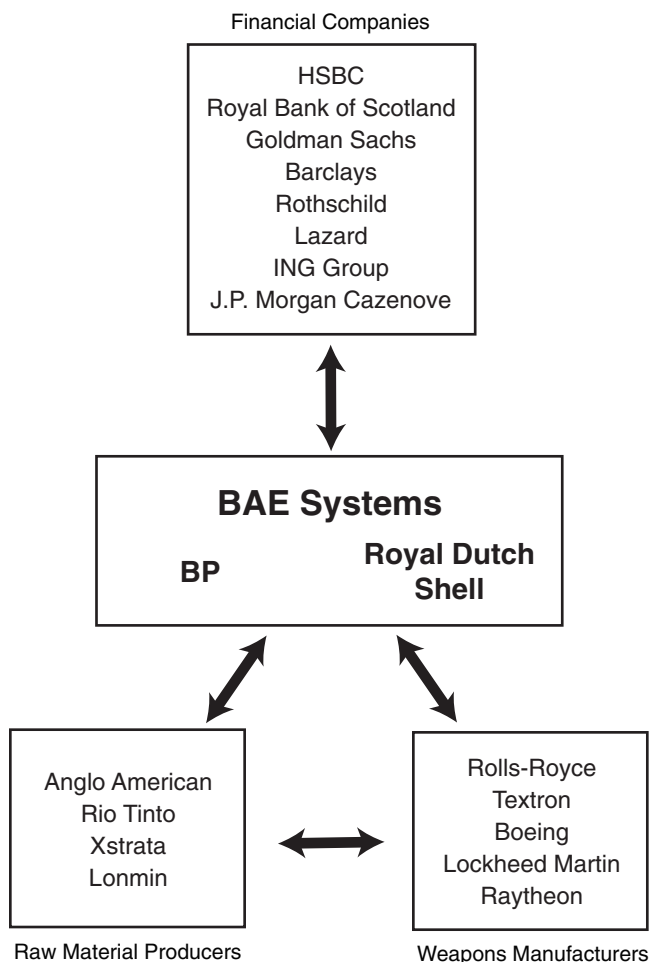

- BAE Director **Peter Weinberg** is a partner in the boutique investment bank Perella Weinberg Partners. Joseph Perella is a prominent mergers and acquisitions banker who was formerly a partner with current Lazard head Bruce Wasserstein. Weinberg is a former senior partner with Goldman Sachs, and the son and grandson of prominent Goldman Sachs bankers.

### A ‘Slime Mold’ of Interlocking Directorates

**Royal Dutch Shell**, the product of a union between British and Dutch petroleum interests, is one of the most important companies in the world, and a major player in Anglo-Dutch geopolitical maneuverings. Royal Dutch Shell’s World War II-era chief Henri Deterding was a notorious backer of Adolf Hitler, and the company’s banker in France, Lazard, was instrumental in creating Banque Worms out of a Shell-connected transport company; Worms was at the core of the Fascist Vichy regime in Nazi-occupied France. Royal Dutch Shell is even closer to the Rothschild banking interests, which

took a stake in the company in exchange for some Russian oil properties. Royal Dutch Shell has also funded cultural warfare operations against the United States and the rest of the world, including funding the creation of the environmental movement. Shell has current or recent interlocking directorship relationships with a host of companies of interest to this report, including Dutch financial firm ING Group and manufacturers Akzo Nobel and Unilever, Rio Tinto, Belgian raw materials powerhouse Société Générale de Belgique, U.S. aircraft manufacturer Boeing, and a host of financial firms including Lloyds TSB, UBS, AXA, and Aegon.

**BP** traces its roots back to the Anglo-Persian Oil Company, became one of the largest oil companies in the United States with the purchases of Amoco and Atlantic Richfield, and is the dominant oil company on Alaska’s North Slope. Several years ago BP dropped the name **British Petroleum** in favor of the initials, and now portrays itself as environmentally friendly. BP interlocks with Unilever, Akzo Nobel, HSBC, the Royal Bank of Scotland, Goldman Sachs, Rolls-Royce, Lloyds TSB, General Electric, Bank of America, Tata Steel, KPMG, GlaxoSmithKline, and Roche Holdings.

Many of these companies also have interlocks among themselves, and with other companies of interest. For example, Dope, Inc.’s HSBC shares interlocks with BP, Shell, gold producer Anglo American, the *Financial Times* and *Economist*, Cathay Pacific Airlines, Imperial Chemical Industries, pharmaceuticals giant GlaxoSmithKline, Rolls-Royce, the Kleinwort Trust, and investment bank Dresdner Kleinwort Benson. U.S. investment bank Goldman Sachs, which has historic ties to Kleinwort Benson, shares directors with both HSBC and the Royal Bank of Scotland. The Royal Bank of Scotland interlocks with BP, Goldman Sachs, Textron, Lloyds TSB, UBS Warburg, J.P. Morgan Cazenove, Swiss Re, mining company Xstrata, pharmaceuticals giant AstraZeneca, Citigroup, and the Prince’s Trust. Lloyds TSB and HBOS, the other two of the top five British banks, plug into this same network in multiple places.

This extended network is part of the oligarchical apparatus that Lyndon LaRouche has described as a “slime mold.” It is dynamic in that it changes with the times, absorbs or creates new parts while excreting the remains of decaying parts, while retaining its essential Venetian character and methodology. Individual parts come and go, but the slime mold itself lives on, absorbing as much of the world as it can.

In closing, we present the case of **Textron**, a major U.S. weapons contractor. One of the directors of Textron is Lord Powell of Bayswater, who, as Charles Powell, was private secretary and foreign affairs and defense advisor to British Prime Minister Margaret Thatcher. Now retired from government and made a life peer, Lord Powell, who was formerly with Jardine Matheson, is or has been an advisor to Rolls-Royce, private equity fund Hicks Muse Tate & Furst, Barrick Gold, and others. He is also the chairman of Sagitta Asset Management, whose principal investor is Wafic Said, a



Syrian-born British businessman close to the Saudi royal family, who is credited with helping set up the al-Yamamah arms deal. Another director of Textron is Lawrence Fish, the chief executive of Citizens Financial Group of Rhode Island, the tenth-largest bank holding company in the United States. Citizens Financial, in turn, is owned by the Royal Bank of Scotland, on whose board Fish also sits. In 1974, in a deal arranged by Lazard, Textron bought 45% of the ailing aerospace company Lockheed, and Textron CEO G. William Miller also became the CEO of Lockheed.

When it comes to the military-industrial complex and the Anglo-Dutch slime mold, it is a very small world.

## BAE, Baroness Symons, In Black Operations Against LaRouche

by Anton Chaitkin

As documented in the widely circulating broadside, “BAE Scandal Demands Cheney’s Immediate Impeachment” (see lead article in this section), Vice President Dick Cheney attempted to bury the BAE scandal in both Britain and the United States, precisely because investigation of this \$80-100 billion British/Saudi slush fund could reveal the authors of very “black” Anglo-American covert intelligence operations, amongst them 9/11. According to British and other news accounts, Cheney prevailed upon Prime Minister Tony Blair and U.K. Attorney General Lord Goldsmith to shut down the British Serious Fraud Office’s investigation of BAE, on “national security” grounds.

Ongoing investigations also shed new light on the role of Cheney crony Baroness Elizabeth Symons in covering up the BAE operation and in British black propaganda attacks on Cheney’s leading U.S. political antagonist, Lyndon H. LaRouche, Jr. Based on this background, it is hardly remarkable that Symons baldly proclaimed to Reuters news agency on Feb. 27, 2007, that the British criminal investigation of BAE was shut down because there was no evidence of bribery—“the reason they did not find anything is because there was nothing to find.” Symons’ attempt to bury the matter occurred just at the time that the cries of “coverup” were reaching a crescendo in the British press, and major investigations of BAE were developing internationally.

### An Imperial Inheritance

Elizabeth Symons was one of a handful of political operatives who shaped the 1990s rise of Tony Blair’s New Labour as a poorly disguised Thatcherism. Her father, Ernest Vize Sy-

mons, had been director-general of the U.K. tax department (Inland Revenue), and a governor of the English-Speaking Union, which sought to reunite the U.S.A. with the British Empire. When her father retired in 1979, Elizabeth began working in the trade union division of the Inland Revenue, and later in other unions, in an effort to emasculate the unions and separate them from political power.

In 1996, Tony Blair nominated Symons for a life peerage for having helped create a labor-free Labour Party. By this time, Symons had long been a Fellow of the British-American Project for the Successor Generation, a project to tie together British and American defense and secret services strategists. (This was begun by Sir Charles Villiers in 1985, when his son-in-law, John Negroponte, now U.S. Deputy Secretary of State, was boosting the Contras as Ambassador to Honduras.)

As Prime Minister in 1997, Blair appointed Baroness Symons to the post of Parliamentary Under-Secretary of State in the Foreign Office.

Symons represented the Foreign Office in the House of Lords in March 1998, when she was questioned about the coup and countercoup in Sierra Leone in West Africa. Executive Outcomes, a mercenary group tied to the British Crown, had moved a protection racket into Sierra Leone in 1993, taking its payoff in diamonds. When Ahmed Tejan Kabbah was elected President of the country in 1996, he acted on the encouragement of U.S. President Bill Clinton to cancel the British mercenaries’ contract, despite the Executive Outcomes threat that he would be overthrown.

A military coup then removed Kabbah; British High Commissioner Peter Penfold, in exile with Kabbah, successfully urged him to hire Sandline, Executive Outcomes’ partner mercenary company. Sandline shipped in 30 tons of arms, contravening the United Nations sanctions on arms to that civil-war-devastated country.

Sandline had fully informed the Foreign Office, and others in the Anglo-American black-operations chain of command. A Foreign Office official had told BBC on March 9, 1998, that Baroness Symons was in the circles that had been briefed on the transactions, and that she knew of the ongoing criminal investigation by British law enforcement.

On March 10, 1998, Lord Avebury, a Liberal Democrat in the House of Lords, asked Baroness Symons on the official record, would she investigate press reports that “the future diamond resources of the country have been mortgaged in an illegal arms transaction in which a British company, Sandline International, was involved?”

Symons denied all, obfuscating that “the newspaper article to which the noble Lord refers . . . was in several respects not entirely accurate, or at least not on all fours with the reports that Her Majesty’s Government are receiving.” There were then calls for Symons’ resignation, which Blair rebuffed. As BBC reported the same day: “The Prime Minister has leaped to the defence of foreign office minister Baroness Symons, at the centre of allegations that she misled parliament



*Baroness Elizabeth Symons, meeting with Russian Foreign Minister Sergei Lavrov in 2005. At that time, she was U.K. Minister of State. Symons wrote that it was necessary to “tread very carefully” to sneak BAE deals past the U.S. embargo against Iran.*

NATO

over the arms-to-Africa affair. Tony Blair told MPs ... that he had not asked her to resign and said there was ‘not a shred of evidence’ that she ... had deliberately misled anyone.”

### **The Cheney-Blair Axis**

In 2000, Dick Cheney, chairman and CEO of the Halliburton oil services company of Houston, Texas, and candidate for Vice President, was the American co-chairman of a British conference held April 14-16, on the subject of privatizing the British and American armed forces. This was the special project of Baroness Symons, whom Blair had appointed in 1999 as Minister for Procurement in the Ministry of Defence. The conference was attended by all the main Ministry of Defence officials working to implement her plans for military “Public Private Partnerships,” the “Smart Acquisition” initiative, and the “Private Finance Initiative.” The event was sponsored by the Rand Corporation, and hosted by the Ditchley Foundation, an Anglo-American power elite group in which Baroness Symons is a trustee and governor.

In his opening remarks to the conference, Cheney referred to his own leadership, first, as Defense Secretary (1989-93), in scheming to have private companies and mercenary soldiers usurp the traditional national military function, and then, steering his Halliburton company to play that role. Cheney said: “I have approached the question of privatization of defense support services from several different perspectives: first as a member of Congress, then as Secretary of Defense, and currently as chairman and chief executive officer of Halliburton.” He noted that “our British colleagues are far ahead

of us in ... successful privatization efforts.”

Cheney complained that a “challenge for DoD [Department of Defense] is to develop a strategy for countering political resistance. This conference ... provides a tremendous opportunity for us to share experiences, and to learn how the U.S. might take advantage of the concepts and principles that are embodied in the U.K. experience.”

Cheney’s personal appearance in England at just that moment coincided with Baroness Symons’ first planned big privatization: Martin Kitterick, a Defence Ministry consultant on Symons’ “Private Finance Initiative,” spoke to the conference on the scheme to turn transport of battle tanks over to private companies’ trucks and drivers, a contract that Halliburton wanted.

On April 17, 2000, the day after the Cheney-Ditchley conference, the Ministry of Defence announced Baroness Symons’ plan for privatizing the British government’s giant Defence Evaluation and Research Agency. Baroness Symons then led the parliamentary debate on the plan, reassuring the Lords that she was working closely with the Americans.

After the Supreme Court decision of Dec. 12, 2000, Dick Cheney was designated as Vice President and George W. Bush as President of the United States, to take office Jan. 20, 2001.

The announcement by Baroness Symons, that a consortium headed by the Halliburton company was awarded the £300 million contract to privatize military heavy transport, was graciously delayed until Jan. 24, after the inauguration. Cheney was then presumed to be out of the company, although his Halliburton stock options and continuing compensation

became an increasingly heated Washington topic.

While Cheney was in England, another British contract went up for grabs. The U.S. Lockheed Martin Corporation was bidding for the Joint Strike Fighter program. In 1994, just after Dick Cheney had taken the helm at Halliburton, his wife, Lynne, had become a Lockheed director, serving on the board's Finance, Nominating, and Corporate Governance committees. Lynne Cheney stepped down from the Lockheed board on Jan. 5, 2000.

On Jan. 17, just before Dick Cheney took power, Symons was in Washington. At the Pentagon she ceremonially signed Britain's commitment to the Joint Strike Fighter program. This Anglo-American venture was labelled "the largest defense procurement program ever conceived." The Defence Ministry announcement awarding British funds to Lockheed in the Joint Strike Fighter program came in October 2001, at a decent time interval from the Halliburton announcement.

On June 11, 2001, Baroness Symons moved out of the Defence Ministry, becoming simultaneously Minister of State for the Middle East, in the Foreign Office, and Minister of State for Trade, in the Department of Trade and Industry.

On July 1, 2001, just after Symons' departure from Defence, the shape of her overall scheme for a private power-and-money grab came before the public. The Defence Evaluation and Research Agency was split into a huge private firm, to be called QinetiQ, and a smaller residual government agency. In the next year, the Blair government shocked some people with the announcement that the Carlyle Group—the private equity fund tied tightly to the Bush family—was to be awarded a large stake in QinetiQ, the "public private partnership."

On Feb. 28, 2003, less than a month before the Cheney-Blair-Bush invasion of Iraq, the Carlyle group paid £42.3 million for a 34% holding in QinetiQ. When a large block of QinetiQ stock shares was later put on the public market, the Carlyle Group got about an eight-fold return on its investment. Among those reaping gold from Baroness Symons' planning was former Tory Prime Minister John Major, who had become European Chairman of the Carlyle Group while Baroness Symons was Minister for Defence Procurement.

## **BAE Intrigues, War Lies, and The Assault on LaRouche**

Baroness Symons' own machinations on behalf of BAE Systems began surfacing in 2005, when the *Observer* newspaper described her earlier intervention with her Washington circles. This had been in the Summer of 2002, when Cheney was driving hard for war with Iraq.

The story, as told by the British media, is that, at a dinner given by a neo-conservative professor, the Baroness sat next to Attorney David Mills, husband of Tessa Jowell, Blair's Minister of Culture, Media, and Sport. Mills had arranged a \$200 million deal with BAE Systems for the Iranian company Mahan Air to buy a fleet of passenger jets. Mills asked Sy-



*David Mills, had arranged a BAE deal for an Iranian firm, and asked Symons to intervene in Washington to get it approved.*

mons to use her influence in Washington to get around the U.S. sanctions law that would penalize a company doing that kind of business with Iran.

On July 9, 2002, ten days after the dinner, Mills wrote to Symons that "BAE will sell or lease as the case may be to [name redacted], a company incorporated in the UAE [United Arab Emirates] and majority-owned by UAE citizens for which I act. It is a condition precedent of the deal that there will be no US objection. It is my understanding, however, that the US government operates the embargo with a degree of discretion. I am sure HMG [Her Majesty's Government, that is, the Blair regime] will wish to offer such support as it can to smooth the path with our American friends, and I would be very grateful if you could do what you can to ensure that BAE get the help they will ... need."

Baroness Symons wrote back to Mills, "Given the obvious political sensitivities you will need to tread very carefully with this one. This is a difficult time to be raising Iran policy in Washington. The advice I have been given, with which I am inclined to agree, is that our official support for you with the administration would raise the profile of the case and, by so doing, increase the chance of eliciting a negative response. So you will need to think very carefully about a lobbying strategy calibrated to achieve the right result. I am pleased that Allan Flood [the BAE Systems director] will be in Washington next week and that he will be calling on the embassy to discuss this further. They are best placed to advise on next steps."

Nothing happened to the Baroness when this was published; David Mills was subsequently charged with money laundering and tax crimes (indicted July 2006) as a cohort of former Italian Prime Minister Silvio Berlusconi, an ally of the Cheney-Blair-Bush war axis.

That August, Dick Cheney was raving that Saddam Hussein was pursuing a nuclear bomb capability. The same theme



*Alastair Campbell, then press secretary for Tony Blair, helped coordinate strategy for selling the Iraq War in 2002, working with Symons' husband, Phil Bassett.*

was rattling around the Prime Minister's office, where Baroness Symons' husband, Phil Bassett, was a longtime Blair aide. From September 2002 until October 2003, Bassett was senior advisor and headed the Strategic Communications Unit at 10 Downing Street, the Prime Minister's office. It was there that Bassett helped pull together Blair's Sept. 24, 2002 "Big Lie" dossier claiming that Saddam Hussein had "weapons of mass destruction" ready to launch at 45 minutes' notice.

Bassett and government Press Secretary Alastair Campbell went to Washington in October 2002, to coordinate strategy for lying about the Iraq danger. With the White House, they established the Coalition Information Centre, which Tucker Eskew, Deputy Assistant to the President in the White House Office of Communications, then went to London to implement with Bassett and Campbell. This apparatus and MI6 continued to produce falsified Iraq intelligence as a pretext for war.

Then a factional brawl broke out in London and in the United States, with intensified opposition in leading circles against the Cheney-Blair Iraq War.

On April 3, 2003, two weeks after the start of the war, BBC interviewed Lyndon LaRouche on the "Live Five" show for six minutes, introducing him as a leading critic of the Iraq War policy, and as a candidate for the 2004 Democratic Presidential nomination. Two days earlier, the LaRouche campaign had released a quarter-million-run pamphlet, "Children of Satan: The 'Ignoble Liars' Behind Bush's No-Exit War." On June 9, 2003, BBC's "Live Five" interviewed LaRouche again, this time for 12 minutes, on LaRouche's recent call for Cheney's impeachment and on Cheney's role in faking Iraq intelligence—faking that Blair, Campbell, and Bassett had also done.

In between these two LaRouche interviews, BBC ran two stories (May 29 and June 2), using leading British government weapons scientist Dr. David Kelly as its source, charg-

ing that the propaganda team in Tony Blair's office had "sexed up" their Iraq-weapons dossier to make a better excuse for war. After being bullied during interrogation by Blair-controlled members of Parliament, Dr. David Kelly turned up dead, an alleged suicide.

The counterattack by the Blair-Cheney gang also aimed directly at LaRouche. In March 2003, Jeremiah Duggan, a British student studying abroad, committed suicide while in attendance at a Schiller Institute conference in Germany. The Schiller Institute has long been associated with the international economic development proposals of Lyndon LaRouche and Helga Zepp-LaRouche. German police and prosecutors thoroughly investigated Duggan's death and ruled it a suicide.

Baroness Symons, however, met on April 1, 2004 with Erica Duggan, Jeremiah's mother, announcing that she would appoint a lawyer to work with the Duggan family to pressure German authorities to reverse their assessment of the case. What has followed has been a lurid international propaganda campaign, alleging that Jeremiah was murdered or terrorized

## John Train and BAE

Ongoing investigations of the BAE scandal raise new questions about John Train's business associations. Train, a Wall Street banker and veteran of the CIA's Congress of Cultural Freedom operations in Western Europe, headed the intense 1983-86 black propaganda campaign of defamation against Lyndon LaRouche. Train utilized journalists and U.S. government operatives to defame LaRouche internationally, and remains active against LaRouche to this day.

BAE is currently attempting to get U.S. authorization for a buyout of Armor Holdings. The principal player in Armor Holdings is Burt R. Ehrlich. Until 2004, Armor Holdings owned Defense Systems Limited, a notorious British mercenary and black operations firm. Ehrlich had listed Smith Train, Counsel—Train's former investment firm—as his address on SEC filings.

Smith Train was itself partly bought in 1984 by the London-based English Associate Trust, a subsidiary of the Swedish firm PK Banken. PK Banken was run by Erik Penser, an official of the European arms cartel, Bofors/Nobel industries. Penser's role in dirty East-West arms deals was under investigation by Swedish Prime Minister Olaf Palme at the time that Palme was assassinated in 1986. As part of the deal between Smith Train and PK Banken, John Train was placed on the board of PK Banken. BAE took over Bofors in 2005 when the Carlyle group handed Bofors over to BAE.

to death, without a scintilla of factual evidence contradicting the German findings. The latest twist in the Symons-steered crusade is the Spring 2007 introduction of a resolution in the House of Commons, agitating for a new British investigation into the death of Jeremiah Duggan.

Since leaving her ministerial posts in 2005, Baroness Symons has been Tony Blair's Special Envoy to the Middle East, and to Saudi Arabia, standing as an inner-circle guard for the British-Cheney-Bandar relationship, and, by extension, the lucrative Al-Yamamah project. She is chairman of the British-Saudi Business Council, and vice president of the Middle East Association.

From her station in the House of Lords, she has chaired the all-party group on Qatar. That tiny Persian Gulf kingdom, bordering on Saudi Arabia, has just set up the Qatar Financial Centre, a projected speculators' paradise modelled on the City of London financial district. The BAE Systems company, shaken by mushrooming scandal and facing several potential U.S. investigations, has reached into Qatar to give itself hoped-for credibility. Lord Harry Woolf, the former Chief Justice of England, now works as "chief judge" in the Qatar Financial Centre, alongside Tony Blair's brother, attorney William Blair, who heads the Centre's regulatory body. BAE Systems has hired the Qatar-based Lord Woolf to head a panel of experts to decide whether the company is completely ethical, or needs sprucing up. On June 28, the Qatar Financial Centre sponsored a conference on the potential uses of the sea of money now washing through the hands of Britain's Persian Gulf clients. Baroness Symons was scheduled to chair the meeting.

Now officially in private life, although still Special Envoy to Saudi Arabia, and so on, the Baroness is a paid consultant to the Anglo-American law firm DLA Piper, long the attorneys for Halliburton. Recently her London DLA Piper office has been home base to Michael Lester, who had been general counsel and a director of BAE Systems from the year (1999) that Symons became Minister for Defence Procurement. He had been responsible for BAE's "ethical policies and principles." Lester's entry into Baroness Symons' firm was announced on Dec. 16, 2006—the day after the Serious Fraud Office dropped its investigation of BAE Systems.

**HOTLINE**

**LaRouche and EIR Staff  
Recorded Briefings  
—24 Hours Daily  
918-222-7201, Box 595**

---

## Crown Agents

---

# The British Monarchy's Direct Links to BAE

by Dean Andromidas

*Investigations into the apparatus which spawned the gigantic BAE-Saudi arms deal, have turned up a direct link to the British Royals. The connection runs into an "emanation of the Crown" called Crown Agents, a quasi-private arm of the Monarchy, that has handled a wide range of government support functions for British Crown Colonies around the globe from 1833 forward.*

*A definitive study of Crown Agents was published by EIR in 1997, and reprinted in EIR's Special Report "The Coming Fall of the House of Windsor" (available from EIRNS for \$75). We reprint that section below.*

*The specific point of continuity centers around Sir John Cuckney, who was brought in to reorganize Crown Agents in the mid-1970s. He spun Millbank Technical Services out of Crown Agents, into the Ministry of Defence, and also assumed responsibility as the chief advisor on overseas arms sales to the new Prime Minister, Margaret Thatcher. When put into the Defence Ministry, Millbank Technical Services takes on the name International Military Service (IMS), which is organized as a "private company" whose shares are owned totally by the Secretary of State for Defence!*

*From the Ministry of Defence, Cockney laid the groundwork for the Al-Yamamah deal, although he left in 1985, before the final negotiations were completed by his replacement, Sir Colin Chandler. Chandler himself came into the Defence Ministry from BAE Systems, where he maintained his post. At the Ministry he headed the Defence Export Services Organization, while chairing the IMS.*

### Crown Agents: The Queen's Managers

Crown Agents, officially known as Crown Agents for Overseas Governments and Administration, occupies a nondescript office block in Surrey, in the suburbs of London. According to its literature, Crown Agents is a not-for-profit, private corporation, which carries out mundane logistical and administrative sub-contract work for the British Overseas Development Administration, and various development agencies and foreign governments. This is typical British understatement—i.e., strategic deception.

Crown Agents is exactly what its name implies, an agent of Her Majesty the Queen. It was founded in 1833 as Crown Agents for the Colonies, and historically played a vital role in

the creation and management of what British historians call the Third Empire.<sup>1</sup> While Lord Palmerston, Cecil Rhodes, Prince Edward Albert (“The Prince of the Isles”), and Lord Milner were providing the geopolitical theory and ideology to justify Britain’s global empire, Crown Agents ran the day-to-day affairs. Crown Agents printed the stamps and banknotes of the colonies; provided technical, engineering, and financial services; served as private bankers to the colonial monetary authorities, government officials, and heads of state; served as arms procurers, quartermasters, and paymasters for the colonial armies. In effect, Crown Agents *administered* the British Empire, which at one point in the 19th Century, encompassed over 300 colonies and nominally “independent countries” allied to the British Crown.

According to its charter, Crown Agents is an “Emanation of the Crown.” This gives Crown Agents a status close to the monarchy, yet outside the official government structures of the United Kingdom. Through much of its existence, it was overseen by the Colonial Secretary and, later, in the so-called post-colonial era, by the Minister of Overseas Development. Although not formally a department of the government, Crown Agents’ entire debt was *guaranteed* by the Exchequer.

In 1996, as the British were in the process of unleashing the dogs of war in Africa, as the cutting edge of its final assault against the nation-state system worldwide, Crown Agents was “privatized,” under the new name, Crown Agents for Overseas Government and Administrations Ltd., with its own board of directors and management. In turn, Crown Agents functions as a holding company for dozens of operating companies and joint ventures. Its shares are held in trust by the Crown Agents Foundation, which is presided over by a board of directors and councillors, bringing together an impressive collection of governmental and non-governmental organizations, corporations, banking and business organizations, and so on—all from the inner core of the City of London Anglo-Dutch financier oligarchy and the formal Crown apparatus.

### Providing Functions in ‘Difficult Areas’

According to its 1996 annual report, Crown Agents’ numerous subsidiaries still carry out the same wide array of governmental functions, from printing postage stamps and bank notes, to running worldwide commercial shipping and air

---

1. In an unofficial history of Crown Agents, written by a former Crown Agent and published privately in 1958, the author talks of three distinct British empires. The First Empire, according to this account, began in the first half of the 16th Century as a by-product of England’s wars with Spain, and lasted until the American Revolution, which left England in an extremely weakened position, both as a colonial and a European power. Nonetheless, the period between the end of the American Revolution and the end of the Napoleonic wars, is considered the era of the Second Empire, which included the consolidation of Canada and expansion in Asia and Australia. The Third Empire is dated by the founding of Crown Agents in 1833, and is marked by the expansion of the Empire throughout Africa and the Indian subcontinent. This is the empire of Cecil Rhodes, Lord Milner, et al.

freight operations, to procuring arms and other logistical supplies. Crown Agents, according to spokesmen, specializes in providing these functions in “difficult areas.”

And, indeed they do. Today, Crown Agents functions as “agents” for over 150 foreign governments and organizations, which they refer to as “principals.” In some instances, they manage vast real estate and financial portfolios, specializing in offshore banking “services.” According to its recent public statements, Crown Agents manages over \$3 billion worth of projects. Its asset management business alone, has a portfolio valued at over \$1 billion.

---

---

*Crown Agents functions as “agents” for over 150 foreign governments and organizations, which they refer to as “principals.” In some instances, they manage vast real estate and financial portfolios, specializing in offshore banking “services.” According to its recent public statements, Crown Agents manages over \$3 billion worth of projects. Its asset management business alone, has a portfolio valued at over \$1 billion.*

---

---

Typical of Crown Agents’ current “discreet” operation are the following:

- It manages the entire customs service for the government of Mozambique;
- Through its chairmanship of a quasi-public entity called Europe SA, it is in charge of all economic reconstruction procurement for Bosnia;
- Through a joint venture with a Monaco-based company called ES-KO, Crown Agents provides all of the food for United Nations peacekeepers in Angola and Bosnia. ES-KO also provides logistical services to private petroleum and mining companies in such “difficult” areas as Algeria and Colombia, and manages the privatization of the state sector of Ghana.

### Her Majesty’s Murder, Inc.

By now, it may have dawned on some readers that Crown Agents’ range of “services”—arms procurement, border controls, offshore banking—also nicely fit the “administrative requirements” of the world’s organized crime cartels.

In fact, a careful review of some of the more sordid aspects of the recent history of Crown Agents, suggests that the firm has been at the center of the British Crown’s highly sensi-

tive patronage of global organized crime—what *EIR* long ago dubbed Dope, Inc.

Crown Agents' extensive links to international organized crime surfaced in the mid-1970s, when the firm's over-extended real estate portfolio, particularly its London real estate investments, blew sky high. At the time that the London commercial real estate market collapsed, Crown Agents was managing a portfolio of assets, loans, and other financial paper, totalling more than £4 billion. Despite the fact that Crown Agents held no banking charter, it owned a string of banks all over the world, including some unsavory outfits in some of the most notorious hot-money havens of the Commonwealth.

Much of the capital through which Crown Agents built up its real estate portfolio came from Third World governments, which made the unfortunate mistake of placing their trust in the Queen's favorite service agency. Crown Agents heavily leveraged its investment capital, building up debts far beyond its resources. When the 1973 oil shock hit, and the real estate market was one of the first of the bubbles to pierce, Crown Agents, along with many other institutions that were heavily leveraged in the secondary banking markets, went broke.

The Bank of England stepped in to bail out Crown Agents to the tune of several hundred million pounds—more than a decade before the U.S. government would carry out a similar bailout of the savings and loan institutions, ravaged by similar commercial real estate speculation. The collapse of Crown Agents' real estate portfolio led to three governmental and parliamentary investigations.

The surfacing of a wide criminal conspiracy was averted with the timely death of one of the key witnesses, the director of Crown Agents' money market operations, who purportedly blew his brains out shortly before he was to face trial on charges of corruption. According to news accounts at the time, this fellow, whose signature appeared on many of the most outrageous transactions, happened to be a heavy gambler. He had been a member of Crockfords, an elite gambling club, and two other casinos. He was a fixture at London casinos, often signing £1,000 checks. He had a home in Westminster, one of the most expensive sections of London, a country house, and three cars—all on a middle-level civil servant's salary of £5,000 a year.

### **Part of 'Organized Crime'**

A look at a sampling of Crown Agents' business partners at the time of the real estate blowout, is revealing.

Crown Agents, up until 1983, managed the personal fortune of the Sultan of Brunei. The latter has been a funder of all sorts of private projects of Prince Philip and Prince Charles, as well as funding British intelligence operations all over the world. The Sultan was one of the key financiers of George Bush's Iran-Contra operations. So large was the task of managing this fortune, that when the Sultan withdrew his £3.5 billion, Crown Agents laid off 400 employees.

Crown Agents provided the capital for a number of off-shore banks, especially during the 1960s and 1970s. One such bank that enjoyed the financial backing of Crown Agents was Trade Development Bank, then owned by Edmond Safra. A member of Prince Philip's 1001 Club, Safra was a prime target of investigation by U.S. drug enforcement agencies for many years. In 1990, his flagship New York City bank, Republic National, was identified as a favorite laundromat for both the Medellín Cartel and Lebanese-based heroin and hashish smugglers.

It not only lent to banks of dubious origins, but held controlling interests in them as well. In 1967, Crown Agents bought a 40% controlling interest in the Bahamas-based E.D. Sassoon Bank. This was the first of a network of banks it invested in, or created, throughout the Commonwealth. This bank was founded in the 19th Century by Sir David Sassoon, who founded banking houses in India and China, where they made their fortunes in the opium trade. The bank moved to the Bahamas in the 1940s, at precisely the point that the British Crown colonies there were being built up as hot-money centers. In 1967, it was controlled by Ralf Yablon, whose mother was a Sassoon. Yablon's wife was the daughter of Max Joseph, who at the time owned the famous Grand Met casinos. The other shareholders of the bank were Continental Illinois and Franklin National Bank. So dubious was the reputation of this bank that even the Bank of England initially refused to give its blessing to its purchase by Crown Agents. When the big bust occurred in the 1970s, E.D. Sassoon Bank was absorbed by the giant Standard and Chartered Bank, which now sits on the Crown Agents Board of Councillors.

The most notorious property investment was with the Stern Group of Companies, controlled by William Stern. It was his personal bankruptcy in the early in 1970s, at the time the largest in British history, that triggered the run on Crown Agents. Stern was an American businessmen, with tight business connections to Murder, Inc. boss Meyer Lansky. The Stern-Lansky ties ran through the National Crime Syndicate boss's most trusted bag man, Sylvain Ferdman. Ferdman was identified in a 1967 *Life* magazine exposé of organized crime as Lansky's liaison to a number of leading Swiss banks implicated in the crime boss's global money-laundering operations. Indeed, Stern fit right into this picture. His brother-in-law at the time was Tibor Rosenbaum, whose International Credit Bank (BCI) was exposed in the *Life* magazine story as a Lansky front, which also serviced the covert financial needs of the Israeli Mossad. BCI went bust at the same time that Stern's bank and Crown Agents fell. Stern's personal bankruptcy was intimately linked to the collapse of BCI, where he had invested over £1 million—which, in turn, he had gotten from Crown Agents. The bailout of Crown Agents, and the mysterious death of its chief lending officer shut down any further probe of the Crown's links to the Lansky syndicate.

By the end of 1974, the Crown Agents collapse was, nevertheless, Britain's most serious financial scandal.

To clean up the “loose ends,” and maintain Crown Agents’ services to the Crown, Sir John Cuckney, a former high-ranking official of MI-5, was brought in as Senior Crown Agent. Cuckney had already left Her Majesty’s Service to become the “City’s” leading private spook, in the employ of Lazard Brothers. As soon as he took up his post at Crown Agents, he carried out a “reorganization”—i.e., a cover-up of the scandal. He also set the stage for Crown Agents’ subsequent emergence as a leading arms trafficker.

In 1974, as one of his first acts as Senior Crown Agent, Cuckney transferred Millbank Technical Services, the Crown Agents’ weapons procurement subsidiary, to the Ministry of Defence. He then consolidated its international networks of legitimate and not-so-legitimate banks and financial institutions, into what later became the Bank of Credit and Commerce International. BCCI, which former CIA Director Robert Gates [now, Secretary of Defense—ed.], in Congressional testimony, dubbed “The Bank of Crooks and Criminals International,” was at the center of the Golden Crescent (Pakistan, Afghanistan, Iran) opium trade, which flourished during the 1979-89 Afghanistan War. BCCI’s collapse in 1991 was the biggest financial blowout in modern history, with over \$20 billion in bank assets disappearing into thin air.

In 1978, having completed the restructuring of Crown Agents, Cuckney left to become a director of Midland Bank,

where he soon established a new international division, which engaged primarily in financing international weapons deals. When Margaret Thatcher moved into 10 Downing Street, Cuckney became a leading advisor to the Prime Minister. He was rewarded for his services by being made Lord Cuckney of Millbank. The “Millbank” in his title referred to Millbank Technical Services, which he untangled from the Crown Agents scandal.

### Crown Agents Today

Crown Agents’ British media apologists claim that the firm has been “reformed,” and is now a shadow of its former self. There is no evidence to support this claim. Crown Agents was organizing covert weapons shipments into Africa well into the 1990s, helping to fuel the recent genocidal warfare in the Great Lakes region, and abetting the butcher Yoweri Museveni, in Uganda. The current chairman and Senior Crown Agent is David H. Probert. Probert has been with Crown Agents since 1981. During this period he sat on the board of directors of the Birmingham Small Arms Company, one of the most famous weapons manufacturers in Britain. Another one of his directorships was with a company which reportedly held a majority stake in Defence Systems Limited, one of the preeminent British “private” mercenary outfits, now running around Africa and Ibero-America.

#### EIR SPECIAL REPORT

# The True Story Behind The Fall of the House of Windsor

Reprints of EIR’s 1994-1997 groundbreaking exposés

What political battles lie behind the assassination of Princess Diana?  
 Why do 22 out of 30 top terrorist groups have their headquarters in London?  
 EIR’s series on the House of Windsor is indispensable for understanding today’s news.

- The Coming Fall of the House of Windsor** (Oct. 28, 1994)
- The Sun Never Sets on the New British Empire** (May 24, 1996)
- Britain’s “Invisible” Empire Unleashes the Dogs of War,** (Aug. 22, 1997)
- Epilogue: Can the House of Windsor Survive Diana’s Death?** (Sept. 12, 1997)

Order from:

**EIR News Service**

P.O. Box 17390 Washington, D.C. 20041-0390 Order number EIR 97-004 **\$75**





# LaRouche Challenges Youth: Make a Revolution in Science

*Here are Lyndon LaRouche's opening remarks to a LaRouche Youth Movement cadre school held in Purcellville, Virginia, in which LYM chapters in Los Angeles, Oakland, Seattle, and Hackensack, N.J., in the U.S.; Montreal; Paris, Lyon, and Rennes, France; Stockholm, and Melbourne, Australia participated by conference call. Two hours of discussion followed. The complete audio archive is available at <http://wlym.com/tiki/tiki-index.php>*

Well, I did something the other day, you may have noticed. You may have noticed and I shall do a little appropriate *nachtsich* now, over the issue.

The crucial thing, which has several implications. First of all, those who've been down in "The Basement"—The Basement is the stairway to Heaven. You get to meet the most interesting cats down there. The meals are tremendous! And the conditions are absolutely wonderful, because it forces you to rely upon your imagination. Therefore, it forces you to think.

Now, the key thing is to be understood, and actually you probably noticed, that what's happening in The Basement, since particularly Kepler I, has radiated throughout the organization as those who read this material or discussed it, or it's been discussed, circulates more and more throughout the organization. And you find that what's being developed in the organization, especially among the youth in particular—some guys are hard of hearing, you know, when they get past the age of 40 and old age sets in—that there is actually a different culture developing in the leadership of this generation within the organization, a culture which is intrinsically superior to that of the general culture of the earlier generations.

The earlier generation, especially the Baby-Boomer generation, is problematic. It has no inclination towards science, as a generation—none. It has an inclination toward gambling, and mathematics as an art of gambling. But it does not have a sense of physical science, of reality—it has no interest in it.

Because, to them, the Boomers in particular, the restrictions of scientific thinking are just against their ethics. It's restrictive. "I would like to make up my own mind. I don't want *science* telling me how the universe works. I want to make up my own mind, my own opinion, my own little opinion. My circles, we may not agree with this stuff." And therefore, they are hostile, as we saw this in '68, especially hostile to science, hostile to any form of Classical art, which they consider an encroachment upon the right to freedom: The freedom *not to think*.

So, what you observed probably the day before yesterday [LaRouche's June 21 international webcast], is, the problem for the audience in general was a certain, "this science stuff." It's a problem. And yet, we saw that the connection between the politics and the science as I presented it day before yesterday, is essential.

## **Approaching the Stars from Below**

Now, take this one example, which is probably the best example now, because most people have been exposed to this work from The Basement, working your way from the bottom up, approaching the stars from below, is this idea of gravitation, the principle of gravitation which is exemplary of the fundamental principle of all competent science: That you have a principle in which the apparent infinitesimal is the most powerful force in the universe. That gravitation is expressed in the form of an infinitesimal interval of action. And that is why I laid it out the other day again, just briefly though: that the pathway of the Earth through its orbit, and that of other planets, is not determined by the image of some orbit: The orbit does not determine the pathway of the planet; the pathway of the planet determines the orbit. And this comes up now for those who are wrestling now with the Gauss determination, in which the motive is crucial. It is not the orbit that determines the pathway, which is what was the mistake of all



EIRNS/Stuart Lewis

Lyndon LaRouche addressed the LaRouche Youth Movement on four continents June 23: “We’ve come to a time in the history of the world, the history of the United States in particular, that the existential question, the essential existential question, is the immediate question before humanity.”

observers, but for Gauss, in that period. But, rather, it is the pathway as such, which determines the orbit. And that’s how Gauss was able to solve that problem. Which you will learn, properly, from the right group of people, when they finish their work, in the coming weeks and months.

And, this is true of everything: an *infinitesimal*! The most powerful thing in the world is an infinitesimal. The most powerful thing in the universe, is an infinitesimal! Or comparable things, which are also infinitesimals.

So, science is essentially—competent science—is the study of infinitesimals. Also, art! All competent art, is also based on the concept of the infinitesimal, not on the basis of naïve sense-certainty. And this is where the problem lies. And this is where, in the LYM, in the seepage of the effects of this work in The Basement, and related things, a culture is building up within the generation now, or within the core of the generation, a culture is building up which is beginning to think almost instinctively in terms of the infinitesimal, as the most powerful force in the universe; as opposed to the thinking about sense-certainty as the origin of truth. What you learn from science, the fundamental thing you learn from science from the beginning, of competent science, is that what you see, is not what is; what you hear, is not what is; what you smell, above all, is not what is.

So therefore, the distinction is, is also the same distinction of the concept of immortality: There’s no animal which is ca-

pable of thinking, in scientific terms—none. Because the human mind functions in this domain of the infinitesimal. No animal knows a universal physical principle! They know a habit. They know a conditioned habit. They know how to build on combinations of habits, by reacting, by combining habits, new habits and old habits, always operating on the basis of *sense-certainty*, as the map which they use to guide themselves in life.

When the animal dies, the animal’s dead. The animal kingdom does not change, in terms of its behavior, as a result of those animals which have died. They simply adapt to their animal nature, or the nature of animals within their domain. Human beings willfully change the behavior of the human species as a whole, with respect to the universe. Human beings willfully change the behavior of mankind, in such a way that mankind increases mankind’s power to exist in the universe, and control it. No animal can do this.

Now, this is the central question of all human knowledge; it’s this essential *existential* question, which most people in the older generation have no sense of. And even people who are scientifically trained and would be competent, in the sense of plumbers being competent at plumbing, they’re competent at science, in those terms, and are able to think in those terms of practice. But on the fundamental question of what is a physical principle, a universal physical principle, there are very few people alive today, who are considered specialists in

the domain of physical science, who have any comprehension of the principle I stated in discussing the question of the orbit around the Sun by the Earth, during that conference, my presentation Thursday—none! Therefore, they're not competent in science. Because they're incapable of grasping the most powerful thing in the universe, which is expressed as the smallest thing in the universe: the infinitesimal, the smallest existing thing in the universe.

### The Infinitesimal vs. Sense-Certainty

And the concept, of course, of the infinitesimal, as I think, many of you have either gone through it directly, or indirectly: of what the significance of the infinitesimal is, in respect to the Solar orbit of the Earth in the Solar system: Is that, no matter how much you divide the orbit into smaller and smaller intervals, the orbit is always going through a change in direction. And it's this constant change in direction, which persists no matter how small you attempt to go, which is actually the force, the motive which is determining the orbit.

So therefore, you draw an ellipse—[dumb voice] “that's the orbit!” It is not the orbit! That is the footprint of the orbit, not the orbit. Like a woman marries a guy's footprints. Not a very fertile idea.

It is not the footprints that are reality; it's that which *produces* the footprints, that is reality. It is the motive which produces the orbit, which is the reality of the orbit: *It is the principle that governs that motion, which determines the orbit.* And when you try to catch the orbit in your hand, it gets smaller and smaller and smaller, and you call it infinitesimal, because no matter how small you try to make it, it's always changing. Just think about this simple thing about the Keplerian orbit: To understand what it does: It's the principle of constant change. And every other kind of orbit. And in physical science in respect to every principle, it's always the same.

So, science is the study of infinitesimals; it's the study of that which controls behavior in the universe, in the smallest imaginable degree. The constant change in direction, the constant change in velocity—constant. So, there is no point at which the division becomes meaningless. And this is, of course, what Cusa discovered, in refuting the fallacies of Archimedes on the conception of the quadrature of the circle. There is no significant mathematical quadrature which can adduce a principle from a trajectory of a principled form of physical action.

Therefore, *this change*, this change in the way of thinking, this change to what has been known throughout the history of European civilization since ancient Greece; this principle of change is the essence of scientific knowledge, as the *essence* of the question of truth, as well as scientific knowledge. And that's what I concentrated on, in a small part, on Thursday, but



*“Competent science is the study of infinitesimals. Also, art! All competent art, is also based on the concept of the infinitesimal, not on the basis of naïve sense-certainty,” said LaRouche. Wilhelm Furtwängler, conducting “between the notes.”*

that's what's most crucial. And that's the characteristic which must distinguish the leadership of your generation, from the failed leadership of the preceding generation. This understanding of the infinitesimal.

It comes up; for example, it came up beautifully in the Kepler II project, where the question of harmonics was the confrontation. And I saw a lot of wrestling with good fun among the people who were going through that phase on the question of harmonics, as we began to talk about the relationship among the planetary orbits, and the relationship of those from the Sun. Suddenly, it's apparent. And then you look back at history, and it was *always* apparent in European civilization. From its Pythagorean, and related roots, it was always obvious: That the senses do not determine—do not *lead* you to an *understanding* of the causal features of the reality within which you're living.

For example: In formal mathematics, what is usually taught is corruption, how to be stupid. And this is sometimes called Euclidean geometry. You're told, [stuffy] “We must begin with certain self-evident principles!” “We must have—

definitions! We must have axioms, axiomatic assumptions. And we have postulates,” to clean up the mess afterwards. “Only then! Only then, dare we presume to say we know something.”

Now, the point is, in the first instance, the first approximation of this is vision. We have *sense-certainty*: “What I can see!” What I can see. Then you have a different sense: What I can hear. And we have another sense: What I can touch. And how I can smell, which has interesting connotations.

So therefore, people start with what they consider *a priori*: what is common knowledge; what is generally acceptable common knowledge. Sight? Sound? Touch, and smell.

So therefore, you say, “It is self-evident!” What does it mean, “self-evident”? It means, it is evident to this particular sense to which we are referring. It’s evident to the habit of seeing; it’s called vision; the habit of hearing, which is called harmonics and sound. The experience of touch, and the experience of smell. Each of these becomes then a self-evident definition of experience, and we’re trying to “interpret” experience. So we start by respecting the experience itself. What is experience? Sense-perception!

Now, how the hell do you know anything from sense-perception? What kind of a fraud is it you’re trying to perpetrate by saying that sense-perception tells you something? What is sense-perception? It’s simply a reaction of the body as a whole, to certain things that impinge upon it from outside. The impinging is detected by sense-perception organs, which are nothing but living, biochemical organisms, and these things are translated to the human brain, and they’re interpreted by the brain. So therefore, the existence of the human being and human knowledge seems to be determined by the completely internal, to the living organism, and it reacts to things which touch upon it from outside. But how does it know, that that which touches it, which causes a sense-perception—how does it know that that represents anything true?

Now, in what’s called Euclidean geometry, which is a complete hoax anyway, you’re taught to look at everything from what? From the standpoint of the assumption of a linear universe of sense-perception: Straight line interception of the universe with the sense organs and mind of the individual. That’s fine, okay. That’s called Euclidean geometry, which is a fraud. Because, these are sense organs, like any other instrument, even like an electromechanical instrument in electronics: The instrument doesn’t “know” the universe around it. The instrument is a method of *response* to the universe around it. And when you design instrumentality, you better not assume that the universe is what the instrument thinks it is. Because, then you’ll result in a disaster. You have to know what the universe is, *despite* the fault in communications given to you by any one kind of sense-perception.

### How Do We Know the Universe?

Now, that gives you a hint: How can the human mind actually know the universe? Well, it can know the universe by



*“In formal mathematics, what is usually taught is corruption, how to be stupid. And this is sometimes called Euclidean geometry.” Shown here: Euclid, working on his definitions, axioms, and postulates.*

changing its own circumstances of existence, by acting on the universe. Now, how do we know what the universe is? Well, we start with sense-perception. But what do we do? We don’t rely upon sight, or sound, or touch, or smell. We rely upon *none of these, as individual senses*; or even a simple combination of them. We rely upon a practical understanding of the *falsity* of what any of these senses show us to be.

Now, the easiest way to do that, is to look at the relationship between sound, and sight. You have to smell the universe, not just look at it. And that’s exactly what Kepler does! Exactly what he does, especially when it comes to what we call—here, among us cognoscenti—“Kepler II.” We do not rely upon sight, or sound, or smell, or touch: We rely upon that which is true, which is none of those. We rely upon the paradoxes, the contradictions between the view of the world suggested to us by any one sense, and the primary experience is that of the relationship of sight to sound.

Now therefore, the reaction you get, and the first reaction you get, even from so-called trained scientists of the type we used to have around back in the 1970s and early 1980s, those who were associated with the Fusion Energy Foundation; the fight we had was on this issue. And the biggest explosion that ever occurred in the Fusion Energy Foundation on any issue, is when I raised the question of Kepler, because the question of Kepler’s organization of the Solar system. And that produced howling and squealing. It was amazing—like a banshee convention suddenly broke out around the table.

What is the significance of this Kepler II? What is the difference between what Kepler accomplished in the first instance, in determining the relationship of Mars, Earth, and Sun, as opposed to determining the relationship of the Solar system to the Sun; and the relationship among the components and elements of the Solar system to the Sun. As then, it’s complicated by the introduction of this question of asteroids, which force you to go to another step of correcting assumptions.



Johannes Kepler (1571-1630). "Look at the relationship between sound, and sight. You have to smell the universe, not just look at it. And that's exactly what Kepler does!"

What it demonstrates is, that *harmonics*, as we think of harmonics in terms of Bach's well-tempered system, and that kind of counterpoint, is actually determining in the relationship of the planetary orbits, their definition, and the relationship among these orbits with respect to the Sun. So therefore, you have to combine sight and sound, in respect to their most contradictory aspects! No longer can you take a Cartesian view, or quasi-Cartesian view, and measure the relationships, the observed relationship among Solar bodies! You will never understand how the Solar system is organized! As our young geniuses of Kepler II discovered for themselves. It's when you realize that harmonics, in the sense of the musical harmonics of Bach's well-tempered system, and the approximation of this, only when you see the Composer of the universe—not just the Creator, the Composer: the Super-Bach—who has ordered a universe such that it does not correspond in its behavior either to deduction from sight or from hearing, but only from looking at the contradiction between the two, and finding a lawful meaning in that contradiction. And then, being able to practice, in the universe, to introduce changes in the behavior within the universe, by applying that discovered principle, as a law, as a guiding law to act upon the universe.

So, you do not know truth by sense-certainty. You know truth by sense-*uncertainty*! What you feel, is never true.

Then, you have to find out, somewhere in the contradictions of one sense to the other, what the universe is and what the principles are. *Then, prove*, that those principles you have *thus* discovered, are actually the more efficient means, of controlling the behavior of the phenomena to which you are attaching the powers of sense-perception.

The same thing is true in instrumentation. When we develop instruments, like electromagnetic instruments, to explore the atomic domain, we are developing instruments, which are designed as extensions of the concept of sense-perception. So, mankind invents new sense-perception instruments and applies these to the atomic or subatomic domain. And thus, by applying these instruments, we create *new* sensory experiences. Derivative sense experiences.

In this area, we arrive, again, into contradictions! For example, the greatest case in the 20th Century was that of Max Planck. Max Planck, in dealing with his paradox, which became the Planck quantum principle; it was not quantum mechanics. And the idiots try to reduce it to quantum mechanics, and they screamed and they howled about that. But what he discovered, was a *contradiction* in the use of extended forms of sense-perception to explore the universe, and found in certain domains, there were characteristics for which he proposed new views of what universal physical laws are.

So therefore, what you saw, what we touched upon on Thursday, in dealing with this question of gravitation, was the fact, that you think you *see* the orbit of the Sun; you think you can *measure* it. You try to eliminate the small differentiations, and say, "We can *generalize* this experience. We can find a principle which generalizes it from the standpoint of vision." But then, when you look at the planet as a whole, and you look at the inferred history of the Solar system, of coming from a solitary fast-spinning Sun, into a system of planets, now suddenly you're faced with: this no longer corresponds to reality. And that's why we divided the thing as Kepler did, between the Kepler I and Kepler II: That you look at one stand, you're looking at the relationship of the Earth, with respect to Mars and the Sun. You have a substitute for sense-perception. You discover there's an irony in that. And you work on that.

Now you think you've become the world's greatest genius. Then you go into the question of the relationship of the ordering of the planetary system with respect to the Sun, the planetary system as a whole, including the relationship *among* the planets. And suddenly, your sense-perceptual image breaks down. Now, you have a new experience, a new way of looking at the universe. And it is going on and on. And this is true in all experience.

For example: Let's take the most fundamental one. People say, "Well, there's the universe." They think of it as an extended BLA-A-H-H. Just out there. We're all swimming in it. It's a swimming domain of sense-perception. And then you discover that you can not derive the behavior of living processes,

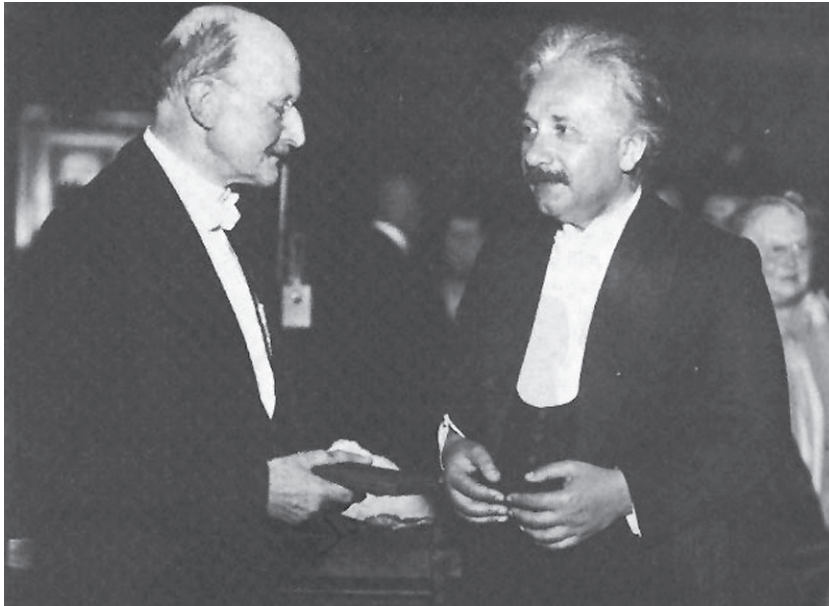

*Max Planck (left), with his good friend and collaborator, Albert Einstein: Planck discovered “a contradiction in the use of extended forms of sense-perception to explore the universe, and found in certain domains, there were characteristics for which he proposed new views of what universal physical laws are.”*

their characteristic behavior, from non-living ones! Can't be done. And this was explored by a number of people, but most notably from Pasteur, who posed the problem as a question—not as an answer, but as a question—into what followed: the recognition that life is a principle in the universe, which is not contained within assumptions derived from non-living processes. Life is not an evolutionary product of non-life. Because the behavior of processes in the universe, including chemical processes, atomic processes, in living processes, behave differently than in non-living processes.

## **The Principle of Life**

Now, it even gets more interesting. Because, if you look at the history of the Earth, from what can be inferred as its origin as a Solar object, you find an Earth which is, apparently, completely inorganic, non-living. But then, you have the emergence of living processes, fairly early in the game, which tends to suggest to you that the principle of life was there all along—you just didn't see it, you just didn't discover it. But then, you look at the history of the planet from the standpoint of archeology, and from the standpoint of physics in general, and you find that the products of living processes, *and* living processes as such, are occupying a constantly larger ration of the total mass of the Earth!

For example: The atmosphere is a creation of living processes. The atmosphere is not, shall we say, a natural non-living process. Doesn't exist. The atmosphere is created by the action of life itself as a principle upon the Earth. The oceans, similarly, are products of that: water, in its fossil form.

Now, we look at the planet as a whole; we take the average

mass of the planet, planet Earth. Ignore the fact that we're getting new material dumped on from the Sun all the time. We're the great trashcan for the Sun in our vicinity. Anything it finds in our vicinity, “there's a trashcan; it's called Earth—dump it there.” And that's what sort of happens to us. Now, you find that this principle of life, is not only something you can not adduce from non-living processes, but *life* is taking over a larger and larger percentile of the total mass of the Earth.

Then you come to the matter of human behavior. [Silly:] “Well, man is an animal.” Engels called himself an ape—and he probably was. Or, at least he was working hard to turn himself into one. But you find out that human behavior—and you look at the standpoint of ecology, simple animal ecology—human behavior does not correspond to animal ecology. Human populations do not conform lawfully, as lawful processes, to animal ecology: Because the animal ecology has a range of behavior, depending upon its

environment and the interaction among different species. *But!* The increase of the potential relative population density of the human species goes far beyond anything that any animal could ever accomplish—any animal or combination of animal species could accomplish.

So, life itself, as defined by animal species and similar kinds of things, is not the determinant of Earth; not the determinant of the Biosphere. That the great changes—look, if we were great apes, which some of our Baby Boomers tend to be, when they monkey around with man's future, we would have a fixed potential relative population density, just like any animal, any species of animal; variable under conditions and so forth, but nonetheless, it's not within our control, it's in the control of the biology of the system. And the relationship among species changes, the conditions of life change, and the species' population is controlled that way.

But with human beings, no. With human beings, who have the physical capabilities generally, which we associate with the higher apes, and all the other qualities of a higher ape, somehow human beings are not limited, to aping one another (unlike some Baby Boomers who specialize in that). Human beings have a willfully increased potential population density. Whereas the potential population of the gorilla, the mountain gorilla for example, or the forest gorilla, has a relatively fixed population density. And the chimpanzees, too. Humanity—this is in the order of millions in potential population. And the conditions for this population potential go back at least 2 million years, in terms of our knowledge of the conditions of this planet during the last 2 million-year-long series of ice ages, glaciations. Therefore, mankind, reaching beyond a popula-



EIRNS

*How did the human species achieve a population today of 6.5 billion people? “The principle of mentation, the principle of creative discovery, changed mankind’s character and behavior.” This “process of change is what we would call ‘intellectual.’” Shown here, LYM scientists Peter Martinson and Tarrajna Dorsey working with a Kepler model, in The Basement.*

tion of millions, or even tens of millions, or hundreds of millions, which by then, far exceeds anything that a higher ape could do—suddenly, now today, we have 6 1/2 billion people, or more than that, on this planet.

How’d we get there? The principle of mentation, the principle of creative discovery, changed mankind’s character and behavior. But these changes in mankind’s character or behavior, are not changes *upon* mankind; they’re changes *within* mankind. And the process of change is what we would call “intellectual”: the discovery of the equivalent of universal physical principles, or things that approximate universal physical principles.

And all of these things, that I’ve just described, the series of conditions, all correspond to two things: First of all, they take the form, expressed as universal lawfulness, as infinitesimals, just like the orbit of the Sun: In each infinitesimal instant, what is happening to the infinitesimal is what is determining the orbit in the large. And it’s true in everything else. So mankind, by the power of will, which no animal has—is able to change the universe. And it does it, in terms of the infinitesimal. And it does it, by rejecting the idea of self-evident evidence. You recognize that the evidence of the senses is false, misleading, and that you must find an experimental approach involving *contradictions* in behavior *among* the senses, with respect to some subject matter, to discover a *principle*, and then operate and test that principle in practice, which is the practice of competent modern science. *And this is ex-*

*actly what is forbidden, viciously forbidden, in higher and other education in schools and universities today. This approach is forbidden.*

Now, some people escape and get beyond that prohibition, but in the recent generation, very few did. I saw it. I was there, I experienced it—one of my advantages is, and my disadvantage, is to see what’s happened to the human race, during the course of my adult lifetime. We’ve degenerated. And we’ve degenerated on just this issue that I raised the day before yesterday: the issue of the infinitesimal, as typified by the fact that the Sun’s orbit can not be determined empirically just by looking at the elliptical orbit. You have to discover a paradox in that. And you don’t understand what you’ve discovered, with respect to the Sun’s orbit, until you look at the planetary system. And you come into this question of *harmonics*, as in the sense of Bach, becomes the standard by which you must measure action within the Solar system. And the typical giveaway, is the scientist who says: “This whole idea of harmonics, Bachian har-

monics, as being a reflection of the *physical organization* of the Solar system, of the universe, is bunk. We can’t have that. It’s not scientific. It’s not simply mechanistic, it’s not Cartesian, it’s not Newtonian.” Where, precisely, it is that contradiction between harmonics and vision and the experimental approach to that difference, which defines efficient human knowledge.

And therefore, you see a key to that, a key to every problem we face in society today: We’re operating in a society which says, “What experience teaches us...” Experience has not taught people a goddamn thing! They keep making worse mistakes all the time, and they prefer their mistakes to their successes! Now, that’s a lousy experimental method! If your experiment fails, that’s what you love. If it succeeds, you hate it.

So therefore, what you’re dealing with from the inside, as when you get into what we’re doing, as working at history from the foundations of truth—which are always found in The Basement; they’re not brought into The Basement, they’re discovered in The Basement, by those who go there. And they’re not discovered by those who refuse to go there, or won’t stay there.

So, this thing, which you find our young people were doing, in this series, as we were doing earlier in a certain looser way, with going at the Pythagoreans, and going at the question of the paradoxes posed by Gauss’s attack on the reductionists of the 18th Century: We started from there, to pose the gen-

Johann Sebastian Bach. “The Composer of the universe—not just the Creator, the Composer: the Super-Bach—has ordered a universe such that it does not correspond in its behavior either to deduction from sight or from hearing, but only from looking at the contradiction between the two, and finding a lawful meaning in that contradiction.”



eral nature of science, by referencing the Pythagoreans and their outcome. Then we go into the actual work, of defining modern science from the standpoint of what Classical ancient science, Platonic science, had given us. And there’s a big gap, between 200 B.C., which is the time the Romans began to take over the Mediterranean region, where a degeneration started, a real degeneration, into the beginning of the Renaissance, the 15th Century. So, this period of 17 centuries approximately, in mankind’s history—of European history, in particular—is a period of perpetual degeneration. Oh, some good things were done, but the general course of history was one of degeneration.

### Nicholas of Cusa: Modern European Science

Modern European science, as begun with the Renaissance of the 15th Century, created modern science. It was created on certain foundations which are defined by Nicholas of Cusa, principally. And from the followers of Cusa came modern science, and the kind of questions I’ve just put forward. The *increase in population, the increase in population density, the improvement in the quality of existence, the improvement in the condition of knowledge of mankind, since the Renaissance, as a result of the Renaissance, has been the greatest in all human existence*; the highest rate. And it is *this accomplishment* of mankind, of modern European civilization, which these bastards have tried to destroy. And the place they went at it, was the question of ideas, and the issue of irrationalism of all forms, but empiricism most notably, as I referred to that the day before yesterday: That the empiricist view is the view which is the experimental view of statistics and so forth, as it’s taught in schools today and universities today, and practiced in society, today, is a form of insanity which is destroying the human race. And that was intentionally so.

Because, the issue is this. The issue is the nature of mankind. The difference between man and the beast. The followers of the Delphi Cult of Apollo, and similar kinds of institutions, insisted that there is no lawful difference between man and a beast. Now this was a pragmatic decision in part, made by those who wanted to turn the majority of human beings into mere human cattle, who are not allowed to invent things. For example, the prohibition of man’s knowledge of the use of fire, the Promethean issue, is the characteristic feature of European civilization’s degeneracy, throughout its entire history. Reducing man to the likeness to the animal, denying mankind’s ability to discover universal principles, or to change man’s behavior, fundamentally, through the knowledge of and application of universal physical principles.

Like the opposition to nuclear fission, which came out as a characteristic of the Baby-Boomer generation. The Baby-Boomer generation are the people who came with this anti-nuclear idea. It didn’t come from the question of nuclear weapons, it came from the Baby Boomers. And you look at the Baby Boomers today, there are no scientists among them! Or, only with a few individual exceptions. There’re no scientists. They don’t think scientifically. They *hate* science.

You want to see this? Go back to 1968, and look at the streets of the universities, especially the leading universities, and the streets of society in 1968, in Europe and in the United States. Look at it! What did you see? Absolute mass insanity; *Dionysiac insanity*. They called itself the left, but it was actually the far right—it was the fascists. The Baby-Boomer generation is predominantly a *fascist* generation, which reacted like fascists, against the blue-collar population, against the farmers, against the industrial workers, industrial operatives, against science. They operated on the basis of “feeling,” arbitrariness. They were trained in existentialism, the existentialism of that famous Nazi, Martin Heidegger, or his Jewish friends, Hannah Arendt and so forth. They taught a doctrine which was indoctrinated into the post-war population, the *educated* population, or the educated strata of the population: Those born between 1945 and 1958 in particular.

So if you were born in that interval, and you come from the white-collar-oriented background, you are degenerated: You are a degenerate expression, culturally, of the human species. Because you have now *rejected* the principle upon which human existence depends. You have acted in support of the cult of Dionysius, which is a part of the Delphi cult, which is expressed by the Olympian Zeus of *Prometheus Bound*: anti-Promethean.

So, what you had is division between the white-collar ideology of the university youth, from the white-collar generation, against the blue-collar generation, farmers, and industrial operatives, and scientists and so forth.

So, you had a *viciously fascist, anti-scientific mood*, beginning to emerge and controlling the behavior of the United States. This destroyed the Democratic Party as a force, the division between white-collar and blue-collar destroyed the





USGA



EIRNS/Carlos Wesley

With the generation born between 1945 and 1958: “You had a viciously fascist, anti-scientific mood, beginning to emerge and controlling the behavior of the United States. This destroyed the Democratic Party as a force, the division between white-collar and blue-collar destroyed the Democratic Party!” Left: white-collar office workers, circa 1960; right: a Ford plant in Mahwah, N.J., shut down in 1980.

Democratic Party! And it ceased to be a party of the people, and became an emerging conflict form, in which the so-called upper class, the idiots, the Baby Boomers, dominated the party ranks as a whole.

So, now you have the lower 80% of the U.S. population from that generation, is completely different in its cultural outlook, from that of the upper 20%, especially the upper 3%. The upper 3% and upper 20% of family-income brackets, of that generation, the generation born between 1945 and 1958, is absolutely different, than the parts of the population, born even during the same period.

Now, the way the thing works, it doesn’t work on the basis of each individual as a strict type: It works on the question of group dynamics, in which the characteristics of behavior, that is, when you take an individual aside from the group, they will behave in one way; you put them in the context of the group, the same group on the same question, they will behave differently. When they’re under the influence of the group association, they behave differently than when they behave as individual human beings, where they’re free to think on their own. You see the guy you talk to, outside the classroom, you’re just discussing something, and fine. The minute your reference becomes the university classroom, then you find out, it’s a completely different logic, and he will deny or reject everything he agreed to off campus. This is group dynamics!

And the characteristic of the Baby Boomer is he’s a liar. He’s not a liar because he thinks he’s lying. He thinks he’s being true to his class. He will say, “Well, what is true, after all? One man’s opinion and another man’s opinion. What’s the difference? We all have our opinions, don’t we? We differ in opinions—what do we do? *We get along.* And we accept the instruction given to us by those who have greater power than

we do. We kiss ass.” It’s called dynamics. Group dynamics. Sometimes, it’s called “grope dynamics.”

So, this defines for you the kind of problem we face. That your generation faces; that you and I face: We have a degeneration, an older degeneration—not mine, thank God!—but which was caused to degenerate by coming under the domination of a group within society, which in turn was dominated by this culture, this existentialist culture: which does not believe in a rigorously defined truth, but believes “you have to understand my feelings. You have to understand the feelings of the people I associate with. You have to respond to those feelings. There is no truth. Yes, there is truth, of a certain type—but first of all you have to respond to these feelings!” And you have the “feeling generation”: it’s called the Baby-Boomer generation, they feel everything—especially their neighbors.

So therefore, truth ceases to exist, and in a sense, smell tends to take over.

### **Baby Boomers: No Commitment to Truth**

Now, therefore, you see the conflict. Here you are, you’re in a generation: This whole society’s falling apart. This society is doomed, it’s finished. You see it decaying before your eyes, disintegrating. It’s ruled by a generation which has no commitment to an idea of truth, which is hostile to the idea of science, as you see with the spread of this cult of Global Warming; exhibition of the fact that the whole culture that believes in this stuff, they’re all degenerates! They’re all mental cases, and morals cases, too. They want to kill the human race. “We don’t like this, we don’t like carbon dioxide.” What do you mean you don’t like it? You’re expelling it all the time. And it’s not a very significant factor in the environment, actually, by itself. It’s significant when plants eat it. Plants *love* it. They grab it! “Crunch! Crunch!!”

You want to reduce the carbon dioxide? Increase it. That's how to reduce it. Because, if you increase the carbon dioxide, and you have water and other things around, as well, then the plants will proliferate to get this stuff they like to eat! Because it now comes in richer concentrations, and the plants are ecstatic about that! "Awwrrrw! Rwwrrr!!" And what do they do? They make more plants. And what do they do? They cause a transpiration of moisture in the system, otherwise which doesn't occur. Moisture doesn't just "happen" to the Earth. Moisture is transpired: It's consumed by plant life and it's spit out by plant life. So, it spits out.

So, now you have nicer air, because you add a little more carbon dioxide, and you allowed things to grow. You increased your water transport throughout the system, eliminated deserts and things of that sort, and you made it nicer, and the plants grew! And the world became greener, and greener, and greener! I don't know why these guys call themselves "greenies": They're against green! Call them brownies! Half-baked ones, at that.

Therefore, we as human beings have the intrinsic ability to organize this planet, by understanding how the planet works; how culture works, how the human anatomy works. You want to organize the planet, not just have it in a wild state. We have people in wild states all the time. But by doing that, we actually transform the planet willfully. And by transforming the planet, by growing more trees, by managing the water systems, by managing the atmosphere, and the things that we do, through science and technology, applying these things and producing more things, instead of "blahh"—then we increase the power of mankind to exist, and improve the conditions of life.

Now, that has been destroyed, more or less effectively, by the Baby-Boomer generation's influence. Don't try to dissect the Baby Boomer, you may not like what you find. Take the Baby Boomer as a phenomenon within a social process: The Baby Boomer, as you know the Baby Boomer, is controlled by a social process. It's what others think of them that controls them, especially what they think of powerful influences, which control them. That's what controls them. So therefore, you have group dynamics, which is determined by what the controlling belief is of the group. And the individual in the group, who may have a contrary opinion as an individual, will submit to group behavior, group domination, group control. And that's why you have this behavior of the Baby Boomer. And most of you know it. Most of you are acquainted with



Charma Comer

*"By transforming the planet, by growing more trees, by managing the water systems, by managing the atmosphere, and the things that we do, through science and technology, applying these things and producing more things, we increase the power of mankind to exist, and improve the conditions of life." Here, a sprinkler irrigation system in Idaho.*

Baby Boomers. Matter of fact, you were raised in households where Baby Boomers were allowed to exist. Matter of fact, they ran these households.

And therefore you know, what the problem of the Baby Boomer is, often by knowing your own parents' demoralization. And how you reacted to peer group responses in the neighborhoods in which you grew up, especially in the neighborhoods which were approved of by your parents. So group behavior controls you, and you were trying to find your meaning in life, within the special domain of this group behavior.

Now, some of you represent those who realize there's something wrong with this whole racket. And that what your parents believed was insane. You don't say it that way, sometimes you do, especially when you're angry at them: "Mother! You're insane!" "Mother, you're crazy!" "Mother, you should marry a toad, you deserve it." You know, things like—kindly. Kindly family reactions of daughter to mother!

So, you know it. But you also know something else, those of you assembled here in particular: You know that *this is insane*. You know the world has to change, to get away from this. Therefore, your concern, if you're not going to go insane, is to define what the change must be. And you begin to find satisfaction, as I've seen you do this, when you get into the idea of discovering something outside Baby-Boomer ideology. Which is called "truth." It's otherwise known as "scientific principle." It's otherwise known as the same issue, the existential issue, which I posed in summary form, on Thursday, in the presentation there.

## The Essential Existential Question

Because we've come to a time in the history of the world, the history of the United States in particular, that the existential question, the essential existential question, is the immediate question before humanity: This society, in its present form—though people say, "I gotta save for my future; I gotta save for my retirement." "You're not going to make it, buddy! *Don't worry about it! Spend now!* Retirement will never come. You won't get that far—not the way things are going now!"

They say, "No, no, no! We're saving for our retirement."

Hah! Retirement from what? To what?

So therefore, you have a sense that there is no future, in the society the way it's operating. And all the evidence of experience proves that. For example: In Western and Central Europe, there's not a single nation that has a government. There are things they call "governments." For example, take the case of Germany: Germany is probably the most approximately governed nation of Western and Central Europe. For example, it's opposition in Germany, today, over the objection of the rest of Europe, its objection to this system of globalization, with hedge funds, for example. The only nation in Western and Central Europe which is resisting the hedge funds systematically, as a matter of law, of the national will of the government, is Germany. No other government is actually seriously resisting it: that's a matter of fact, right now. Every other government is not.

Most governments of that type are going along with a potential war with Russia, and other nations—China and India; especially Russia and China. They're going in that direction. Most of Western Europe—there's not a competent government in any of them. You see, in the case of Germany, you take the contrast between what Germany's position was under the recent Schröder government, and what it has become under the successor to the Schröder government—a government which has gone from potential to impotence; a government which has gone from an orientation toward bringing European nations together in cooperation around things like power, distribution of power, and generation of power, into the directly opposite things. You have a government, which, although the Green Party is disintegrating, it's disintegrating because the principle of the Green Party has taken over most of Europe, in the form of the global warming hoax, and similar kinds of things. So you don't need Greens any more. You don't need degenerates, when the whole population is becoming degenerate, when the whole system is becoming degenerate.

You see in the United States, you see the *absolute impotence* of the Democratic Party! The Democratic Party had a victory in the midterm election, a victory which *we* played a crucial part in making possible. And I personally was involved in doing that, by our defense of Social Security: I stimulated the organization of the defense of Social Security—I, personally. And the leadership of the Democratic Party accepted my leadership, on that issue. And mobilized. They defended the

Social Security system, and vigorously, in 2005, during which time I was treated as a hero. Even though it was reluctantly, but nonetheless, I was treated as a hero. But then, at the same time, when I warned that we're going to lose the auto industry, and we're going to lose our national independence, they did *absolutely nothing!* to defend this capability—this capability, which is lodged within the auto industry, not just the auto industry itself.

They did *less* than nothing! They accepted the hedge fund raid against the nation. They accepted the continuation of this illegal, immoral war in Southwest Asia, and its spread. They allowed an inhuman ape, Cheney, to dominate the United States, to dominate its politics. The Democratic Party, which once it got into power, proceeded to *betray everyone who voted for it!* under the present leadership.

What're you looking at? You're looking at a Baby-Boomer phenomenon, in Europe, and the United States, and elsewhere: the Baby-Boomer ideology.

What is the Baby-Boomer ideology associated with? It's associated with the group in society, which is the upper 3% of family-income brackets. These are the multi-billionaires: the guy who flunks the management, and gets out with a golden parachute with a billion dollars or something, that's paid for at the expense of the rest of humanity. You find a decreasing level of income of the population; you find a decreasing level of productivity in every region of the United States, of physical productivity; a decadence which is impossible. We find that more money is being printed than anyone can count, which means that the whole system is bankrupt: The entire world system, including the United States itself, is hopelessly bankrupt. And somebody's saying, "What about my money?" Hah! Your money! Toilet paper is more useful than your money. And we know how to use it. Save the cost of toilet paper. (Except it's electronic in form, and that's a very unpleasant thing to use.)

## Sight and Hearing: The Paradoxical Conjunction

So, it comes back to this existential question, which I posed on Thursday: The existential question is, what is the nature of mankind? What is human nature? What is the function of the human being, the principal character of the function of the human being in the universe?

Well, that's what we're doing in *The Basement*: is applying the exploration of the discovery of physical principles, on which the universe's management depends by human beings. And conjoining that together with music, in the sense of the Bach choral tradition. And combining the two together, to bring the senses of sight, and senses of hearing, into conjunction, into paradoxical conjunction. And it's as the person going through the music work, who's coming from the scientific work into the music work in the same period, coming and finding out that you can not sing effectively, in the way you would think, if you governed a musical performance by visual



EIRNS/Brian McAndrews

*Combining the discovery of universal physical principles—real science—and music, in the sense of the Bach choral tradition, “to bring the senses of sight, and senses of hearing, into conjunction, into paradoxical conjunction.” In this photo, the men’s section of the LYM chorus performs a Bach motet.*

standards, mathematic standards. Doesn’t function. And it is by seeing this contradiction, and experiencing this contradiction, that you are aided, in getting free of sense-certainty, the notion that what you see and what you hear, and above all what you smell, is the reality of your existence; and in seeing that there’s something else outside this apparent reality, which is distinctively human: the human ability to rise above the limit of the senses, to recognize in the *contradictions* among the senses, and through experience, to recognize that the human mind has an engagement with the real running of the universe.

And thus, you get a human being, who is characteristically immortal. Because the part of the human being that dies, which must die, is the biological part of the human being. It passes on. But the impact and the role of the human being does not vanish with the death of that individual. The individual is the purveyor and conveyor and generator of discoveries of universal physical principles, and of *ideas related to those discoveries*, which shape and reshape society, so the society is organized in a new way, as a result of the role of such individuals in society; and such individuals in society, who reorganize society! To get it to abandon its insanities, to come, not to sense-certainty, but to a certainty about the nature of the universe, and a certainty about the role of man in the universe, a sense of the Noösphere: Such individuals are immortal, because the discoveries they contribute, whether fundamental discoveries or related things, become *embedded in the culture*, as the contribution of individuals. Try to trace out any contribution in art, or science, and so forth—try to trace it out, and you find always, the

*individual’s role is unavoidable, can not be excluded!*

And thus, the individual is immortal in that respect. Because they may die, but what dies is the animal within the person. The person, if they are valuable, if they are contributing, lives on. We know this in the sense of great scientists and others, great artists and others, whose influence radiates across generations! We know this most immediately in terms of three or four generations of experience, because we live in the middle of experiencing simultaneously, representatives of four successive generations. That’s the nature of our society. We can recognize the differences that occurred in the development of the society over the span of these successive generations.

We can go from that, to looking at history more broadly. We can look at various branches of human culture, across the waters, across borders. We can look back further, into earlier generations, centuries

before. We can trace the development of these ideas on which society develops, which exist within us as part of our accessible experience. And we see that it is the selection of that which is precious, in that process of development, which must go forward and must live. And it’s in *that* part of our life, in our determination to express *that*—into a future which exists beyond our death: *That*, is the meaning of human life.

And what I raised Thursday, by using the example of the orbit of the discovery of gravitation by Kepler, as an example of the role of the infinitesimal: It is this conception of the infinitesimal, as applied more broadly, and the notion of principles of organization of society, as based on understanding of these infinitesimals, that is where the hopeful future of mankind lies.

And the problem that you have, in your generation: You are young adults, where an older adult generation has failed, existentially. There may be individuals in the older generation who have not failed, but the generation as a whole, especially the white-collar generation has failed. They’ve failed catastrophically.

Your job, because you are receptive to these ideas of principle, to the notion of the individual as immortal, an immortal personality, despite the death of the mortal body, is *your* destiny, and your responsibility to guide the changes which must occur in society, if society itself is to survive. And therefore, your generation has a unique historical role, in the existence of mankind as a whole.

And to understand this in yourself, and to see your identity as so situated, is my mission for you.

Thank you.

# Welcome Adventurer!

*The LYM “Basement Team”—a small group of researchers operating from the basement of a farm in Northern Virginia—presents a preliminary report.*

You have now arrived at the threshold of the third stage of an ongoing investigation, commissioned by economist and statesman Lyndon LaRouche, and conducted by teams from the LaRouche Youth Movement (LYM), into the most crucial breakthroughs made in scientific method. If you have not already reviewed and/or worked through the first two phases of the project, namely, an interactive pedagogy covering Johannes Kepler’s investigation of the principle which governs the motion of heavenly bodies in his *Astronomia Nova* (*New Astronomy*), and secondly, a similar exposition of Kepler’s other main work developing the universal quality of this principle in his *Harmonices Mundi* (*The Harmony of the World*), it is necessary that you do so, in order to situate the contents of the following report. ([www.wlym.com/~animations](http://www.wlym.com/~animations))

In a time-period reminiscent of the extended moment of ambiguity felt when watching a coin spinning across a surface and wondering how it will fall, the significance and sheer ne-

cessity of this scientific and epistemological undertaking is hopefully not lost upon the reader: U.S. “defense” systems are at this moment pointed at Russia and China, the President of Vice continues to rabidly press for war in Iran, and the present world financial architecture creaks and groans underneath a monstrous weight of speculation. On the other hand, conferences are being held around the world on the subject of national and international breakthrough infrastructure project proposals, such as the April 24 Moscow conference to deliberate over the Bering Strait tunnel project. Thus, we are not left to merely wonder, “heads, or tails?”, but rather, are beings of free will, capable of ourselves determining the tide of times.

That is the intention of the third team embarking upon the third phase of the LYM’s investigation: a leap from the discoveries of Johannes Kepler, across a chasm of nearly two centuries, to Carl F. Gauss’s determination of the orbit of Ceres, the first asteroid ever sighted by man. The challenge posed to this team, is to recreate the method applied by Gauss

in order to achieve this feat, which contrasted with the utterly erroneous attempts of the narrow-minded empirical thinking of his contemporary mathematicians and astronomers, and which leads to the foundations of all competent modern scientific method, including economic forecasting. The first dilemma encountered was Gauss’s own explicit obfuscation of his method. Thus, over the course of our recent-months’ investigations, we have set about our mission on several fronts: building up a grounding in the aforementioned works of Kepler, as well as his predecessor, Nicholas of Cusa; digging up the history and battle of ideas developed in the intervening period of Kepler to Gauss, especially one of the key minds of the 18th Century and teacher of Gauss, Abraham Gotthelf Kästner. The fruits of our labor thus far are here presented to the reader with the intention of pro-



EIRNS/Tarrajna Dorsey

*The LaRouche Youth Movement’s “Basement Team” in action: Sky Shields (left) and Michael Kirsch at work on the Gauss project. The article presented here is the first in a series of interim research reports.*

viding an interim report of our work, which will hopefully serve to whet the appetites of some, and stave off the hungry appetites of others, until we produce the final report.

Let it be said, in conclusion, that the significance of this work for the immediate and extended future of mankind is evidenced by the current state of our national economy, as reflected by our space program. From man's first strides on the Moon in 1969, a great leap backwards has been made in not only the physical capability of our space program, but also in the scientific-cognitive capability to put it to good use. Indicative of this is the fact that on July 7, the *Dawn Mission*, a

NASA/JPL project, will be launched, heading for Vesta, and then Ceres—the two largest asteroids found in the asteroid belt. Soon, a vast amount of information will be available concerning their water and mineral content, and the nature of the formation of the asteroids in general. However, without the method of discovery and knowledge of principle yielded by the investigations of the LYM into the roots of scientific method, all of the data, photographs, and statistics in the world will not produce the discoveries which are required for the furtherance of our current civilization, or of mankind as a whole.

Happy Adventuring!

---

## How the Venetians Tried To Erase Kepler From Science

---

# Empiricism as Anti-Creativity

by Peter Martinson

Carl Friedrich Gauss's explosion onto the stage of history in 1801 shocked the world. His emergence causes one to ask the old question, *where do geniuses come from?* Can genius be taught, or must they be born that way? Since the mission of the LaRouche Youth Movement is to create a society which will produce an increasing density of geniuses, these are important questions. Part of the challenge with Gauss, though, is that he wouldn't release a scientific work unless it was scrubbed free of evidence of how he made the breakthrough. But, we have two keys with which to unlock the mind of Gauss: Abraham Kästner (1719-1800) and Johannes Kepler (1571-1630).

What follows is a look at the scientific environment at the time Gauss made his famous determination of the orbit of the asteroid Ceres. Of course, that means we'll have to take an excursion into the murky underworld of the British Royal Society, and how they created their golem, Sir Isaac Newton. We will also have to look at what happened to the works of Kepler, and how Europe responded to his launching of modern experimental astrophysics. Europeans during Gauss's time were living in a world dominated by the British East India Company. While this empire tried to exert its dominance over Europe, especially after 1763, the American conspiracy to create a republic had cast its challenge, with a revolution inspired by the great statesman and scientist Gottfried Wilhelm Leibniz (1646-1716). The optimism unleashed by this worldwide, was crushed in Europe when the French Revolution, run by the British top-down, turned into a nightmare.<sup>1</sup>

People don't know much about the 18th Century, because the true history has been obscured by the misnamed "Enlightenment." This Enlightenment was not the product of the so-called "scientific revolution" from Copernicus to Newton,<sup>2</sup> but a response *against* a true revolution launched by Nicholas of Cusa (1401-64),<sup>3</sup> and his followers Kepler and Leibniz. Attempting to replace true scientific advance by the occult beliefs of the Newtonians, is hardly enlightening. Moreover, it doesn't last, unless the target population is either brainwashed, or beaten down under police-state conditions. The non-science qualities of Newtonianism, along with other empirical cult beliefs, are regularly challenged by phenomena from above.

### Gauss and Kästner

As soon as the 18-year-old hotshot Carl Gauss arrived at Göttingen University in 1795, he headed to the library and used his new library privileges. Among the books checked out, were the *Transactions of the Imperial Academy of Sci-*

---

2. Alexandre Koyré was a student of Husserl and Hilbert at Göttingen, and later worked with Alexandre Kojève in Paris, lecturing on Hegel. His theory of the astronomical revolution established between Copernicus and Newton was a predecessor of Thomas Kuhn's *Structure of Scientific Revolutions*, which argues that science goes through phases separated by paradigm shifts. These guys were crooks, squatting outside the universe, trying to push the existential idea that the willful, passionate act of discovery by man really doesn't exist—that it is just an effect of the passing of history. To disprove this, just relive the discoveries of Kepler and Gauss!

3. See Michael Kirsch "A Scientific Problem: Reclaiming the Soul of Gauss," in the June 2007 issue of *Dynamis*, Vol. 1, No. 4. <http://www.wlym.com/%7eseattle/dynamis>.

---

1. See Tarrajna Dorsey, "The Orbit of Gauss," [http://www.wlym.com/~animations/ceres/interim\\_tarrajna.html](http://www.wlym.com/~animations/ceres/interim_tarrajna.html).

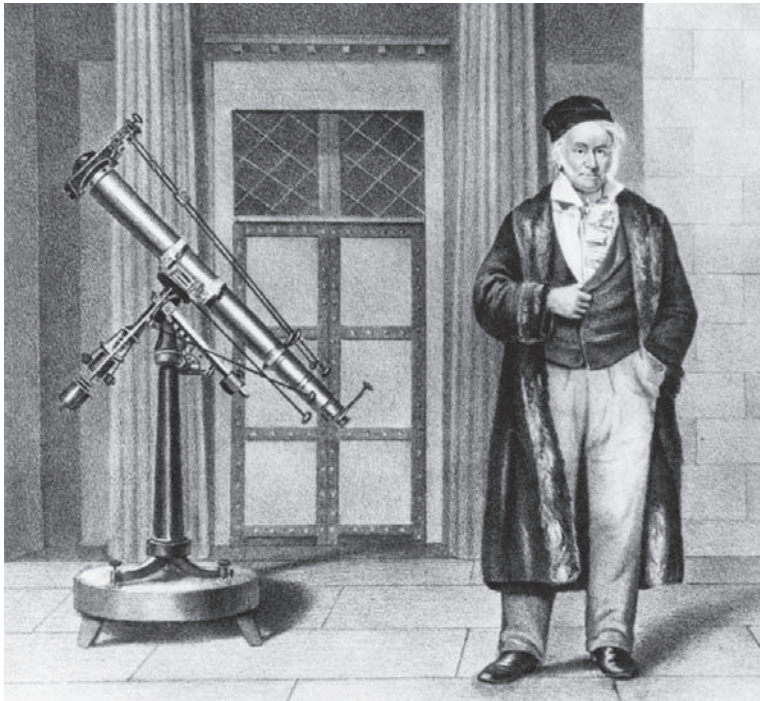

AIP Niels Bohr Library

Carl F. Gauss kept secret the methods by which he made his discoveries, in an age in which creative geniuses like himself were under attack by the Venetians and empiricists of the self-proclaimed Enlightenment. But there do exist keys to unlock the mind of Gauss.

ences in St. Petersburg. As he told his former teacher, Eberhard August Wilhelm von Zimmermann (1743-1815), it made him somewhat unhappy to read these papers, since he found that almost all of his personal discoveries in mathematics had already been made by others. But, “What consoles me is this. All of Euler’s discoveries that I have so far found, I have made also, and still more so. I have found a more general, and, I think, more natural viewpoint.”<sup>4</sup> Leonhard Euler (1707-83), then chairman of the Mathematics Department at the St. Petersburg Academy, was the world champion of Newtonian mechanics and mathematics.

One of Gauss’s teachers, Abraham Gotthelf Kästner, was at this time nearing the end of his life, and was preparing to produce the first-ever complete history of mathematics. This was not intended as an academic exercise, but as a sharp political intervention. Kästner was a sworn enemy not just of Euler, but of the entire imperial apparatus that had been used to uproot the legacy of Leibniz and J.S. Bach, and rewrite European history from the standpoint of Newtonianism. In this capacity, he launched the German Renaissance with Gotthold Lessing and Moses Mendelssohn, and led Göttingen University to become the scientific counterpole to the Newtonian

nest that had taken over Leibniz’s Berlin Academy. He was also the leader of the pro-American conspiracy in Germany, and had hosted the visit by Benjamin Franklin to Göttingen.<sup>5</sup> Kästner’s mission was to prepare the German people for an American-style revolution, instead of the British counter-gang operation known as the “French Revolution.”

Soon, Gauss had the opportunity to tell Kästner that he had proven the constructibility of the regular heptadecagon (17-sided polygon), which he would hold until the end of his life to be his most important discovery. At first, Kästner was unimpressed, much distracted by his other projects. But then, after Gauss showed him how the construction worked, Kästner became suddenly shocked, peered at Gauss, and told him that he himself had already discussed the issue in his *Anfangsgründe*.<sup>6</sup> But, he said, if Gauss could develop the theory of the general case, he should write an essay and submit it to him.

The first summary of the general theory of the equal divisions of the circle was presented by Johannes Kepler, in the first book of his *Harmonices Mundi*, where the excited reader can follow his constructions of all possible regular figures. Here, Kepler proved that the only constructible figures are the triangle, square, pentagon, hexagon, pentakaedecagon, and all of their doubles (including all polygons derived by doubling the number of sides of constructible polygons), because everything else has sides whose lengths are unknowable by a human mind. This included the 17-sided figure, which Gauss had just shown to be constructible! Gauss had just proven Kepler wrong, and had expanded the realm of knowability into what Gauss would later call the Complex Domain. Kepler would have been excited, and Gauss’s general development of the theory formed the basis of his *Disquisitiones Arithmeticae*. Gauss had discovered that the underpinnings of everything he had yet discovered in numbers and algebra, lie in the domain of geometry, as had been known and demonstrated previously by Kepler and Leibniz. Gauss issued his discovery publicly in his 1799 doctoral dissertation, as an attack on Euler, Lagrange, d’Alembert, and the rest of the Newtonian priesthood of the time.

Kästner had brought Gauss into the conspiracy. During his time at Göttingen, Gauss would discover the hidden legacy of true European science. As Gauss would find out, science had become so polluted through the promotion of Newtonianism and related reductionist confinements, that many of the top scientists were either aiding the promotion, or felt obli-

4. “Letter from Gauss to Zimmermann” October, 19 1795, found in the *Gauss Werke*, Vol. 10, Part 2 in Ludwig Schlesinger, *Über Gauss’ Arbeiten zur Funktionentheorie*, p. 19.

5. This visit was reported in the Sept. 13, 1766 issue of the *Göttingen Gelehrte Anzeigen*, p. 873.

6. Abraham Gotthelf Kästner, *Anfangsgründe der Mathematik (Elements of Mathematics)* (Göttingen 1758-69, 4 volumes; 6. Aufl. 1800). This was the standard mathematics textbook at Göttingen University.

gated to bow to the pressure of the scientific priesthood. True scientific progress was being suppressed. Only a small group of revolutionaries was fighting to keep alive the spirit of scientific discovery in the tradition of Johannes Kepler and Gottfried Wilhelm Leibniz.

### What Was Kästner's Beef?

Elsewhere in Kästner's *Anfangsgründe*, he launches a direct attack on Newtonian mechanics. In section 237, he says, "Kepler found from the observations, that the planets go in ellipses around the Sun, which lies at the focus of these ellipses. Regarding this, Newton showed that this would happen if the planet were driven or pulled around the Sun by a force which varied inversely as the square of the distance. I consider his proof of this to be inadequate." He proceeds to derive Newton's "inverse square law" from the principle of elliptical motion. He then says that Newton had assumed a conic section, and derived his law from that (as Kästner had just done), but he had not shown that an inverse square "force" would produce conic section motion.<sup>7</sup>

Kästner goes on: "This criticism was justly made by Johann Bernoulli, who gave the first general solution to the problem ... [this] latter was not accomplished until Bernoulli, by means of his discoveries, had considerably expanded the integral calculus.... [John] Keill translated this discovery into the expressions of the fluxion calculus, and, here also, Newton was not defended more successfully against Bernoulli's criticisms than before" (emphasis added).

To the layman, this might seem like just some academic disagreement. Hey, we all have disagreements, right? Wrong. In the late 18th Century, these were politically explosive words, because Isaac Newton (1642-1727) was held by the dominant world empire as the high priest of science. It was generally known, that Newton had claimed that he could derive all of the discoveries of Kepler with his principle of gravitational attraction. Newton claimed further, that the primary cause of all motion in the universe, was this force of attraction between two bodies along the straight line between them. Newton's first book, *Philosophiæ Naturalis Principia Mathematica*, began by proving that this law of attraction, combined with his "Axioms of Motion," caused planets to move in conic sections around the Sun.

When Newton was asked how he had discovered such a remarkable law, that things fall towards the Earth, he gave the story that an apple fell and hit him on the head while he was staying at home with his mum in Woolsthorpe in 1666. He might have been joking, but he could never explain how he made not only this discovery, but any of his discoveries. Many theories have been developed, even that the discovery came out of Newton's occult beliefs. But, Newton would never speak publicly about it. It was as if Newton did not know how

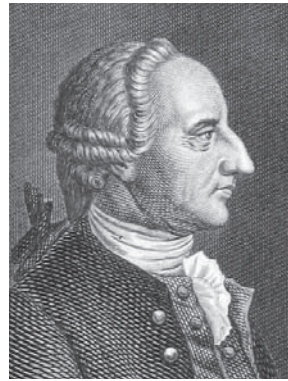

Abraham Kästner, Gauss's teacher, was an outspoken proponent of Kepler, who had the courage to attack Newton.

he'd made them. Perhaps it was he, himself, that had been dropped on his head.

Likely unknown to Newton at the time, England was in the process of becoming the new home of the Venetian oligarchy. The Dutch King William of Orange invaded in 1689, and installed himself and his wife, Mary, as joint monarchs. Holland had been the cockpit of Venetian finance up to this time. This "Glorious Revolution," as it was called, resulted in the immediate creation of the Bank of England

and the launching of a huge financial swindle called the South Sea Bubble.<sup>8</sup> But, the reborn empire had to stupefy the population, in order to make this work; therefore a key part of the Glorious Revolution, was the pumping up of the Royal Society's Isaac Newton, as the champion of science.<sup>9</sup>

One of Newton's handlers, was a notorious plagiarist named Edmund Halley (1656-1742), who believed the Earth was hollow. Halley had already gotten in a huge dispute with the Royal Astronomer, John Flamsteed (1646-1719), over the trajectory of a comet. Flamsteed demonstrated that the comet of 1682 was the same that had appeared in 1680, having travelled in an orbit around the Sun. Halley and his cronies didn't believe him, but when Flamsteed intimated that it was the same comet that had been observed by Kepler in 1607, Halley publicly claimed the hypothesis for his own, and predicted a return of the comet in 1757.

Two years later, according to an account by Abraham de Moivre (1667-1754), Halley met one night in 1684 at a London bar with two of his Royal Society cohorts, Robert Hooke (1635-1703) and the president of the Royal Society, Christopher Wren (1632-1723), and told them he was searching for someone who could prove that a planetary elliptical orbit was created by an inverse square force. Both said they could, but neither would produce the proof. Later that year, Halley reportedly asked Newton if he could produce a proof. Newton said he could, and Halley pushed him to publish a book on it, to be promoted widely. Newton was reluctant to publish this, as his "discovery" had been made while in the heat of alchemy experiments.<sup>10</sup>

8. Newton actually made a bunch of money in this financial swindle.

9. The British Royal Society was originally set up by a network of freemasonic groups, such as the Scottish Rite, to study alchemy and the occult. Jonathan Swift picks the society apart in his *Gulliver's Travels*.

10. John Maynard Keynes, who became notorious for his addiction to Newton memorabilia, declared Newton "the last of the Babylonians" after purchasing the chest of Newton's undergraduate notes from his time at Trinity College. Expecting to find the roots of development of Newton's theories of

7. From Kästner's *Anfangsgründe*, section 237.



The “law” of attraction had excited many academics in England, including David Gregory (1659-1708), who wrote a textbook on astronomy, completely couched in terms of Newton’s inverse square law and his fluxion “calculus.” Gregory’s uncle, James (1638-75), who ceded the University of Edinburgh’s Chair of Mathematics to his nephew upon his death, had been in correspondence with Newton, and had done much of the number series work that later appeared in Newton’s fluxion “calculus.” The younger Gregory, after inheriting his uncle’s Newton material, read Newton’s *Principia* in 1687, and moved down to Oxford to become the Savillian chair of Astronomy. He brought his student John Keill (1671-1720) with him, who became so enthralled, that he wrote his own “Newtonian” astronomy textbook.

Isaac Newton did not discover the calculus. Newton actually wrote very little on the calculus. Leibniz wrote several letters to him, each more skeptical than the last, asking for more than just a mathematical derivation of Newton’s formulas, but only got two unsatisfactory replies.<sup>11</sup> The first public references to his “fluxions” were in a book by John Wallis (1616-1703), who printed the two letters Newton had sent to Leibniz, as an appendix to his own algebra textbook. Additionally, there is no evidence of any work done leading up to any discovery by Newton, previous to 1684, besides his extensive writings on alchemy and black magic. Either Newton did not know how he “made his discovery,” or he didn’t want to reveal the true story—that he was a raving priest of the occult!

Newton retired from science after his friends pushed him to a nervous breakdown in 1693. As an attempt to put him back to work, Lord Halifax and Chancellor of the Exchequer Charles Montagu gave him a new job as Warden of the Mint in 1698. Montagu would later become the president of the Royal Society, the Prime Minister, and then the British ambassador to Venice. Interestingly, Halley and Gregory both also became Wardens of the Mint for both Chester and Scotland, respectively, in the Glorious Revolution’s project to cut the circulating currency in half. During this period, the great high priest of science Newton would tell his admirers that he no longer wanted to be bothered by pesky stuff like mathematics, because it always made his head hurt. He then wrote a book calculating

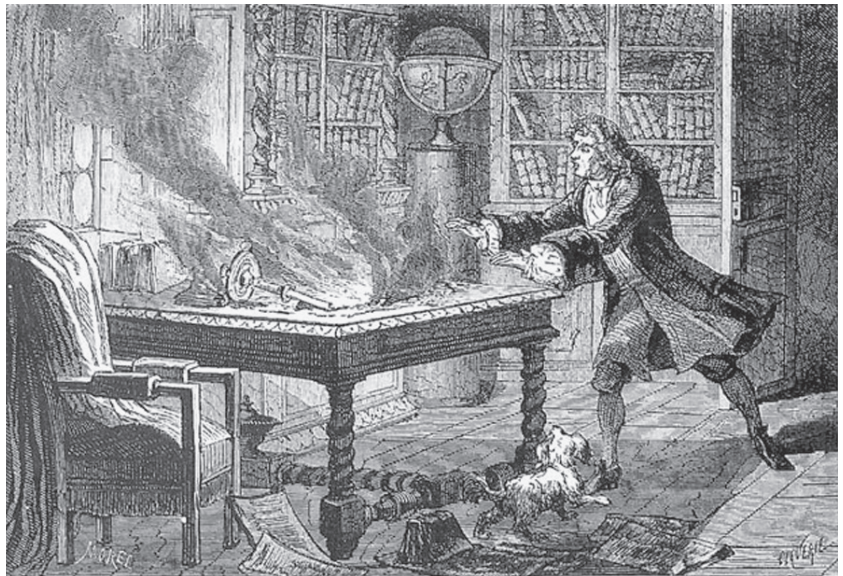

Isaac Newton’s dog burns his alchemy writings in 1693.

the precise date of the Armageddon based on the prophecies in the Book of Daniel and the Revelation of John.

In 1708, John Keill submitted a paper to the British Royal Society, publicly accusing Leibniz of plagiarizing Newton’s calculus. When Leibniz saw this attack, he wrote to the Royal Society demanding a formal apology, but Keill just upped the attack. At this point, Leibniz most likely recognized that this was an institutional attack, coming from the Venetian entity that had taken over the English government. Newton might not have understood the operation, as he was quite busy in his new “Alan Greenspan” role as chief magician, but he was pushed into the conflict by Keill, Montagu, Locke, and the others. They told him that his calculus was being paraded in Europe under Leibniz’s name, and that Leibniz was saying that Newton was guilty of plagiarism. Since Newton couldn’t tell one way or the other, the Royal Society set up a committee, with Newton at its head, to investigate the matter. They put out their report in 1715, called the *Commercium epistolicum*,<sup>12</sup> which appears to have been written in the hand of Newton himself. Written like a little kid’s tantrum, it claims that the efforts of Leibniz to reveal Newton’s method of discovery, were actually done so that Leibniz could write a calculus under his own name. It was published anonymously, since everybody on the committee, including Halley and de Moivre, thought it was such an obvious hoax.<sup>13</sup>

Abbé Antonio Schinella Conti, another one of the “New-

gravitation and the calculus, what Keynes found instead were thousands of pages of writings on alchemy, Armageddon, and various kinds of black magic. In fact, Keynes was so good as to point out that Newton was not unique in his study of the occult, as the most frequently checked out genre of books at his *alma mater*, Trinity College, were on alchemy.

11. David Eugene Smith, *A Sourcebook in Mathematics* (New York: Dover, 1959), pp. 224-228.

12. Isaac Newton, “An Account of the Book Entitled *Commercium Epistolicum Collinii et Aliorum, de Anlysi Promota*,” *Philosophical Transaction of the Royal Society of London*, No. 342 (1714-15), pp. 173-224.

13. Hundreds of pages of drafts for follow-up reports were found among Newton’s papers, each one with different formulations of personal slanders of Leibniz.

ton handlers,” appeared at around this time. He had contacted Leibniz in 1715, claiming to be one of Leibniz’s followers, and offered to ferry letters between him and Newton, personally, to smooth the waters between them. Conti’s more immediate project, though, was to help Newton’s doctor, Samuel Clarke, brainwash Caroline of Ansbach, Leibniz’s former student and wife of the future King George II, to believe in Newton. Leibniz’s letters back and forth with her form the body of the *Leibniz-Clarke Correspondence*, and begin with Leibniz illustrating the effects of the Venetian psy-war on the English academics. At one point, Caroline complained to Leibniz that Conti had “lost” key sections of Leibniz’s letters.<sup>14</sup>

After Leibniz died, Conti would lead the charge to set up “Newton salons” all around Europe, in cahoots with Voltaire and other agents, in order to attempt an erasure of Leibniz’s legacy. This operation was at issue when Kästner issued his counterattack, which demolished the main accomplishment of Newton’s *Principia*. Kästner’s counterattack was just one of many that made up the standard mathematics textbook at Göttingen University.

## Johannes Kepler

This Newton operation was not a scientific issue, but a continuation of a Venetian policy launched at the end of the 16th Century to finally crush the nation-state, and to return the population to a mental condition of herded cattle. Some in Venice were unhappy that the scientific legacy of the 15th-Century Renaissance had not been eliminated by the horrors of religious warfare intentionally unleashed by the Spanish Inquisition. Science was still moving forward, as exemplified by the work of John Napier (1550-1617), William Gilbert (1544-1603), and especially Kepler. So, a new policy—empiricism—was designed by the Venetian teacher of Galileo Galilei (1564-1642), and also the organizer of the Thirty Years’ War, Paolo Sarpi (1552-1623). In Lyndon LaRouche’s words:

[T]he military-strategic and related changes in the order of modern military and related affairs persuaded Sarpi’s new party of Venice to loosen the barriers to acceptance of some degree of scientific-technological progress. Sarpi house-lackey Galileo’s awkward pla-



*Johannes Kepler has been the target of nearly 400 years of efforts by the Venetians and their successors to steal, distort, or obliterate his phenomenal discoveries.*

giarizing of the work of Kepler, on the issue of the motion of the planets about the Sun, was typical of the new spirit of empiricism unleashed by Sarpi’s revival of the precedents of the medieval William of Ockham. In effect, in Sarpi’s bedroom, the Olympian Zeus unbuttoned himself.<sup>15</sup>

Kepler had sent copies of his work to Galileo at the University of Padua, and had asked him to publicly support the Copernican view. Galileo not only did not do this, but failed to mention Kepler even once in his 1632 *Dialogue on the Two Sciences*, a “non-biased” comparison of Ptolemy’s and Copernicus’s models of the Solar System, which was printed two decades after Kepler communicated his discoveries to Galileo. Perhaps Galileo was too frightened by his persecution by the Inquisition to respond to Kepler adequately,<sup>16</sup> but many of the “discoveries” reported in his later works are to be found in the books Kepler had sent to him. Galileo’s job, as given to him by Sarpi, was to come up with axioms of physics, from which Kepler’s results could appear to follow, as if deductively.

A later follower of this policy, the Dutch-trained René Descartes (1596-1650), designed more axioms of physics.<sup>17</sup> He was infamous for his battles against Pierre de Fermat (1601-65) over the speed of light in a medium. Descartes said that light speeds up when passing into water; Fermat said it slowed down; and Descartes then attacked him. As part of his work, Descartes formulated what is today called “analytic geometry,” which attempted to represent various curves as the products of algebraic formulas. He claimed that all phenomena of physics were created by mathematical equations, and could thus be investigated by those equations. He plagiarized Fermat’s method of graphic representation, poorly, to look at the effects of the equations. He ran into a problem, though, with a class of curves he called “mechanical curves,” such as the cycloids, logarithmic curves, and logarithmic spirals. These curves all represented relationships between incommensurable magnitudes, such as the relationship between the

15. Lyndon H. LaRouche, Jr., “The Principle of ‘Power,’” *EIR*, Dec. 23, 2005, p. 41.

16. Many historians give this explanation, such as Arthur Koestler in his book *The Sleepwalkers: A History of Man’s Changing Vision of the Universe* (Harmondsworth: Penguin, 1964). Koestler offers a much referenced slander of Kepler as a “mystic” in a chapter from this book titled “Watershed.” In fact, Koestler was himself a mystic. He willed money to the University of Edinburgh to set up the Koestler Parapsychology Unit. The university offers PhDs in the study of paranormal activity. Check out their webpage: <http://moebius.psy.ed.ac.uk/Koestler>.

17. Leibniz wrote a scathing refutation of all of Descartes’ laws of motion, in his “Critical Thoughts on the General Part of the Principles of Descartes,” (1692) as found in *Gottfried Wilhelm Leibniz: Philosophical Papers and Letters*, Leroy Loemker, ed., pp. 383-412. For example, he shows that, contrary to what Descartes says, when a smaller ball impacts a larger, stationary ball, the smaller one does not rebound with equal and opposite speed, while the larger one stays put.

14. H.G. Alexander, ed., *The Leibniz-Clarke Correspondence* (New York: Manchester University Press: 1956).

circle and its diameter, as studied by Nicholas of Cusa. Since these curves couldn't be represented by algebra, Descartes banned them from the universe.

But, this was just the type of problem Kepler had left for the future, after his death. Among Kepler's breakthroughs in his *Astronomia Nova*, was the demonstration that the *equant* doesn't exist. There is no fixed point in the universe.<sup>18</sup> On the other hand, there are principles of the universe. One effect of these principles, as discovered by Kepler, was that a planet will speed up and slow down, such that the area swept out by a line connecting it with the Sun is proportional to the time in which it is swept out. As overjoyed as Kepler was when he discovered this, he also showed how the area cannot be found directly.

[Given] the mean anomaly, there is no geometrical method of proceeding to the equated, that is, to the eccentric anomaly. For the mean anomaly is composed of two areas, a sector and a triangle. And while the former is numbered by the arc of the eccentric, the latter is numbered by the sine of that area multiplied by the

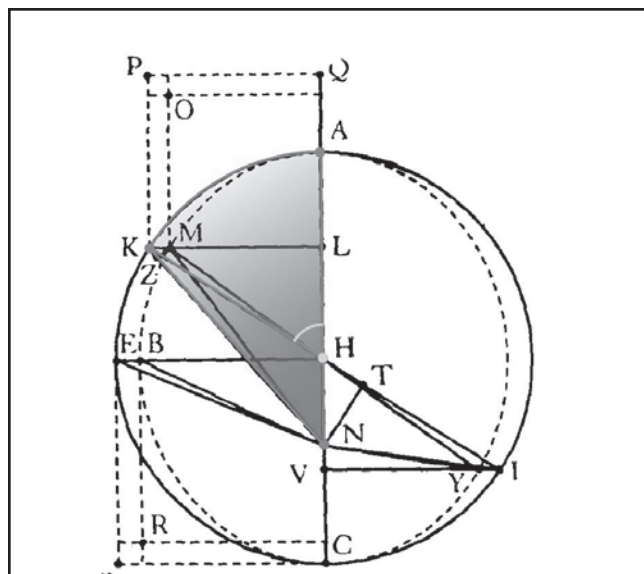

Kepler calls the area KNA the *Mean Anomaly*. The area of the circular section (KHA) is just equal to the angle KHA, called the *Eccentric Anomaly*. The area of the triangle (KHN), is one half the product of its base, HN, times its height, KL, which is the Sine of arc KHA.

We can write this simply as follows

$$E + 1/2 e \sin E = M$$

where *E* is the *Eccentric Anomaly*, *M* is the *Mean Anomaly*, and *e* is the eccentricity HN.

18. Leibniz would later reformulate this principle, in his correspondence with Samuel Clarke, by showing that absolute space is a fantasy.

value of the maximum triangle, omitting the last digits. *And the ratios between the arcs and their sines are infinite in number.* So, when we begin with the sum of the two, we cannot say how great the arc is, and how great its sine, corresponding to this sum, unless we were previously to investigate the area resulting from a given arc; that is, unless you were to have constructed tables and to have worked from them subsequently [emphasis added].

All that could be found was an approximation! Kepler later would tell one of his collaborators how best to do this approximation, which would remain the best method up to 1801. But, to Kepler, this problem was never about finding some way to approximate a number. Reformulated, this is now known as *Kepler's Problem*:

*Given the area of part of a semicircle and a point on the diameter; to find the arc and the angle at that point, the sides of which angle, and which arc, encloses the given area.*<sup>19</sup>

This problem is of the same class studied by Cusa, and Kepler's friend John Napier, and was later called *Transcendental* by Leibniz. In Cusa's mind, the relationship between the circle and its diameter was a reflection of the relationship between the mind of the Creator to the mind of Man. Mathematics was thus no more than an inadequate metaphor. All mathematics could do, was provide a rough mnemonic device by which to remember the relationship, because there was a domain of the universe which was above that which could be calculated. Kepler later applied Cusa's method, and showed how the created universe represents itself to Man in the motions of the heavenly bodies, and demanded a new mathematics that was better suited to the investigation.

This is what Galileo and then Descartes were invented to prevent. Humans could have no knowledge, that they could seek and know how God's universe worked! Some less famous people did different things to dodge the problem. Newton's promoter John Keill gave some examples of this in his posthumously published lectures on astronomy at Oxford. Keill said that, since Kepler had been unable to provide a geometrical solution to his problem, his successors said he was "so fond of physical Causes, that he had departed from *Geometry*; and they blamed his *Astronomy*, as not being geometrical, since it was founded on such a Theory."<sup>20</sup> Keill pointed out that astronomers of the mid to late 17th Century used ellipses, but they still *placed an equant at the focus opposite the*

19. Johannes Kepler, *New Astronomy*, p. 600, Book 6, Ch. 60. See the New Astronomy webpage at <http://wlym.com/~animations/newastronomy.html>.

20. John Keill, *An Introduction to the True Astronomy: or, Astronomical Lectures, read in the Astronomical School of the University of Oxford* (London: 1739) p. 288.

*Sun!* Keill then proceeded to give several approximate solutions to the problem, as determined by his collaborators Halley, Seth Ward (1617-89), and Newton himself.

Instead of dodging the question, Leibniz posed a problem for all European scientists to solve: *If two points are given in a vertical plane, to assign to a mobile particle the path along which, descending under its own weight, it traverses the space between the points in the briefest time.*<sup>21</sup> He had already solved the problem, and knew it dealt with the same transcendental problem posed by Kepler, and the solution was one of the curves banned by Descartes. He and his collaborators went on to discover the mathematics that Kepler had asked for, while refuting Descartes for entertainment.

Keill left this discussion out. He and his collaborators and “intellectual” ancestors, instead, had busied themselves with trying to bury Kepler’s harmonic challenge. First, they invented “gravity,” so nobody had to deal with the “God stuff” anymore. Then, they invented Newton’s “calculus,” so they could appear to have a solution to the problem. This calculus, as opposed to Leibniz’s, was little more than an excursion into infinite number series. David Gregory’s uncle James, who had been trained at the Venetian University of Padua, apparently gave Newton his first “series expansions” of the transcendental trigonometric functions. For example, the Sine function can be numerically approximated with the series

$$\sin x = x - \frac{x^3}{1 \cdot 2 \cdot 3} + \frac{x^5}{1 \cdot 2 \cdot 3 \cdot 4 \cdot 5} - \frac{x^7}{1 \cdot 2 \cdot 3 \cdot 4 \cdot 5 \cdot 6 \cdot 7} + \text{etc.}$$

As Keill proceeded to show in his astronomy lecture, the trigonometric function in *Kepler’s Problem* could just be replaced by the first two terms of this series. That’s close enough.

Leibniz also looked at infinite series like this, but with a different idea. While the Newtonians were very pleased with themselves, that they could treat transcendental functions as deviations from the real laws of the universe, and could reduce everything to algebra problems again, Leibniz saw these series as an important reflection of a higher principle. In his account of how he discovered the calculus, Leibniz laid the real issue on the table:

[T]he new discoveries that were made by the help of [Leibniz’s] differential calculus were hidden from the followers of Newton’s method, nor could they produce anything of real value nor even avoid inaccuracies until they learned the calculus of Leibniz, as is found in the investigation of the catenary as made by David Gregory [emphasis added].<sup>22</sup>

21. See the development of this in the dialogue by Michael Kirsch and Aaron Yule, “Experimental Metaphysics: On the Subject of Leibniz’s Captive,” *Dynamis*, Vol. 1, No. 1 (2006).

22. Gottfried Wilhelm Leibniz, *Historia et Origo Calculi Differentialis*, as found in *The Early Mathematical Manuscripts of Leibniz*, translated by J.M.

No infinite algebra equation can equal a transcendental function, and this prevented Newton’s followers from making any substantial advances. This consideration would lead later into Gauss’s study of the hypergeometric series.

A century later, as Gauss would comment in his book *Theoria Motus* on the *Kepler Problem*:

Astronomers are in the habit of putting the equation of the centre in the form of an infinite series proceeding according to the sines of the angles . . . each one of the coefficients of these sines being a series extending to infinity according to the powers of the eccentricity. We have considered it the less necessary to dwell upon this formula for the equation of the center, which several authors have developed, because in our opinion, *it is by no means so well suited to practical use*, especially should the eccentricity not be very small, as the indirect method, which, therefore, we will explain somewhat more at length in that form which appears to us most convenient [emphasis added].<sup>23</sup>

The method Gauss presents afterwards was the first improvement on what Kepler did, and remains to this day the most accurate solution for the problem.

## Kepler’s Works

Cusa had shown that, in order to have a nation of people who can govern themselves and prosper, it were necessary for those people to be educated, and to see that the prosperity were caused by the development of their minds. On the other hand, the Venetian oligarchy knew that, were they to crush Cusa’s nation-state policy, they would have to crush the optimism of science. Since that didn’t exactly work, the Venetians adopted Sarpi’s policy of empiricism during the Thirty Years’ War, which meant the adoption of the scientific discoveries, but the burial of the discoverers.

Thus, at the end of Leibniz’s life, he became the target of the attack by the Venetian apparatus which had been set up in London since the 1689 Glorious Revolution. This manifested itself in the public propaganda operation to push Newtonianism in Europe and to demoralize the population through emphasizing degrading entertainment,<sup>24</sup> and by turning public

Child (London: Open Court Publ. Co., 1920), p. 27. The translator littered this translation with footnotes, some of which are helpful, but he obviously hates Leibniz. Child wrote another book, claiming to prove that both Leibniz and Newton had gotten everything from another, lesser known mathematician, Isaac Barrow (1630-1677), who resigned his position as the Lucasian chair to make way for Newton.

23. Gauss, *Theoria*, sec. 11, p. 12.

24. One might notice the extremes of entertainment in popular culture today. The common entertainment for an everyday high school boy today, is graphically killing thousands of people in first person shooter videogames, like Microsoft’s “Counter-Strike.” LaRouche points out that these games break

opinion against those people who threatened to awaken the scientific spirit of human civilization. The result of this was shown in the fight to publish Kepler's collected works.

Kepler's collection of writings and letters was taken to Königsberg by his son Ludwig after his death. Ludwig was not much of a scientist, and did not see the significance of his father's works, and thus died before making them public. Four decades passed before Johannes Hevelius (1611-87) made the effort to procure the works for himself. Hevelius lived in Danzig, Poland, and had produced naked-eye star maps that rivaled Tycho Brahe's in precision. He became embroiled in an argument with the British Royal Society's Robert Hooke in the late 1670s, who criticized his maps because he hadn't used a telescope. Edmund Halley was sent to Danzig to confront the astronomer in 1679, but Halley returned with the news that Hevelius's method of measuring positions was more accurate than any Englishman had done with a telescope. Later that year, Hevelius's house, library, and observatory were burned to the ground.<sup>25</sup> Among the few things that survived, by the grace of God, were the Kepler manuscripts.<sup>26</sup>

Hevelius also died before his planned publication, and the manuscripts were again dispersed. They fell into the hands of Gottfried Kirch (1639-1710), a student of Hevelius; Ernst Lange, the son-in-law of Hevelius; and, later, Ulrich Junius (1670-1726), a mathematician and calendar-maker at the Berlin Academy. Both Kirch and Junius were interested in getting a look at the original version of Kepler's *Rudolphine Tables*, so they could make it big in the ferment around calendar reform. Junius succeeded in printing up one volume of Kepler's work, but this only contained what Junius thought was pertinent to the furthering of mathematics. This publication caught the attention of a scientist in Leipzig, Michael Gottlieb Hansch (1683-1749), who thought Junius had marred Kepler's works through his selective editing.

Hansch obtained the works for himself, through the aid of Leibniz. Leibniz was then in the employ of the Kingdom of Hanover, researching the history of the royal family, and had succeeded in demonstrating the right of succession of the Hanoverian monarch to the throne of England after the death of Queen Anne. His dream was a planet of nation-states, cooperating for scientific and technological development, and the en-



*Gottfried Wilhelm Leibniz: statesman, scientist, philosopher, and revolutionary. He helped to preserve Kepler's legacy from destruction, and paved the way for Gauss.*

noblement and education of the growing populations. He initiated the building of a network of scientific academies in the major capitals of Europe, and became a top advisor of several monarchs. A wonderful part of his dream would have been the publishing and distributing of the ideas of Kepler, who had informed much of his conceptions of the universe.

Hansch succeeded in binding the set of manuscripts in 20 volumes, labelled "Manusc. Kepplerianorum," plus two smaller books. Leibniz advised him to take the work slowly and thoroughly, so that he wouldn't

make any mistakes. Inspired by this, Hansch excitedly asked the Elector of Saxony, August the Strong, for permission to voyage to England, France, and Italy, so he could study astronomy and mathematics at the top universities. August granted his permission, and even promised his special pass, but then revoked it when the University of Leipzig, where young Hansch was studying, requested that Hansch stick around to finish his Doctor of Theology program.

In 1713, Leibniz went to Vienna as the Imperial Privy Counselor to the Holy Roman Emperor, Charles VI, and succeeded in securing permission for Hansch to go with him, in order to further the printing project. Here, although Leibniz got the Emperor interested in the Kepler project, it was slow going. Leibniz was dedicated to his real reason for being in Vienna—to set up a link in his academy network—and the financial and material support Hansch found there were not wholly adequate. By late 1714, Leibniz left Vienna, returning to Hanover, expecting to be taken with the new King of England, George I, whose right to the crown had been won by Leibniz. To alleviate some of the slowness of the massive editing process, Leibniz advised Hansch to focus on the unpublished letters, and Kepler's last work, the *Hipparchus*, to generate interest and, thus, more opportunities for funding.

Hansch received his last stipend from the Emperor just before Leibniz died. While still editing the letters, he went immediately to Württemberg, to research Kepler's life for a biographical sketch. As soon as he got back to Vienna, he got the first edition of Kepler's letters printed. This was the last thing he ever printed, as the interest in the work, and thus the assistance he got from the royal court, collapsed. The romance of the Enlightenment was taking over Europe. As soon as Leibniz died, that chameleon, Conti, showed up at the court of Hanover, which had been deserted, except for Leibniz, when King George I moved to England. Conti sifted through Leib-

---

down the barriers in young people towards killing others, at the same time that they teach kids to aim accurately at the head and shoulders. These games were designed with this intention, and are being promoted to create a new Roman-style army of heartless killers, fit to shoot often and accurately for an empire. The effects can be seen in the recent Virginia Tech mass murder, by a young man who had trained on "Counter-Strike." Lets ban these things!

25. A British hand might be surmised in this tragedy, but the culprit was actually one of Hevelius's disgruntled servants. It wouldn't have been the first time that the British had hired a hit man, though!

26. Information on Hevelius can be found on the website of the Students for the Exploration and Development of Space <http://seds.lpl.arizona.edu/messier/xtra/Bios/hevelius.htm> .

niz's works, plucking out "anything that had to do with the Calculus controversy," and then left just before the King confiscated everything.

Hansch believed that the loss of support for his Kepler project, was due to the loss of interest in real science by the royalty. In fact, the project to set up a scientific academy in Vienna, for which Leibniz had full support from the Emperor, came to a halt, and was not restarted for over 130 years. Hansch found that the philosophy of his former teacher was also being twisted, by a former "friend," Christian Wolff (1679-1754). Hansch sent a series of furious letters to Wolff, over the publication of Wolff's watered down interpretation of Leibniz. Hansch became demoralized, and bankrupt, in defending and promoting Leibniz and Kepler. In 1721, he sold off 20 volumes of his bound manuscripts, and sold the other two to the Royal Library in Vienna. He spent the rest of his life trying to get the manuscripts back, as he feared they would fall into the hands of someone who did not understand the importance of Kepler for humanity. He found no support for his efforts, and died in 1749.

Hansch's bound collection of manuscripts popped up again in 1765, when Christoph Gottlieb von Murr found them in the trunk of the Nuremberg Warden of the Mint, who would part with them only for a high price. Von Murr wrote letters to every academic society in Europe to find someone who would purchase the works of Europe's greatest astronomer. Johann Heinrich Lambert (1728-77), a worshipper of Newton at the Berlin Academy, said he'd be surprised if anybody bought the manuscripts, as they were only fit to be museum pieces. In 1773, Catherine II of Russia was advised by Leonhard Euler to finally purchase them, with jewels, in order to donate them to the St. Petersburg Academy.<sup>27</sup>

The scientific environment of Europe had changed drastically during this period. The scientific tradition of Leibniz and Kepler had been severely tarnished, and people were becoming scientifically demoralized, except for the resistance and scientific luminosity of a small group of conspirators centered at Göttingen University, around Abraham Kästner, and, in what would soon be the United States, around Benjamin Franklin.

## The State of Astronomy

Since Leibniz's death, an avalanche of textbooks on astronomy and physics had been written, all interpreted according to Newton's laws. For example, Joseph Louis Lagrange (1736-1813), whom Napoleon would later call the "Great Volcano of the Mathematical Sciences," produced a physics textbook called *Mécanique Analytique*, in 1788. He bragged that, in it, he had reduced physics to a branch of pure mathematics, and was especially proud that it contained no diagrams. Similarly, Pierre-Simon Laplace (1749-1827) wrote his *Mécanique Céleste*, which was yet another Newtonian astronomy text-

27. *Göttinger Gelehrte Anzeigen*, Aug. 27, 1774.

book. Laplace was seen as quite strange, and put forth the theory that, if the position and momentum of every particle in the universe were known at any one time, then every event in the past and future could be calculated with Newton's Laws.

The Newton dogma was finding difficulty holding its ground against experimental evidence. There were some holdouts, such as at the Berlin Academy. But, scientific optimism further grew upon the news of the successful American Revolution, whose Constitution would be based on the ideas of Leibniz. It was quite obvious to people like Kästner and Franklin, that Newtonianism was not science. Since Newton had died in 1727, a whole new generation of scientists had emerged. Many of these youth attended Kästner's classes on astronomy, or played with Franklin's electricity experiments.

One of Kästner's students was Heinrich Wilhelm Olbers (1758-1840), who made his career as a physician, and worked on astronomy at night. Olbers made a breakthrough in the determination of comet orbits in 1797. In astronomy, new observations were piling up. One popular activity at the time was comet hunting, and whenever a new comet was discovered, there was a race to determine its trajectory. Charles Messier (1730-1817) blazed the path for telescopic comet hunting, locating 45 different comets between 1758 and 1801. Early on, Messier kept finding other fuzzy things besides comets, since he was using a telescope, and finally produced a catalog of these "nebulae" to help other comet hunters.<sup>28</sup>

One night in 1781, while producing a very accurate star map, the astronomer and organist William Herschel (1738-1822)<sup>29</sup> spotted what he believed to be a slow-moving comet without a tail. He reported it to the Royal Society, and a half-dozen astronomers across Europe attempted to determine its orbit. Usually, the astronomer would curve-fit a parabola to the data points, since the only variable with a parabola is the perihelion distance of the object. After fitting a rough parabola, the orbital approximation was further improved by tweaking the parabola and adding new observations. Herschel's comet, however, didn't work with a parabola, so an astronomer named Anders Johann Lexell (1740-84), at the St. Petersburg Academy, tried a circle. When this worked, Lexell announced that this was not a comet, but a new planet, which was later named Uranus.

Another astronomer who spent much of his time producing star maps was Baron Franz von Zach (1754-1832), the director of the Seeberg observatory of Gotha. He was much

28. Today, this is known as the Messier Catalog, and includes the Crab Nebula and the Andromeda Galaxy.

29. William Herschel and his sister, Caroline, moved to England from Hanover, and lived in the tradition of Kepler and Bach. He supported himself as an organist while developing his career as an astronomer, and wrote several symphonies. Herschel went full-time into astronomy after his discovery of Uranus, and built more than 400 telescopes, one of which had a focal length of 12 meters and a diameter of 1.2 meters. He also discovered infrared radiation.

better known around Europe for his astronomical journals than his maps, though. His journal, the *Monatliche Correspondenz zur Beförderung der Erd- und Himmelskunde*, became one of the main clearing houses for new astronomical work in Europe, and von Zach himself thus became a convergence point for astronomical dialogue of the time. One thing that he'd picked up along the way, was what he took to be an old German legend of a missing planet between Mars and Jupiter. In the wake of the discovery of Uranus, he thought it might be worth searching for this planet. In 1798, he convened the first international conference of astronomers in Gotha, and among the astronomers there, he found five who would help track down this planet. These included Olbers. They would begin by dividing up the zodiac into six parts, and produce the most accurate star maps of this region ever.

As he related in a column in the July 1801 issue of his *Monatliche Correspondenz*, von Zach first heard of the idea of a missing planet from his friend Johann Elert Bode (1747-1826) of the Berlin Academy, who had produced a number series that gave the distances between the orbits, but included an orbit between Mars and Jupiter. Another reference to it was in a Newtonian textbook on astronomy by Lambert, who claimed it hadn't yet been found, because it had been sucked up by Saturn and Jupiter.<sup>30</sup>

Whence had Bode gotten his numerical progression? In the November 1802 issue of *Monatliche Correspondenz*, Johann Friedrich Wurm (1760-1833) laments the use of Bode's series. He says it explains nothing, since people could come up with many different numerical laws that give the same series of numbers, or any series of numbers for that matter. He goes on to point out that Bode had originally gotten it from Johann Daniel Titius (1729-96), who traced it back to the same Christian Wolff who had tried to replace Leibniz's sublime philosophy with his own interpretation. Wolff put the following quote in a book he had written on astronomy: "The planets, which move about the Sun, stand very distant from one another. If one divides the distance of the Earth from the Sun in ten parts, the distance of Mercury from it thus comes to be 4; of Venus 7; of Mars 15; of Jupiter 52; of Saturn 95..." Wurm then points out that Wolff hadn't said where he'd gotten this from, and stops his detective work there.<sup>31</sup>

But, this exact passage from Wolff appeared earlier, on page 2 of David Gregory's 1715 textbook on Newtonian mechanics, *The Elements of Astronomy*.<sup>32</sup> Is this a direct lineage

of a hack job on Kepler and Leibniz? The original idea of an exploded planet was from Kepler, whose hypothesis came, not from some number series, but from considerations of the harmonic ordering of the Solar System! First, Kepler placed a planet in this gap in his *Mysterium Cosmographicum*. Next, he investigated its anomalous harmonic characteristics in his *Harmonices Mundi*. Finally, the very same numbering in David Gregory's book appears in Kepler's *Epitome Astronomiae Copernicanae* (*The Epitome of Copernican Astronomy*). Kepler saw series of numbers like this as merely the effect of the harmonies expressed in the motions of the planets. But, these astronomers were infected by the Newton swindle.

## Ceres

When, in 1801, Giuseppe Piazzi (1746-1826) observed what he believed to be a comet, the astronomy world was caught with its pants down. Piazzi gathered observations between Jan. 1 and Feb. 11, and then ceased, upon falling ill. He sent a few of his observations to Bode and Jérôme Lalande (1732-1807),<sup>33</sup> who then told von Zach in June. From those few observations, von Zach's former student Johann Karl Burckhardt (1773-1825), who worked for LaLande at the Paris Observatory at that time, calculated a rough parabola, and von Zach's collaborator Olbers calculated a circle. In August, LaPlace claimed that the object was the comet discovered by Lexell in 1770, but its orbit had been perturbed by a close encounter with Jupiter, and hence had reappeared early. He referred to equations in his textbook to prove it. Everybody lamented the incompleteness of the observations, and the lateness of their reporting.

Finally, the complete set of observations was published in the September *Monatliche Correspondenz*, and both Burckhardt and Olbers argued that it could not be the 1770 comet, but was a microplanet between Mars and Jupiter instead. Burckhardt tried an ellipse, assuming the object was seen during its perihelion. Olbers further argued that the observations proved that the object had been seen near its line of apsides, and thus supported Burckhardt's perihelion assumption. But, Olbers thought a perfect circle was the best approximation. LaLande then showed that, if a circular orbit were assumed for Mars, an error of up to 2.5° in the anomaly of commutation could be measured.

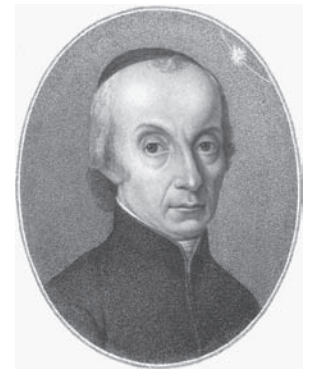

Giuseppe Piazzi gathered the observations of Ceres, that Gauss used to determine its orbit—to the frustration of Gauss's empiricist opponents.

33. LaLande was a supporter of the American Revolution, and set up a group at the Paris Academy called Les Neuf Surs, for that purpose.

30. Franz von Zach, "Fortgesetzte Nachrichten über den zwischen Mars und Jupiter längst vermutheten, nun wahrscheinlich entdeckten neuen Hauptplaneten unseres Sonnen-Systemes," in the June 1801 *Monatliche Correspondenz*, Vol. 4 (Gotha), pp. 592-623.

31. Franz von Zach, "Über die vermeinte harmonische Progression in den Planeten-Abständen, als Nachtrag zur M.C.," in the November 1802 *Monatliche Correspondenz*, Vol. 5 (Gotha), p. 504.

32. David Gregory, *The Elements of Astronomy, Physical and Geometrical* (London: 1715).

The race was on. Astronomers from London to Paris to Berlin to St. Petersburg were searching for the new object, relying on the forecasts from these hypothesized orbits. If its orbit were not calculated quickly, the chances of re-identifying it were almost zero. Yet, all discussion of the orbits and future positions hinged on various sets of assumptions. Either the object had to be near perihelion, or the eccentricity of its orbit was quite small, or some of the observations were in error. None of the calculated orbits were within an acceptable range of deviation from the data. By December, everybody was watching the skies, and the *Monatliche Correspondenz*, for signs of Piazzi's missing star, while optimism dwindled.

Then, a ray of hope appeared. The young Carl Gauss contacted von Zach with no fewer than four different attempts at calculating the orbit. His calculated orbits fit the observed data almost exactly. Gauss only needed three observations, and then checked his determination with three other observations. What is more, none of his determinations involved any assumptions whatsoever. His orbit was far different than all other hypotheses. Von Zach suggested that all those searching for the reappearance of Piazzi's star widen their search drastically, so that Gauss's forecasts could be tested. The astronomy world held its breath.

When Olbers located the planet on New Year's Day, 1802, it was precisely where Gauss said it would be. The 24-year-old astronomer had shaken the foundations of astronomy. The new object was indeed not a comet, but the first of many asteroids to be discovered, occupying the gap between Mars and Jupiter. The shooting star that had been revealed, though, was Gauss himself. Where had this genius come from? How did he come up with his hypotheses? Gauss would publish nothing on his method for determining the orbit. He proceeded to determine the orbit of the next asteroid, Pallas. Even then, when pressed by his newfound friend, Olbers, he would not make his method public. As Olbers told him, "Does it not perhaps appear otherwise (you know that I am not capable of maintaining these petty thoughts), than that you wish to keep your method private, in order to again perhaps be able to determine the orbit of a new planet discovered in the future *first and entirely independently*?"<sup>34</sup>

Gauss would never publish a comprehensive account of his discovery. In late 1802, he sent Olbers an extremely brief summary, and Olbers had to write several letters back, extracting explanations from Gauss, of the sections labelled, "as is easily seen." This summary was finally published in the *Monatliche Correspondenz*, in 1810. This was two years after Gauss took Kästner's position as head of the Göttingen observatory, and one year after Gauss published what would become the standard textbook on astronomy, the *Theoria Motus Corporum Coelestium in Sectionibus Conicis Solem Ambientium*, published on the 200th anniversary of Kepler's

publication of his *Astronomia Nova*.

To return to the introduction, the question that must be answered is, indeed, how did Gauss discover the orbit of Ceres? Even more important, why couldn't the top astronomers of the time, the experts, determine this orbit? How did Gauss think differently than all the others? These questions will be answered in the coming period, and the answers will form a useful guide for how to understand and intervene into the present international crisis. In the meantime, have fun!

## References

- G. Waldo Dunnington, *Carl Friedrich Gauss: Titan of Science* (New York: Exposition Press, 1953).
- Carl Friedrich Gauss, *Theoria Motus Corporum Coelestium in Sectionibus Conicis Solem Ambientium*, translated by Charles Henry Davis (New York: Dover, 2004).
- Johannes Kepler, *New Astronomy*, translated by William H. Donahue (Cambridge: Cambridge University Press, 1992).
- Lyndon H. LaRouche, Jr., "The Popular Pits of Current Superstition: The Dance of the Bio-Fools," *EIR*, Feb. 2, 2007.
- Lyndon H. LaRouche, Jr., "The Principle of 'Power,'" *EIR*, Dec. 23, 2005.
- H. Graham Lowry, *How the Nation Was Won* (Washington, D.C.: EIR News Service, 1987).
- David Eugene Smith, *History of Mathematics*, Vol. 1 (New York: Dover, 1958).
- David Shavin, "The Courage of Gauss," unpublished manuscript.

### On Kepler's works:

- Max Caspar, *Kepler*, translated and edited by C. Doris Hellman (New York: Collier Books, 1962), pp. 377-379.
- Detlef Döring, "Michael Gottlieb Hansch (1683-1749), Ulrich Junius (1670-1726), und der Versuch einer Edition der Werke und Briefe Johannes Keplers," *Acta Hist. Astro.* 5, Band 2 (Verlag Harri Deutsch, 2002), pp. 80-121.
- Alexandre Koyré, *The Astronomical Revolution: Copernicus—Kepler—Borelli* (New York: Dover, 1992).
- Otto Volk, *Kepleriana*, "Celestial Mechanics," Vol. 8 (Droedrecht: Reidel Publ. Co., 1973), pp. 283-289.

### On Newton's circles:

- E.T. Bell, *Men of Mathematics: The Lives and Achievements of the Great Mathematicians from Zeno to Poincaré* (New York: Simon & Schuster, 1927, 1986)
- Anita Guerrini, "The Tory Newtonians: Gregory, Pitcairne, and Their Circle," *Journal of British Studies*, 25 (1984).
- John Maynard Keynes, *Essays in Biography: Newton, the Man* (New York: Harcourt, Brace & Co., 1933).
- Michael White, *Isaac Newton: The Last Sorcerer* (Great Britain: Perseus Books, 1997).

34. Olbers to Gauss, Sept. 11, 1802.



LAROCHE'S JUNE 21 WEBCAST

# A Turning Point in History And a Dark Day for Dick

by Jeffrey Steinberg and Edward Spannaus

Before Lynon LaRouche took to the podium in Washington, D.C. on June 21 to deliver an international webcast address, he assured colleagues that his remarks would have historic significance. His promise was kept—and then some.

Washington sources have described the LaRouche broadcast, which fully exposed the role of Vice President Dick Cheney in the bungled attempt to cover up the “scandal of the century”—the BAE Systems \$100 billion secret covert operations slush fund, built on a Saudi-British arms-for-oil deal known as Al-Yamamah (“the dove”)—as the catalyst of a fundamental shift in world politics. What LaRouche’s webcast immediately triggered was an avalanche of attacks on Cheney, which has already destroyed what was left of his political career as a key thug-asset of London-centered financial circles; and a fundamental split between certain U.S.-based political factions and the British.

The consequences of LaRouche’s dead-on exposé of the Cheney-BAE nexus will also be felt on the 2008 Presidential elections, with all of the current crop of pre-candidates suddenly discredited for their cowardly evasion of this “scandal of the century.”

In stark contrast to the evasive babblings of all of the “official” candidates, Sen. John Kerry (D-Mass.) acted decisively on June 21—the day of the LaRouche webcast—by writing to Attorney General Alberto Gonzales and demanding answers to a series of questions about the Justice Department’s BAE probe. Senator Kerry, by taking up the BAE question, effectively inserted himself back into the 2008 Presidential sweepstakes, whether or not he formally decides to again seek the Democratic Party nomination. Kerry is remembered for being the only Senator to actually take up the dirty drug-money dimensions of the Iran-Contra illegal operations of the Reagan-Bush White House, with his 1987 Kerry Commission

probe, which exposed the Oliver North White House links to Colombian cocaine cartels, in financing the Nicaraguan “Contras.”

## Cheney Takes the Big Political Hit

Washington sources have confirmed that a bipartisan group of leading political “elder statesmen” have been banging their heads against a brick wall for months, attempting to get the major American newspapers, particularly the *Washington Post* and *New York Times*, to take off the gloves against Cheney. These sources credit the LaRouche webcast with breaking the logjam. “LaRouche,” one senior public servant gleefully explained, “shamed them into action. Without LaRouche’s take-no-prisoners words, the *Post* never would have gone to press with the attack on Cheney.”

The source was referring to the June 24-27, 2007 outsized series of front-page blasts at Cheney by *Post* writers Barton Gellman and Jo Becker. Most damning in the series was a detailed eyewitness account, in the first article, of Vice President Cheney’s behavior on Sept. 11, 2001, as the South Tower of the World Trade Center began to collapse, and everyone around him was reacting emotionally to the mass carnage. “Cheney made no sound. ‘I remember turning my head and looking at the vice president, and his expression never changed,’ said the witness, reading from a notebook of observations written that day. Cheney closed his eyes against the image for one long, slow blink.

“Three people who were present,” the *Post* account continued, “not all of them admirers, said they saw no sign then or later of the profound psychological transformation that has often been imputed to Cheney. What they saw, they said, was extraordinary self-containment and a rapid shift of focus to the machinery of power. While others assessed casualties and the work of ‘first responders,’ Cheney began planning for a

conflict that would call upon lawyers as often as soldiers and spies.”

Gellman and Becker concluded: “More than any one man in the months to come, Cheney freed Bush to fight the ‘war on terror’ as he saw fit, animated by their shared belief that al-Qaeda’s destruction would require what the vice president called ‘robust interrogation’ to extract intelligence from captured suspects. With a small coterie of allies, Cheney supplied the rationale and political muscle to drive far-reaching legal changes through the White House, the Justice Department and the Pentagon.”

In more blunt language, Cheney carried out precisely the “Reichstag fire” coup d’état that Lyndon LaRouche forecast a full nine months before 9/11, in a Jan. 3, 2001 international webcast, in which he branded Cheney the Hermann Göring of the incoming Bush Administration.

### **Sally Quinn Steps In**

On June 26, the newspaper’s website published an unambiguous editorial cry for Cheney’s immediate ouster, signed by no less a *Post* icon than Sally Quinn, the wife of the Washington Post Corporation’s vice president, and the paper’s former executive editor, Benjamin C. Bradlee. Under the headline “A GOP Plan To Oust Cheney,” Quinn wrote: “The big question right now among Republicans is how to remove Vice President Cheney from office. Even before this week’s blockbuster series in *The Post*, discontent in Republican ranks was rising. As the reputed architect of the war in Iraq, Cheney is viewed as toxic, and as the administration’s leading proponent of an attack on Iran, he is seen as dangerous. As long as he remains vice president, according to this thinking, he has the potential to drag down every member of the party, including the presidential nominee, in next year’s elections.”

Quinn offered: “Cheney is scheduled this summer for surgery to replace his pacemaker, which needs new batteries. So if the president is willing, and Republicans are able, they have a convenient reason to replace him: doctor’s orders.”

Well-placed Washington sources report that there is now a mad scramble at the *New York Times* to trump the *Post* series with even more damning revelations about Cheney. It was this kind of media competition that created the political climate, during the early 1970s, that brought down Richard Nixon in Watergate.

### **Kerry’s Bombshell Letter**

By the time the *Post* series began, LaRouche had clearly linked the issue of Cheney’s political survival to the unfolding of the BAE scandal. At the June 21 webcast, LaRouche had advertised the fact that Cheney was in “deep kimchee” with his London patrons, and that his failure to bury the BAE scandal would accelerate his political demise.

It was in this context that Senator Kerry’s letter to Attorney General Gonzales, demanding firm action on BAE’s

alleged bribes to Prince Bandar, hit like a bomb.

Senator Kerry reminded the AG: “It appears that U.S. officials have also been concerned about BAE’s business practices for some years. In July 2002, a State Department memorandum noted persistent allegations that BAE Systems pays bribes to obtain business. The memorandum concluded that this volume of allegations about one company would have triggered a Department of Justice criminal division investigation long ago. More recently, in October 2006, a high ranking official at the Department of Justice indicated that foreign-owned companies, such as BAE, could be targeted by U.S. investigators: the Department will not hesitate to enforce the Foreign Corrupt Practices Act, just as it does against American companies.”

After reviewing news accounts of the BAE-Prince Bandar “illegal payments,” Senator Kerry wrote, “Given BAE’s prominent role within the U.S. defense industry, their pending application before the Committee on Foreign Investment in the United States for approval of the Armor Holdings sale, and the serious nature of the allegations against the company, full disclosure of the facts is essential.” Kerry then demanded formal answers to six questions, about current and past U.S. government probes of BAE. Among the questions that must have sent Gonzales and Karl Rove both scrambling for cover: “Was the Attorney General’s office, or any other office or official in the Department of Justice, ever contacted by any other officials, agencies or departments of the U.S. government, including the White House, concerning this matter? If so please list any and all such contacts.”

The Kerry letter ended, “I look forward to a reply no later than June 30, 2007.”

In the same way that Senator Kerry’s 1980s probe, when he was chairman of the Senate Foreign Relations Subcommittee on Terrorism, Narcotics, and International Operations, amounted to a declaration of war against the George H.W. Bush- and Oliver North-run “Enterprise,” Kerry’s June 21 letter to Gonzales was widely read in official Washington as a virtual declaration of war against London.

Five days after the Kerry letter went to the Attorney General, BAE Systems formally disclosed that it had been notified by the U.S. Department of Justice that “it has commenced a formal investigation relating to the company’s compliance with anti-corruption laws including the company’s business concerning the Kingdom of Saudi Arabia.”

As reported elsewhere in this issue, the BAE admission that it was under American investigation produced a torrent of hysterical denunciations of the U.S. action and the bungling coverup attempt by British Prime Minister Tony Blair. The London *Independent* of June 30, typically railed that the U.S. DOJ probe “could, in a worst-case scenario, lead to the extradition and prosecution of BAE’s senior executives.” The paper noted that the U.S. Foreign Corrupt Practices Act (FCPA) is far more stringent than Britain’s anti-corruption laws, and

that enforcing the FCPA is a top priority of the DOJ Criminal Division head Alice Fisher.

Indeed, the Department's top corruption prosecutor, Mark Mendelsohn, a career DOJ professional who is now the deputy chief of the Fraud Section, has a well-established track record for successfully prosecuting foreign companies that have engaged in bribery on U.S. soil. Mendelsohn is also the Department's representative on the Organization for Economic Cooperation and Development (OECD) Bribery Working Group, an agency already probing the BAE case under the OECD Convention on Combatting Bribery.

Furthermore, the evidence about the BAE-Bandar relationship in the public record already points to crimes beyond the scope of the FCPA. According to Washington sources, the BAE-Bandar scheme constituted money laundering, under the 1997 U.S. law. An estimated \$2 billion, which originated in Saudi Arabia, was passed through the Bank of England, and forwarded to Prince Bandar's accounts at the now-defunct Riggs Bank in Washington.

In 2003-04, the Department of Justice conducted an exhaustive probe of Riggs Bank, triggered by revelations that \$50-70,000 had gone from Prince Bandar's account to two Saudis who were linked to a pair of the 9/11 hijackers. In February 2005, Riggs was fined \$25 million for violating money-laundering laws, and pled guilty to violating the U.S. Bank Secrecy Act. During the course of the probe, the Department of Justice confiscated all of the banking records of the Saudi Embassy, spanning much of Prince Bandar's tenure as Ambassador to the United States. Those documents, sources indicate, could spell doom for both the Saudi prince and the Vice President, because they provide a detailed paper trail of how the "Al-Yamamah" funds were spent inside the United States.

### **Demands for Cheney's Impeachment**

One of the clearest indications that politics in the United States has gone through a profound phase-change since the June 21 LaRouche webcast came on June 28, when ten-term Democratic Congressman James McDermott (Wash.) took to the House floor to call for Cheney to resign or face impeachment. "Madam Speaker," he began, "it is time for a new exit strategy, one that removes the Vice President of the United States from office, voluntarily, if he chooses, but by impeachment if he stonewalls." Citing the "dire situations in Iraq, Iran," the Congressman charged that Cheney "tramples on the Constitution like it was a doormat. . . . America would be best served by bringing forth articles of impeachment against the Vice President. . . . I believe the evidence is overwhelming. . . . Tonight it is time to say the impeachment option is on the table." McDermott signed on to H.R. 333, originally introduced by Rep. Dennis Kucinich (D-Ohio), spelling out a detailed bill of indictment for high crimes and misdemeanors by the Vice President.

In his remarks on the floor, Representative McDer-

mott acknowledged his previous stubborn refusal to join the impeach Cheney effort. "As my constituents . . . know, I have struggled mightily with this matter for a long time."

Indeed, when LaRouche Youth Movement members, backed by a crowd of angry constituents, demanded that McDermott endorse H.R. 333 at a May 31, 2007 town hall meeting in the district, he refused, claiming, "We can't do it, we don't have the votes, and they know we don't have them," parroting the line coming from Speaker of the House Nancy Pelosi.

In his floor speech on June 28, McDermott made it clear that he had gotten the message, boldly declaring, "I am adding my name to H.R. 333. . . . For the good of the nation, the Vice President should leave office immediately. Call it a medical condition, call it a political condition, call it what it is: the departure of a person who forgot that he works for the American people. The Vice President must either resign or face impeachment."

---

## Documentation

---

# Leading GOP Senators Urge Iraq Disengagement

*On June 25 and 26, two prominent Republican Senators came forward to demand that the Bush Administration change policy in Iraq, inclusive of moving toward gradual military disengagement, as well as increased diplomatic engagement. Sen. Richard Lugar (R-Ind.), the ranking Republican on the Senate Foreign Relations Committee, and a respected figure on both sides of the aisle, made his call in a speech on the Senate floor. He was followed the next day by Sen. George V. Voinovich (R-Ohio), a member of the Foreign Relations Committee, who sent a public letter and strategy paper to President Bush, outlining a comprehensive plan for gradual reduction of U.S. forces.*

*Sources on Capitol Hill tell EIR that if Sen. John Warner (R-Va.), who publicly praised Lugar's speech, were to come out with a similar demand for reappraisal, the Cheney-Bush Administration hammerlock on Iraq policy would be broken.*

*Particularly notable is the degree to which the proposals by Senator Voinovich converge on those put forward by Lyndon LaRouche in April of 2004.*

*We provide here substantial excerpts from Lugar's speech, and Voinovich's strategy paper. The full texts are available on their websites.*

# Lugar: Connecting Iraq To Our Vital Interests

Mr. President, I rise today to offer observations on the continuing involvement of the United States in Iraq. In my judgment, our course in Iraq has lost contact with our vital national security interests in the Middle East and beyond. Our continuing absorption with military activities in Iraq is limiting our diplomatic assertiveness there and elsewhere in the world. The prospects that the current “surge” strategy will succeed in the way originally envisioned by the President are very limited within the short period framed by our own domestic political debate. And the strident, polarized nature of that debate increases the risk that our involvement in Iraq will end in a poorly planned withdrawal that undercuts our vital interests in the Middle East. Unless we recalibrate our strategy in Iraq to fit our domestic political conditions and the broader needs of U.S. national security, we risk foreign policy failures that could greatly diminish our influence in the region and the world.



*Sen. Richard Lugar*

The current debate on Iraq in Washington has not been conducive to a thoughtful revision of our Iraq policy. Our debate is being driven by partisan political calculations and understandable fatigue with bad news—including deaths and injuries to Americans. We have been debating and voting on whether to fund American troops in Iraq and whether to place conditions on such funding. We have contemplated in great detail whether Iraqi success in achieving certain benchmarks should determine whether funding is approved or whether a withdrawal should commence. I would observe that none of this debate addresses our vital interests any more than they are addressed by an unquestioned devotion to an ill-defined strategy of “staying the course” in Iraq.

I speak to my fellow Senators, when I say that the President is not the only American leader who will have to make adjustments to his or her thinking. Each of us should take a step back from the sloganeering rhetoric and political opportunism that has sometimes characterized this debate. . . . I believe that we do have viable options that could strengthen our position in the Middle East, and reduce the prospect of terror-

ism, regional war, and other calamities. But seizing these opportunities will require the President to downsize the U.S. military’s role in Iraq and place much more emphasis on diplomatic and economic options. It will also require members of Congress to be receptive to overtures by the President to construct a new policy outside the binary choice of surge versus withdrawal. We don’t owe the President our unquestioning agreement, but we do owe him and the American people our constructive engagement.

## Seeking a Sustainable Policy

In my judgment, the costs and risks of continuing down the current path outweigh the potential benefits that might be achieved. Persisting indefinitely with the surge strategy will delay policy adjustments that have a better chance of protecting our vital interests over the long term.

I do not come to this conclusion lightly, particularly given that General Petraeus will deliver a formal report in September on his efforts to improve security. . . . But three factors—the political fragmentation in Iraq, the growing stress on our military, and the constraints of our own domestic political process—are converging to make it almost impossible for the United States to engineer a stable, multi-sectarian government in Iraq in a reasonable time frame.

## Iraqis Don’t Want To Be Iraqis

First, it is very doubtful that the leaders of Iraqi factions are capable of implementing a political settlement in the short run. I see no convincing evidence that Iraqis will make the compromises necessary to solidify a functioning government and society, even if we reduce violence to a point that allows for some political and economic normalcy.

In recent months, we have seen votes in the Iraqi parliament calling for a withdrawal of American forces and condemning security walls in Baghdad that were a reasonable response to neighborhood violence. The Iraqi parliament struggles even to achieve a quorum, because many prominent leaders decline to attend. We have seen overt feuds between members of the Iraqi government, including Prime Minister Maliki and Vice President Tariq al-Hashimi, who did not speak to each other for the entire month of April. The Shia-led government is going out of its way to bottle up money budgeted for Sunni provinces. Without strident intervention by our embassy, food rations are not being delivered to Sunni towns. Iraqi leaders have resisted de-Baathification reform, the conclusion of an oil law, and effective measures to prevent oil smuggling and other corrupt practices. . . .

American strategy must adjust to the reality that sectarian factionalism will not abate anytime soon and probably cannot be controlled from the top.

## Stress on the Military Instrument

The second factor working against our ability to engineer a stable government in Iraq is the fatigue of our military. The

window during which we can continue to employ American troops in Iraqi neighborhoods without damaging our military strength or our ability to respond to other national security priorities is closing. Some observers may argue that we cannot put a price on securing Iraq and that our military readiness is not threatened. But this is a naive assessment of our national security resources....

America's armed forces are incredibly resilient, but Iraq is taking a toll on recruitment and readiness....

Filling expanding ranks will be increasingly difficult given trends in attitudes toward military service. This has been measured by the Joint Advertising Market Research and Studies Program, which produced a "Propensity Update" last September after extensive research. The study found that only 1 in 10 youths has a propensity to serve—the lowest percentage in the history of such surveys. 61% of youth respondents report that they will "definitely not serve." This represents a 7% increase in less than a year. These numbers are directly attributable to policies in Iraq. When combined with the Army's estimate that only 3 of 10 youths today meet basic physical, behavioral, and academic requirements for military service, the consequences of continuing to stretch the military are dire.

The U.S. military remains the strongest fighting force in the world, but we have to be mindful that it is not indestructible. Before the next conflict, we have much to do to repair this invaluable instrument. This repair cannot begin until we move to a more sustainable Iraq policy.

### **Constraints of Our Domestic Political Timetable**

The third factor inhibiting our ability to establish a stable, multi-sectarian government in Iraq is the timetable imposed by our own domestic political process. The President and some of his advisors may be tempted to pursue the surge strategy to the end of his administration, but such a course contains extreme risks for U.S. national security. It would require the President to fight a political rear-guard holding action for more than a year and a half against Congressional attempts to limit, modify, or end military operations in Iraq. The resulting contentiousness would make cooperation on national security issues nearly impossible. It would greatly increase the chances for a poorly planned withdrawal from Iraq or possibly the broader Middle East region that could damage U.S. interests for decades.

The President and his team must come to grips with the shortened political timeline in this country for military operations in Iraq. Some will argue that political timelines should always be subordinated to military necessity, but that is unrealistic in a democracy....

In short, our political timeline will not support a rational course adjustment in Iraq, unless such an adjustment is initiated very soon.

### **Focusing on Vital Interests**

...The risk for decision-makers is that after a long struggle in Iraq, accompanied by a contentious political process at home, we begin to see Iraq as a set piece—as an end in itself, distinct from the broader interests that we meant to protect. We risk becoming fixated on artificial notions of achieving victory or avoiding defeat, when these ill-defined concepts have little relevance to our operations in Iraq. What is important is not the precise configuration of the Iraqi government or the achievement of specific benchmarks, but rather how Iraq impacts our geostrategic situation in the Middle East and beyond. The President's troop surge is an early episode in a much broader Middle East realignment that began with our invasion of Iraq and may not end for years. Nations throughout the Middle East are scrambling to find their footing as regional power balances shift in unpredictable ways.

Although the Bush Administration has scaled back its definition of success in Iraq, we are continuing to pour our treasure and manpower into the narrow and uncertain pursuit of creating a stable, democratic, pluralist society in Iraq. This pursuit has been the focal point of the Bush Administration's Middle East policy. Unfortunately, this objective is not one on which our future in the region can rest, especially when far more important goals related to Middle East security are languishing. I am not suggesting that what happens in Iraq is not important, but the Bush Administration must avoid becoming so quixotic in its attempt to achieve its optimum forecasts for Iraq that it misses other opportunities to protect our vital interests in the Middle East.

To determine our future course, we should separate our emotions and frustrations about Iraq from a sober assessment of our fundamental national security goals. In my judgment, we should be concerned with four primary objectives:

First, we have an interest in preventing Iraq or any piece of its territory from being used as a safe haven or training ground for terrorists or as a repository or assembly point for weapons of mass destruction.

Second, we have an interest in preventing the disorder and sectarian violence in Iraq from upsetting wider regional stability. The consequences of turmoil that draws neighboring states into a regional war could be grave. Such turmoil could topple friendly governments, expand destabilizing refugee flows, close the Persian Gulf to shipping traffic, or destroy key oil production or transportation facilities, thus diminishing the flow of oil from the region with disastrous results for the world economy.

Third, we have an interest in preventing Iranian domination of the region. The fall of Saddam Hussein's Sunni government opened up opportunities for Iran to seek much greater influence in Iraq and in the broader Middle East. An aggressive Iran would pose serious challenges for Saudi Arabia, Jordan, Egypt, and other Arab governments. Iran is pressing a broad agenda in the Middle East with uncertain conse-

quences for weapons proliferation, terrorism, the security of Israel, and other U.S. interests. Any course we adopt should consider how it would impact the regional influence of Iran.

Fourth, we have an interest in limiting the loss of U.S. credibility in the region and throughout the world as a result of our Iraq mission. Some loss of confidence in the United States has already occurred, but our subsequent actions in Iraq may determine how we are viewed for a generation.

In my judgment, the current surge strategy is not an effective means of protecting these interests. Its prospects for success are too dependent on the actions of others who do not share our agenda. It relies on military power to achieve goals that it cannot achieve. It distances allies that we will need for any regional diplomatic effort. Its failure, without a careful transition to a back-up policy would intensify our loss of credibility. It uses tremendous amounts of resources that cannot be employed in other ways to secure our objectives. And it lacks domestic support that is necessary to sustain a policy of this type.

A total withdrawal from Iraq also fails to meet our security interests....

### **Shifting to a Sustainable Military Posture**

Our security interests call for a downsizing and re-deployment of U.S. military forces to more sustainable positions in Iraq or the Middle East. Numerous locations for temporary or permanent military bases have been suggested, including Kuwait or other nearby states, the Kurdish territories, or defensible locations in Iraq outside of urban areas. All of these options come with problems and limitations. But some level of American military presence in Iraq would improve the odds that we could respond to terrorist threats, protect oil flows, and help deter a regional war. It would also reassure friendly governments that the United States is committed to Middle East security. A re-deployment would allow us to continue training Iraqi troops and delivering economic assistance, but it would end the U.S. attempt to interpose ourselves between Iraqi sectarian factions.

Six months ago, the Iraq Study Group endorsed a gradual downsizing of American forces in Iraq and the evolution of their mission to a support role for the Iraqi army. I do not necessarily agree with every recommendation of the Iraq Study Group, and its analysis requires some updating given the passage of time. But the report provides a useful starting point for the development of a "Plan B" and a template for bipartisan cooperation on our Iraq strategy.

We should understand that if the re-deployment of a downsized force is to be safe and effective, our military planners and diplomats must have as much time as possible to develop and implement the details. We will need the cooperation of the Iraqi government and key states in the region, which will not come automatically. The logistics of a shift in policy toward a residual force will test military planners, who have been con-

sumed with the surge. In 2003, we witnessed the costs that came with insufficient planning for the aftermath of the Iraq invasion. It is absolutely essential that we not repeat the same mistake. The longer we delay the planning for a re-deployment, the less likely it is to be successful.

### **Going on the Offensive**

The United States has violated some basic national security precepts during our military engagement in Iraq. We have overestimated what the military can achieve, we have set goals that are unrealistic, and we have inadequately factored in the broader regional consequences of our actions. Perhaps most critically, our focus on Iraq has diverted us from opportunities to change the world in directions that strengthen our national security.

Our struggles in Iraq have placed U.S. foreign policy on a defensive footing and drawn resources from other national security endeavors, including Afghanistan. With few exceptions, our diplomatic initiatives are encumbered by negative global and regional attitudes toward our combat presence in Iraq.

In this era, the United States cannot afford to be on a defensive footing indefinitely. It is essential that as we attempt to re-position ourselves from our current military posture in Iraq, we launch a multi-faceted diplomatic offensive that pushes adversarial states and terrorist groups to adjust to us. The best counter to perceptions that we have lost credibility in Iraq would be a sustained and ambitious set of initiatives that repairs alliances and demonstrates our staying power in the Middle East.

The Iraq Study Group report recommended such a diplomatic offensive, stating "all key issues in the Middle East—the Arab-Israeli conflict, Iraq, Iran, the need for political and economic reforms, and extremism and terrorism, are inextricably linked." The report stressed that diplomacy aimed at solving key regional issues would "help marginalize extremists and terrorists, promote U.S. values and interests, and improve America's global image."

A diplomatic offensive is likely to be easier in the context of a tactical drawdown of U.S. troops in Iraq. A drawdown would increase the chances of stimulating greater economic and diplomatic assistance for Iraq from multi-lateral organizations and European allies, who have sought to limit their association with an unpopular war.

A first step is working with like-minded nations to establish a consistent diplomatic forum related to Iraq that is open to all parties in the Middle East....

### **The Elephants in the Room**

A diplomatic offensive centered on Iraq and surrounding countries would help lift American interests in the Middle East. But credibility and sustainability of our actions depend on addressing the two elephants in the room of U.S. Middle

East policy—the Arab-Israeli conflict and U.S. dependence on Persian Gulf oil. These are the two problems that our adversaries, especially Iran, least want us to address. They are the conditions that most constrain our freedom of action and perpetuate vulnerabilities. The implementation of an effective program to remedy these conditions could be as valuable to our long-term security as the achievement of a stable, pro-Western government in Iraq.

The Arab-Israeli conflict will not be easily solved. Recent combat between the Hamas and Fatah Palestinian factions that led to Hamas' military preeminence in the Gaza Strip complicates efforts to put the peace process back on track. But even if a settlement is not an immediate possibility, we have to demonstrate clearly that the United States is committed to helping facilitate a negotiated outcome. Progress in the Arab-Israeli conflict would not end the sectarian conflict in Iraq, but it could restore credibility lost by the United States in the region. It also would undercut terrorist propaganda, slow Iranian influence, and open new possibilities related to Syria.

Clearly, the United States does not have the influence to solve the Arab-Israeli conflict unilaterally. In contrast, our dependence on Persian Gulf oil is largely within our capacity to fix. Do not underestimate the impact on Iran and other nations of a concerted U.S. campaign to reduce our oil consumption. A credible, well-publicized campaign to definitively change the oil import equation would reverberate throughout the Middle East. It would be the equivalent of opening a new front in Middle Eastern policy that does not depend on the good will of any other country....

## Conclusion

Mr. President, the issue before us is whether we will re-focus our policy in Iraq on realistic assessments of what can be achieved, and on a sober review of our vital interests in the Middle East. Given the requirements of military planners, the stress of our combat forces, and our own domestic political timeline, we are running out of time to implement a thoughtful Plan B that attempts to protect our substantial interests in the region, while downsizing our military presence in Iraq....

If we are to seize opportunities to preserve these interests, the Administration and Congress must suspend what has become almost knee-jerk political combat over Iraq. Those who offer constructive criticism of the surge strategy are not defeatists, any more than those who warn against a precipitous withdrawal are militarists. We need to move Iraq policy beyond the politics of the moment and re-establish a broad consensus on the role of the United States in the Middle East. If we do that, the United States has the diplomatic influence and economic and military power to strengthen mutually beneficial policies that could enhance security and prosperity throughout the region. I pray that the President and the Congress will move swiftly and surely to achieve that goal.

## Voinovich: The Way Forward in Iraq

It is in our nation's security and economic interests to begin to change our strategy in Iraq and initiate a plan for a responsible military disengagement. We have lost 3,530 lives to military operations in Iraq. We have spent over \$378 billion plus the funds that were appropriated in the most recent supplemental bill. Our national debt is rising and our government is being forced to abandon critical domestic priorities. Our public image to the world has deteriorated drastically and continues to suffer. If we proceed on the current path, we will endanger our nation's long-term competitiveness and well-being. Moreover, political realities in Washington will force change. As we approach the 2008 presidential election campaign, the people of the United States may choose to elect a President that promises an immediate withdrawal. This could be very dangerous for the region and American national security interests. Therefore, it is time to deal with the realities—the inevitability of our eventual disengagement—and begin the planning for a new way forward in Iraq.



*Sen. George Voinovich*

## Military Disengagement Does Not Equal Abandonment

It is absolutely critical that we avoid being forced into a precipitous withdrawal, whether it is because of world events or our own political atmosphere at home. The dangers of a precipitous withdrawal include the potential destabilization of the region; the disintegration of United States relations with various allies in the region; the endangerment of vital energy supplies in the Middle East; and irreparable damage to the credibility of the United States throughout the world (especially if we leave and a humanitarian crisis ensues). If we lose the opportunity to implement a responsible military disengagement on our own terms, we may find ourselves unable to prevent the aforementioned dangers. Therefore, we must formulate a strategy for disengagement that seeks to prevent these outcomes and protect our long-term, strategic interests in the region.

While our men and women in the field courageously fight day in and day out, complex power struggles in the region

and among Iraq's religious sects and political factions continue to undermine American troops. Iraq's elected government has not yet proved capable of forging a political reconciliation and winning the support of these groups. Following the second attack on a Shiite shrine in Samarra, Iraq's government has grown increasingly nervous as political factions split even further. Shiites are now fighting with Shiites in neighborhoods that were previously calm. According to the testimony of numerous experts and officials who have testified to the Senate Foreign Relations Committee and the Senate Armed Services Committee, Iraq's problems cannot be solved with a military solution alone. Rather, Iraq's future rests largely on political solutions within the Iraqi government, its perceived leaders and Iraq's neighboring countries where American influence is limited. Currently, the only leverage we have to influence these actors and trigger political cooperation is through the presence and/or removal of our military forces from Iraq.

Unfortunately, the presence of American forces in Iraq is being exploited by Iraq's political actors, religious sects, and militias, as well as al-Qaeda, other foreign fighters, and Iraq's neighboring countries. Their leaders are not moving quickly to make responsible decisions and change the situation, because the continued presence of American forces fuel their arguments and make compromise unnecessary. Therefore, our best chance of stabilizing Iraq is to develop and implement a strategy for United States military disengagement that is coupled with a robust diplomatic effort to contain instability and protect our interests in the region. It is time the Iraqi government and its regional neighbors take a greater responsibility in stabilizing this situation. Military disengagement is the only way to force Iraq's leaders and neighboring countries to make the difficult decisions needed to create stability and prevent a catastrophe in the region. . . .

Military disengagement cannot be viewed as an abandonment of Iraq or our long-term strategic interests in the region. If we pursue a well-developed and comprehensive plan for withdrawing U.S. forces, we will have a better chance of achieving our goals and sustaining domestic support for a continued commitment in the future. Drawing out our current efforts indefinitely will deplete our resources and limit our options when we eventually decide to draw down our forces. By forming the strategy now, we have time on our side and can mitigate the possible negative consequences of our departure.

### **What Is the Way Forward? A Clear Announcement and a Clear Commitment**

The United States should begin by issuing a clear announcement about the intention to responsibly withdraw our military forces from Iraq, while stressing our commitment to remain engaged in Iraq's future and the future stability of the Middle East. The statement should and must go

hand in hand with a demonstration of our decision, to ensure that it is taken seriously. The demonstration could be to draw back a significant number of our forces to major military garrisons or to redeploy them to forward operating bases in neighboring countries. The goal would be to reduce our visible presence, while sustaining our ability to respond immediately to any serious crisis or attack on U.S. soldiers or installations.

The announcement should also be coupled with an expression of our commitment to Iraq's future and our determination to stay involved in the region and prevent its destabilization. We must make clear that our decision to leave is based on a desire to bring an end to the violence, to force out foreign fighters, and to allow Iraqis to reclaim their country from terrorists and militants. We must also emphasize that we will come to Iraq's assistance if asked, and that we will remain in the region to assist our other allies as well.

Lastly, we should make clear our pledge to provide Iraq with our financial and humanitarian assistance for the next several years, including a special program for assisting refugees who have left Iraq and refugees who want to return to Iraq when the violence stops. Prior to the announcement, we should have a plan in place to resettle a portion of Iraqi refugees in the United States, especially those who helped U.S. forces as linguists, informants, or in other ways.

### **An International Conference and Shuttle Diplomacy**

Military disengagement must go hand-in-hand with a plan for robust diplomatic engagement aimed at preventing instability and leveraging Iraq's neighbors to help us prevent chaos in the region. On the multilateral front, the United States should organize an international conference to bring together Iraq's neighbors, the five permanent members of the UN Security Council, and the UN Secretary General. The purpose of the conference would be to discuss how to maintain stability in the Middle East, manage the refugee crisis, and forge a new political compact in Iraq that will address key political issues in Iraq, including resource allocation, de-Baathification, and reconciliation. The conference should aim to produce an agreement among its participants and a subsequent UN Security Council Resolution. The agreement should establish agreement on a number of important issues, including respect for Iraq's sovereignty and its current borders, and any arrangement to provide an international peacekeeping force if sectarian conflict leads to a humanitarian crisis. . . .

### **A Substantial Package of Foreign Aid**

The way forward and out of Iraq will require a substantial aid package for Iraq. This is an important step and



will send a clear message that we intend to keep our promise to the Iraqis and help stabilize their country. We will also need to provide foreign aid to key partners in the region, such as Jordan and Kuwait, who will be impacted strategically and economically by military disengagement. This must include refugee assistance and increased economic and security assistance to help them deal with the thousands of Iraqi refugees and manage security at their borders. It is a sign of goodwill that advances U.S. interests by helping to protect our partnerships and prevent the spread of instability through the region. Though some may balk at the expense of foreign aid to Iraq or other partners, it is only a fraction of the costs of sustaining war operations.

### **Sustain U.S. Credibility and Bolster Public Diplomacy**

As a final and critical component of any plan for military disengagement, we must find ways to restore our credibility and standing in the world. The war in Iraq was a major blow to our soft power and public diplomacy. It cannot be rebuilt overnight, but steps should be taken to prevent the further deterioration of our image in the aftermath of a withdrawal. First, we should follow up our disengagement from Iraq with an announcement of our commitment to remain involved in the greater fight against terrorism and to engage more heavily in Afghanistan and the Global War on Terrorism. We should devote more resources to strangling terrorist financial networks, promoting international law enforcement cooperation, and ridding countries of dangerous Madrassas that train terrorists. Second, we should give a visible priority to the Middle East Peace Process and our relations with all countries in the Middle East. We must show that our disengagement from Iraq does not represent an abandonment of our commitment to stabilize the Greater Middle East. Third, we should pursue a significant foreign aid program that will draw attention to the United States' good works and involvement in the world. This could begin with our commitment to pay the full amount of our current outstanding dues to the UN for international peacekeeping and other arrears, which would send a powerful message to the world and bolster the American image tremendously.

### **Conclusion**

I believe that we can set our nation on a new course in Iraq that has bipartisan support in Congress and sustains our commitment to the people of Iraq. We can share more of the responsibility with Iraqis and their neighbors, while protecting our vital interests. We must begin the process now. The United States is a powerful and principled nation, and we are entering just one more phase of our nation's history. Our courage and resolve can carry us through this experience and into a new phase of global leadership.

# Dick Cheney's War Is Driving Troops Crazy

by Carl Osgood

Dick Cheney's war in Iraq is not only imposing life-long costs, resulting from the physical injuries that many soldiers and Marines are suffering in Iraq, it is also leaving serious mental scars on many combat veterans that, like the physical wounds, will have life-long implications. The Defense Department's own reports, which may not even tell the entire story, paint a picture of a problem of huge proportions, and indicate measures needed to reduce the stress on both the force as a whole, and on individual soldiers and Marines. But these measures will not be taken unless there is a change in leadership and policy at the top.

The mental health implications of the war in Iraq are so serious, that House Oversight and Government Reform Committee chairman Henry Waxman (D-Calif.) called it "a public health problem of enormous magnitude," during a hearing on May 24. Waxman put into the hearing record a memorandum from the Los Angeles County Department of Mental Health that reported that some local providers, who work exclusively with veterans of Iraq and Afghanistan, are seeing an incidence rate of mental illness as high as 80%. The memorandum cited one case of a 24-year-old veteran of two tours in Iraq, who came home with post-traumatic stress disorder (PTSD), "and saw his life enter a downward spiral of substance abuse, homelessness and crime." According to the Veterans Health Administration, of the 229,015 veterans of the Iraq and Afghanistan wars that have sought medical care at Veterans Affairs facilities, as of December 2006, 83,889, or 37%, received a diagnosis of, or were evaluated for, a mental disorder. Steve Robinson, an independent consultant on veterans affairs frequently quoted in the press, told *EIR* on June 27 that "the mental health issues coming out of this war are staggering and will outpace anything we've seen since Vietnam."

The military services have been attempting to maintain combat operations and occupation forces in Iraq and Afghanistan on a manpower pool limited by the strictures of the all-volunteer force. That policy was questioned in a remarkable article that appeared in the July-August 2006 issue of *Military Review*, the professional journal of the U.S. Army Combined Arms Center at Fort Leavenworth, Kansas, which argued that the all-volunteer military is a failure, "that awaits truth or tragedy for confirmation." Maj. Gen. Walter L. Stewart, Jr., wrote that the all-volunteer force "relies on fewer and fewer to bear the blood burden of defense, absolves the many of any fiscal,



DoD/Sgt. Jeffrey Alexander

*The magnitude of the mental health crisis among Iraq and Afghanistan forces has been dubbed by Rep. Henry Waxman as “enormous,” and by a veterans affairs consultant as “staggering” and outpacing “anything we’ve seen since Vietnam.” Shown here, U.S. forces in Adhamiya, Iraq, May 2007.*

physical or mental hardships, and in a dawning age of asymmetric, non-state, and ascendant-state warfare, denies human power in favor of a near mystical belief in technology.” Two reports released by the Pentagon in recent weeks provide evidence that one of the consequences of trying to run these wars with an all-volunteer force is the collapse of the mental health of many of those troops.

## The Intensity of Combat

On May 4, the Army released its fourth Mental Health Advisory Team (known as MHAT IV) report, based on anonymous surveys filled out by 1,320 soldiers and Marines who were deployed in Iraq in September of 2006. Among the central findings of the report are:

- those who have deployed to Iraq more than once, report higher acute stress than first-time deployers;
- soldier suicide rates are roughly 50% higher in Iraq than the Army average;
- 10% of soldiers and Marines reported mistreating Iraqi non-combatants, and even more reported that they would not report a fellow soldier or Marine for doing the same.

The report made several recommendations involving improved training and improved access to behavioral health providers; the recommendation that would probably have the greatest impact, but is also least likely to be implemented, is increasing the time between deployments to 18 to 36 months, or decreasing deployment length.

The Army is instead going in the opposite direction. Com-

bat tours in Iraq were recently extended from 12 months to 15 months and Acting Army Secretary Pete Geren has even hinted that tours could be extended to 18 months. Acting Army Surgeon General Maj. Gen. Gale Pollock, briefing reporters on May 4 on the MHAT IV report, acknowledged the point made by others, that the Army is spread very thin, “and we need it to be a larger force for the number of missions that we are being asked to address...” She also acknowledged that because the Army is spread so thin, the recommendation for longer time between deployments was not accepted.

The MHAT IV report makes a related point that shows even further the folly of attempting to run the war the way that the Cheney-Bush Administration has been doing it. The report points out that any time a soldier or Marine leaves his base camp, he or she is immediately “at the front,” and this has “important implications for sustaining their mental health and well being.” The report notes that “a considerable number of soldiers and Marines are conducting combat operations every day of the week, 10-12 hours per day, seven days a week for months on end. At no time in our military history have soldiers and Marines been required to serve on the front line in any war for a period of 6-7 months, let alone a year, without a significant break in order to recover from physical, psychological, and emotional demands that ensue from combat.” The report ridicules the notion that the intensity of combat operations in Iraq is not comparable to that of previous wars. “Being in mortal danger for hours on end, every day of the week, for months at a time is at best physically exhausting and mentally draining.” Add to that, the traumatic experiences that are typical of combat, and “one can then begin to see that there is little distinction between the impact that combat has on the mental health of soldiers and Marines in Iraq and that of other wars the U.S. has fought.”

## Insufficient Mental Health Resources

The problems that Waxman, Robinson, and others cited are compounded by the fact that the military services do not have the resources to provide the kind of care that combat veterans need. Another report, that of the Defense Department’s Mental Health Task Force, released on June 15, makes the point: “The single finding that underpins all others in this report is that DoD currently lacks the resources—both funding and personnel—to adequately support the psychological health of service members and their families in peace and conflict.” There simply are not enough mental-health professionals with military qualification available to identify all those who need help, and to give them the help they need. The problem is exacerbated by the fact that mental-health professionals are leaving the military for the same reasons other people are, including the fact that they are also under the same stress of repeated deployments. “The number of active duty mental health professionals is likely to continue to decrease unless incentives change,” the report warns.

The consequence of not having enough mental-health

providers in the military is that people with problems will be dealt with in other ways. Commanders are not educated on the signs and symptoms of mental illness, so they may not recognize problems when they occur. Some commanders may ignore the fact that some of their people should not be deployed. Commanders are under tremendous pressure to provide combat-ready units and do not have time or competence to act as case managers for soldiers in their units who may be having problems related to combat experience. Commanders are then left with the choice of getting rid of a problem soldier so that he or she can be replaced. At that point, the soldier may be placed on medical hold status, or administratively separated from the unit. Trauma-related problems can also manifest themselves as disciplinary problems and commanders tend to respond to such problems with punishment.

The Army has recognized that it has a problem in this area and has begun implementing plans to train every soldier, from senior leaders down to platoon sergeants, to recognize the signs of PTSD. The establishment of "Warrior Transition Units" at Walter Reed Army Medical Center and at other Army hospitals has also made it easier to take soldiers out of their units and put them somewhere where they can get the rehabilitation they need. "It's a definite improvement" says Robinson, but it took four years and a scandal ignited by the *Washington Post* to get it started.

According to Robinson, the Marines have a bigger problem. He just recently returned from a visit to Camp Pendleton, California, where he found that the Marines have the same problems that the Army does, such as a lack of capacity to handle the demand for mental-health services, but that they are much harder on their people. Because of the lack of resources and the lack of training of leaders, commanders tend to respond to problems resulting from exposure to combat trauma as if they were disciplinary problems. Robinson reported that he was told that Marines have spent up to 72 days in the brig with PTSD without receiving help, "which makes it even worse," he said. The good news, Robinson said, is that there are leaders in the Marine Corps who recognize that drug and alcohol problems are often related to a Marine's war experience. The challenge is to institutionalize that recognition throughout the Corps.

Camp Pendleton has issued a statement denying Robinson's allegations, but the Marine Corps has, in fact, taken some of the same measures that the Army has taken to alleviate problems stemming from exposure to combat trauma. But the issue is structural, and includes how the Bush Administration justified the war to begin with. "When you're put into a situation where you don't understand why you're there, you can't understand the mission, you can't find meaning, your tours are getting extended, people are getting killed. . . . It all adds up and it has physical and psychological consequences," says Robinson. He says the MHAT study bears this out with its finding that a disturbing number of soldiers and Marines in Iraq think it is okay to torture Iraqis under certain circumstances.

## Conyers, Moore Promote Universal Health Care

by Patricia Salisbury

Rep. John Conyers (D-Mich.), sponsor of H.R. 676, "The United States National Health Insurance Act," held a standing-room-only event June 20 in Washington, D.C., with filmmaker Michael Moore, to announce the escalation of the mobilization for universal health care in the United States. Moore's new movie, "Sicko," on the U.S. health-care disaster, was the result of an e-mail he sent out, soliciting health-insurance horror stories, to which he received 25,000 replies in less than one week. Several of the individuals featured in the movie, and their families, were present to give personal testimony, and clips of the movie were shown. Testimony and support were also provided by dozens of organizations and health-care professionals including Physicians for a National Health Plan, National Physicians Alliance, California Nurses Association, National Nurses Organizing Committee, and the American Medical Student Association, representing two-thirds of all medical students in the United States. In addition, many members of Congress who have signed onto H.R. 676 spoke, and related stories of their own families' experience with health care.

Both Conyers, who chairs the House Judiciary Committee, and Moore stated from the outset that in addition to the 47 million Americans without health insurance, including 8 million children, another 50 million are under-insured, meaning that they have health insurance, but with inadequate coverage or unaffordable deductibles and co-pays. The Institute of Medicine has estimated that 18,000 Americans die each year as a direct consequence of being uninsured or underinsured. Both men made the point that this is unacceptable in the richest country in the world, and the horrible consequences were dramatically illustrated in scenes from Moore's film.

H.R. 676 establishes a publicly financed, privately delivered health-care system that improves and expands the already existing Medicare program to all U.S. residents, and all residents living in U.S. territories. The goal is to ensure that all Americans will have access, guaranteed by law, to the highest quality and most effective health-care services, regardless of their employment, income, or health-care status. The bill has been endorsed by the AFL-CIO executive committee, eight international unions, 19 state AFL-CIO affiliates, 14,000 physicians, two State Houses, and dozens of county and municipal governments. As of June 20, the bill had 74 co-sponsors, and Conyers announced during the event, that as a result of

Moore's presence on the Hill, and the movie's pre-screening, many more members had agreed to sign on.

Lyndon LaRouche endorsed H.R. 676, which was first introduced in 2003, on April 10, 2006, when he characterized support for the legislation as a "litmus test" of the morality of members of Congress. In his many statements on the health-care crisis, LaRouche has stressed that not only must the HMO system be abolished, but that there must be a return to the Hill-Burton principle of providing care to all, and building the infrastructure to deliver on that principle. The 1946 Hill-Burton Act—officially titled the "Hospital Survey and Construction Act," launched a Federal-state drive that resulted in a nationwide grid of over 7,000 public hospitals, equitably covering rural and urban populations, in 3,000 counties. But since the 1970s—the peak of the hospital coverage period—this grid has been continuously reduced, as the managed-care/HMO era took over, cutting both infrastructure and care.

Statistics released at the press conference by the California Nurses Association show that the 20 largest HMOs in the United States made \$10.8 billion in profits in 2005. In the course of the event, a number of health-care professionals testified that their jobs required them to figure out every possible way to deny benefits to policy-holders, and that the entire system is based on assuming that care will be denied. Moore presented HMO statistics on what percentage of people will contest unpaid claims, and showed how this is calculated as part of their business plan.

H.R. 676 is unique among all the various health-care reform proposals claiming to provide universal coverage—including those being touted by both Democratic and Republican Presidential candidates—in that it eliminates HMOs and the private insurance industry entirely from the system. The political pressure on the Presidential candidates to provide something other than rhetoric on the health-care issue will be increased as more and more people see the Moore film, and by the fact that Democratic Presidential hopeful Rep. Dennis Kucinich (Ohio) is an original co-sponsor of H.R. 676, and is aggressively promoting it in his campaign for the nomination.

## **National Mobilization Announced**

Conyers announced that the June 20 event would be the kickoff of a national mobilization, including the June 29 opening of "Sicko," in numerous U.S. cities, and the establishment of a national headquarters and a national organization to promote H.R. 676. Conyers also announced that this event marked the first of a series of activities that he will sponsor on America's health-care crisis during the 110th Congress. On July 17, the Judiciary Subcommittee on Commercial and Administrative Law will be holding a hearing on medical debt as a contributor to bankruptcy. Figures released at the event show that half of all personal bankruptcies are caused by illness or medical bills, and that the number of medical bank-

ruptcies has increased by 2,200% since 1981. Conyers has also just put in a request to the Government Accountability Office to further examine the problems with the current system, and a request to the Congressional Budget Office to do a cost estimate for establishing a system of single payer health care.

The three clips from Moore's film were all shocking, even to an audience well-versed in the horrors of the U.S. health-care system, the more so since, in two of the three cases, the individuals involved had health insurance. In the first case, the wife of a 37-year-old African American cancer patient worked at a major hospital, and it was the CEO of the hospital who denied her husband a bone-marrow transplant, arguing that the treatment was experimental, despite submissions from the patient's physician documenting "research-based evidence" of its necessity and efficacy.

In another case, an 18-month-old baby with a 104° fever was taken to the nearest hospital emergency room, but because the mother's Kaiser Permanente plan considered this an out-of-network hospital, the child was not treated, and was transported to another hospital, had a seizure en route, and died. Coincidentally, a June 22 hearing of the House Committee on Oversight and Government Reform, chaired by Rep. Elijah Cummings (D-Md.) reported that the Department of Health and Human Services has ignored over six years of repeated warnings that America's emergency rooms are understaffed, overcrowded, underfunded, and overwhelmed.

But the last film clip was the perhaps the most shocking: It exposed the practice in which California hospitals dump indigent patients out onto the streets of Skid Row in Los Angeles. The hospitals paid the cab fare, took the patients out of their beds, in many cases with the IV still stuck in their arms, and had the cab dump them on the street. Rev. Andy Bales, director of the Union Rescue Mission, reported that he has arranged for video cameras, termed the Hospital Dump Cam, to film patients being dumped onto the street. He has also convinced the Los Angeles Police to make arrests of those responsible for this practice.

Moore demanded that Congress make it a criminal act to dump patients out of hospitals, and said that since letting someone die or causing their death is a crime, people should call 911 and report an attempted murder in process. He reported that the California Legislature was in fact debating a bill that day to make it a crime for hospitals to do this, and the HMOs were lobbying to stop the bill. The City Attorney of Los Angeles has filed criminal charges against some of the city's hospitals.

Moore had sent personal invitations for a free viewing of "Sicko" on the day of the Conyers event to over 900 health-insurance and pharmaceutical lobbyists. According to Moore, there are four health insurance lobbyists for every member of Congress. A total of 11 showed up to view the film in contrast to a later evening showing, where a large number of members of Congress attended.

# International Attacks on BAE: The Real Target Is Cheney

by Nancy Spannaus

A faction fight within the ranks of the British Establishment has broken out into the open over the international scandal over BAE Systems, the British defense firm that has been exposed as the center of an arms-for-oil deal which Lyndon LaRouche has characterized as the “scandal of the century.” The target of the quarrel within British ranks, commented LaRouche on June 28, is U.S. Vice President Dick Cheney, who is in deep trouble with his London friends for being unable to ensure that BAE’s filthy operations—which are estimated to have generated an \$80-100 million slush fund for Anglo-American use—never saw the light of day.

Under the now-departed prime minister Tony Blair, the British government acted decisively to squash the investigation by the Serious Fraud Office (SFO) into BAE bribes to Saudi Prince Bandar bin Sultan. Blair himself declared that the investigation would harm Britain’s “national security,” and British Attorney General Lord Goldsmith closed down the SFO probe in December 2006. News reports at the time of the Cheney visit to Riyadh revealed that Cheney took personal responsibility for shutting down the BAE probe, assuring that the Al-Yamamah project would go forward, scandal-free. According to one account, Cheney contacted Blair, and within a matter of weeks, Lord Goldsmith announced the shutdown. Prince Bandar bin Sultan, the former Saudi Ambassador in Washington and a central player in the entire BAE/Al-Yamamah scandal, also reportedly threatened the Blair government with a cutoff of Saudi cooperation in the war on terror, and this was a further factor contributing to the bungled coverup.

But action in early June by certain British factions to reopen the probe, and, most decisively, the spotlight put on the strategic significance of BAE’s Al-Yamamah deal as the biggest scandal in 100 years, by the LaRouche movement, has shot to hell the attempt to suppress it. A major investigation of BAE’s crimes is now underway by the U.S. Justice Depart-

ment (see *National*), as well as in other nations. Try as they might, the British royals are not going to be able to protect this Crown Jewel.

In fact, U.S. intelligence sources are already tracking the activities of Blair, who, they report, is quietly attempting to create a network of “charitable” organizations, which could be used to house some of the formerly BAE-managed dirty operations. These sources cite Blair’s recent pilgrimage to the Vatican, where he had an audience with Pope Benedict XVI, and announced his conversion to Catholicism. Blair, the sources say, has also been badly scarred by both the recent Scottish elections, in which the Labour Party lost its majority to a pro-separatist Scottish National Party (SNP), and by the backfire effect of his December 2006 clumsy effort to bury the BAE scandal. That Goldsmith-Blair effort was so poorly executed that there are now nearly a dozen separate investigations of BAE going on around the world—including the recently announced U.S. Department of Justice probe and the prospect of the BAE dealings with Prince Bandar being taken up by oversight committees of the U.S. Congress.

## ‘The U.S. Is Not a British Colony’

On June 28, LaRouche warned those forces in the United Kingdom who are thinking about stopping the U.S. investigation into the bribery practices and other crimes of the defense giant BAE, to remember that the U.S.A. is a sovereign nation, and this investigation is in the national security interests of the United States.

“Some people in London may not understand that, contrary to what appear to be their persisting wishes, the United States is not a British colony. That ended with the Declaration of Independence in 1776.”

“The point is, the U.S. government is sovereign and has a right to conduct a full investigation,” LaRouche said. “Some

people in London may not yet understand that the United States became sovereign with its Declaration of Independence, and remains sovereign despite some irregularities betwixt and between. And thus, if the charges against BAE concern an international affair that rightly affects the interests of the United States, the United States has a perfect sovereign right to investigate, or challenge this.”

LaRouche cautioned that, “maybe the continued existence or fall of the newly constituted [Gordon] Brown government may depend upon his rising to the occasion on this one. Maybe the rise or fall of the Brown government may depend upon his coming to his senses on this matter.”

### **Which Way Will the British Go?**

As Gordon Brown moves into the Prime Minister’s office, the faction fight within the British ranks over BAE is raging.

Taking the side of pursuing the BAE matter by, among other things, providing assistance to the U.S. Justice Department investigation, is the *Financial Times*, which penned a scathing second editorial on June 28. Since the U.S. press persists in refusing to cover the scandal beyond the most meager headlines, we provide substantial quotes from the editorial statement, which was titled, “Shaming Britain: Department of Justice is right to investigate BAE Systems”:

“The US Department of Justice has decided to launch its own probe into whether BAE systems, the British defence contractor that is also a large supplier to the Pentagon, has violated the Foreign Corrupt Practices Act. That decision shows the UK government’s arguments for suspending its investigation—that it would wreck a vital national security relationship with the Saudis and cost thousands of jobs—for what they are: specious realpolitik and economic excuses. . . .

“Allegations of bribery should be investigated: the law is the law. There are many in Saudi Arabia who want more transparency and the Saudis were never likely to cut off cooperation on national security matters. Britain might lose future arms sales if wrongdoing is exposed, but ignoring the law for the sake of economic expedience is an action of the mercenary and the cynical.

“Those in the Saudi government who put pressure on Britain to abandon the probe have served their country poorly. They have turned a UK investigation into a U.S. inquiry and thrust Al-Yamamah into the international spotlight. . . .” Gordon Brown should order cooperation with the DoJ probe for “redemption.”

### **Dragging Their Feet**

A rather different tone was taken by the London *Times* in its story on June 28. The story claimed that the British government is “scrambling . . . to find out how wide and deep” the DoJ investigation into BAE will be, and that the government is anxiously awaiting information on how extensive and embarrassing the investigation might be.

The London *Independent*, on June 27, wrote that the Brit-

ish government and BAE would have been better off keeping the investigation in London, because now, “being immersed in the icy waters of the Justice Department,” there’s no telling what will happen, penalties are likely to be harsher, etc. “BAE Systems hoped to bury the past. Instead, there now appears to be no stopping it being exhumed. With so much to lose in the US, BAE has no option but to co-operate fully.”

But the *Daily Telegraph* of June 29 didn’t leave any question as to where its faction of the British Establishment stands. “BAE is none of Washington’s business,” trumpeted a signed column. Con Coughlin, a senior writer for the *Telegraph* (also known as the *Torygraph*, because of its role as a mouthpiece for the Conservative Party), reflects the anger of certain circles in Britain who are not amused by the fact that BAE is under criminal investigation by the U.S. Department of Justice. Coughlin lamely tries to dismiss the investigation as being “motivated by jealousy over the vast profits that BAE and the Government have derived from the initial deal.”

“And there are suspicions,” Coughlin continues, “that the Americans are trying to derail the latest arms agreement between Britain and Saudi Arabia—‘Son of al-Yamamah.’” Coughlin threatens the U.S. that it will be faced with anger and retaliation on the part of the Saudis, and concludes, “Certainly, the attitude of both the British and Saudi governments is that whatever deals they may have done in the past, they are none of Washington’s business.”

But in another article, the *Telegraph* admits that the Ministry of Defence has little choice but to collaborate with the U.S. probe—if Britain wants to maintain any credibility with Washington.

### **Scandal Spreads Worldwide**

There is no unanimity in Saudi Arabia over the BAE revelations either. There is reportedly a split within the Saudi royal family over how to deal with the scandal, now that it has become a legal matter in the United States, and more than a little rage at Cheney, who was unable to protect BAE from criminal investigation.

Nor is Saudi Arabia the only place where BAE’s financial crimes, or worse, have become matters of official concern. *EIR* has uncovered reports of official active probes in at least seven countries in addition to Britain and the United States. They include: Austria, Bulgaria, the Czech Republic, Hungary, Slovakia, Sweden, and Switzerland. Most of the allegations under investigation involve charges of bribery, although illegal arms trafficking has also been suggested.

Much of the investigation has been centered in the Organization for Economic Cooperation and Development (OECD), which has been looking at BAE’s activities for years. Interestingly, the individual who will head the DoJ’s criminal probe into BAE, Mark Mendelsohn, is a career prosecutor, who is the point person at the Justice Department for working with the OECD Bribery Task Force.

# John Bredenkamp Puts His Foot in It

by the Editors of EIR

---

We publish—and then comment on—the attached letter by John Bredenkamp, a South Africa-born businessman who has been at the center of a large number of arms trafficking controversies over the past several decades.

---

Breco and Masters Group of Companies  
From the Chairman's office—John A. Bredenkamp  
28 June 2007

Dear Mr Steinberg,

In your article “Will BAE Scandal of Century Bring Down Dick Cheney?” (EIR Volume 34, Number 26, June 29, 2007), you make a number of untrue, incorrect and defamatory allegations about me, which are manifestly malicious.

- You state that I am ‘*a major arms broker throughout Africa*,’ This is a wholly erroneous and extremely damaging allegation. I have repeatedly stated that my involvement in the defence sector is that of a passive investor in Aviation Consultancy Services, a company that represents a number of leading aircraft manufacturers, both civil and military. A simple Google search on the internet would have led you to my website where you would have found this information.

- You say that ‘*U.S. intelligence sources have identified (me) as a conduit for Soviet arms to African insurgents*,’ This is an extremely serious allegation and utterly without foundation. I have never supplied arms to ‘African insurgents’. I can only assume you have made this up to further your own sensationalist agenda.

- You then go on to speculate that this identification raises “*questions about his (my) earlier involvement with the Al-Yamamah project*”. This is totally without foundation. I have never had any involvement in the Al-Yamamah project. Such a fictitious reference must clearly be designed as a deliberate and malevolent slur.

- I am indeed cooperating with the UK's Serious Fraud Office in their investigation re allegations about BAE sales to South Africa. As a non-UK resident, I voluntarily flew to the UK late last year to offer them my assistance.

If you had bothered to check my website—www.breco.info—you would have found the correct information and also would have had the opportunity to contact

my Press Office by e-mail. Instead, you have misrepresented me in a highly damaging, irresponsible and offensive manner. . . .

Regards,  
John Bredenkamp

PS—It could also [be] construed by anyone who reads your article that the source of your allegations about me could be Mr William Simpson. To that end, I am copying this letter to him and his publishers, Harper Collins.

\* \* \*

In describing the “charmed life” of John Arnold Bredenkamp, consistently described as an “arms broker,” “arms dealer,” “arms merchant,” “weapons dealer,” “weapons broker,” we must proceed from the reality of the circumstances under which Bredenkamp has operated since no later than the mid-1980s. He dwells in a no-man's land in which a man's hand pleads innocence of the actions conducted by his foot; a world in which the hand which loads the sniper's rifle denies any culpability for the eye which aims at the target, or the finger which pulls the trigger. In brief, he dwells in the same clock-work-orange world he shares with BAE.

Therefore, in describing the “charmed life” of John Arnold Bredenkamp, it is difficult to know where to start. In fact, it is difficult to find a media reference to him that *does not* mention his business in arms trafficking. From the notoriously unreliable, LaRouche-hating Wikipedia, to the London *Observer*, to the *Washington Times*, to the *Guardian* of the U.K., to WorldNet Daily, to the UN Association of the United Kingdom, to a broad swath of British-based organizations and NGOs that specialize in opposing arms proliferation, Bredenkamp is repeatedly mentioned in the context of arms trafficking—selling, brokering, and violating sanctions.

The first case always brought up is Rhodesia. When Zimbabwe was Britain's all-white-run racist colony known as Rhodesia, and Ian Smith declared its independence, as an all-white racist state, John Arnold Bredenkamp gained the reputation as a “sanctions buster” supporting the racist Smith regime. Many years later, in 2001, Bredenkamp was again charged with violating international sanctions—this time, the unjust, politically driven sanctions against Zimbabwe.

Bredenkamp describes himself this way: “Like many of my contemporaries, I have adapted to change. I was Rhodesian; I am now a Zimbabwean. I was a tobacco merchant; I am now an investor in many different sectors.” When the George W. Bush regime imposed sanctions against Zimbabwe and its President Robert Mugabe, Bredenkamp was reported to be among Zimbabwe businessmen put on the U.S. sanctions list. He denies violating the sanctions against Zimbabwe, and moaned that, “The U.S. State Department has tried me and judged me in a manner which affects my fundamental rights as an individual. . . . I have been given no opportunity to be heard in this matter.”<sup>1</sup>

There have been detailed documentaries by European TV companies that provide colorful descriptions of Bredenkamp’s arms trafficking. Sweden’s Uppdrag Granskning TV show, which aired this year, suggested that Bredenkamp should be investigated in the BAE bribery scandal in South Africa. A British TV documentary, aired in 1994, called “The Casalee File,” contains detailed allegations about Bredenkamp and the arms trade.

The website of the British Film Institute—created by Royal Charter in 1983—describes “The Casalee File” as follows: “Exposé of a major Berkshire based tobacco company, The Casalee Group, now called Defco, which has been secretly at the heart of the arms trade and breached international sanctions in many of the deals it has done. Mines sold to Iraq killed and maimed British soldiers in the Gulf war. Owner John Arnold Bredenkamp has supplied arms to Rhodesia, Iran and Iraq. Contributors include wounded soldiers; former Casalee manager Mike Pelham; former directors of arms manufacturers ASTRA; a defence analyst; Congressman Henry Gonzalez.”

In the documentary, Mike Pelham, former financial officer of Casalee Zurich, which is one of the offices of Bredenkamp’s Casalee Tobacco company, said: “The objective was to arrange an introduction between a supplier to a purchaser. Casalee would do that. The arms would then be transferred from the manufacturer directly to the purchaser and on the deal having been finalized then a commission would be paid from the manufacturer to the agent, in this case Casalee.”

Pelham discusses Casalee’s involvement in the sale of anti-aircraft guns to Iran by Oelikon Burhle, a Swiss arms manufacturer: “The amount sold into Iran would run into the hundreds of millions of dollars. The commission . . . would be 5% on an excess of 100 to 200 millions. . . . Every deal that went through had to have a bribe of some sort attached to it. The money would be paid to Casalee, and then Casalee would make the necessary payments to those people of influence in the purchasing country. For the manufac-

turer to make those payments it would become a little dicey. For an intermediary like Casalee or other companies of that nature to make the payment is not at all difficult. On the manufacturer’s books all you would get is that a commission would have been made to an agent, Casalee, and an investigation would not be made into Casalee’s books after a disposal of the funds.”

“Oelikon did not do the deal with Casalee,” Pelham adds. “The deal was done with a company called Vivian Corporation. . . . It is preferable to, on deals like this, to take them away from the main company. A big deal like this involving many millions should be isolated. It becomes more difficult to trace, more difficult to connect to Casalee. The offices concerned would be a lawyer. To Casalee, any subsequent tracing of Vivian would not show Mr. Bredenkamp.”

The payments, Pelham said, would be made “only in cash. There would have been no trace. . . . Corruption is the name of the game in the arms business. Yes in this particular scene it was a little worse than usual.”

Pelham adds, “Mr. Bredenkamp stated he would not deal or would not allow dealings to take place with Libya. He also refused to become involved in transactions with irregular groups, the Irish Republican Army, the IRA, he would not supply arms to.”

Any communications by Mr. Bredenkamp about Mike Pelham’s statements could not be located.

## Spooks Speak

In the murky world of intelligence agencies, Bredenkamp also has a record in the media. A former MI-6 intelligence agent, Tracey Kinchen, spoke to WorldNet Daily about arms trafficking and MI6. “In the past, we worked with some of Bredenkamp’s satellite companies—like Casalee, Zimalzam, Breco Services, Masters International—in several of our former colonies. One minute, MI-6 . . . was on the side of the anti-communists in places like Rhodesia, Hong Kong, Tibet, Nepal and Cambodia. Then, suddenly, we were told to change sides.”<sup>2</sup>

On Feb. 18, 2000, *Washington Times* reporters Bill Gertz and Rowan Scarborough wrote that the U.S. Defense Intelligence Agency (DIA) wrote a classified report for Secretary of Defense William Cohen about secret arms shipments to the Democratic Republic of the Congo (D.R.C.). The reporters say that the D.R.C. and Zimbabwe were purchasing arms from Bredenkamp, whom they identify as an arms dealer based in Belgium.

## A Leg To Stand On?

Mr. Bredenkamp’s letter provides no substantial facts refuting the matters raised in the cited *EIR* article.

1. Statement to the International Consortium of Investigative Journalists, by Mungo Soggot and Phillip van Niekerk, Nov. 11, 2002.

2. Anthony LoBaido, “Surviving Mugabe’s communist reign,” WorldNet Daily, Dec. 10, 2000.



An Oct. 16, 2002 report to the United Nations Security Council by a panel of experts investigating the exploitation of raw materials in the D.R.C. cited Bredenkamp's role as an arms broker:

"John Bredenkamp, who has a history of clandestine military procurement, has an investment in Aviation Consultancy Services Company (ACS). The Panel has confirmed, independently of Mr. Bredenkamp, that this company represents British Aerospace, Dornier of France and Agusta of Italy in Africa. Far from being a passive investor in ACS as Tremalt representatives claimed, Mr. Bredenkamp actively seeks business using high-level political contacts. In discussions with senior officials he has offered to mediate sales of British Aerospace military equipment to the Democratic Republic of the Congo. Mr. Bredenkamp's representatives claimed that his companies observed European Union sanctions on Zimbabwe, but British Aerospace spare parts for ZDF Hawk jets were supplied early in 2002 in breach of those sanctions. Mr. Bredenkamp also controls Raceview Enterprises, which supplies logistics to ZDF. The Panel has obtained copies of Raceview invoices to ZDF dated 6 July 2001 for deliveries worth \$3.5 million of camouflage cloth, batteries, fuels and lubricating oil, boots and rations. It also has copies of invoices

for aircraft spares for the Air Force of Zimbabwe worth another \$3 million."

Bredenkamp protested the findings of the UN panel and, along with others, brought pressure on the UN to change its findings. One year later, the same UN panel released a follow-up report which categorized the case of Bredenkamp as "resolved subject to NCP monitoring compliance." However, this second report was very general and contained no specific refutation of the same panel's earlier findings. Bredenkamp's Breco Company's press release praising the second UN report was equally vague, and also failed to specifically address the findings of the first UN panel with respect to the arms dealing activities of Bredenkamp's companies.

Bredenkamp has also been implicated in the BAE scandal. In October 2006, his home and office in England were raided by a joint force of the Serious Fraud Office (SFO) and the Ministry of Defence, which was reportedly looking into allegations of bribery in connection with BAE arms sales to South Africa. The SFO said the raids were "part of an ongoing investigation by the Serious Fraud Office and defence ministry police into suspected corruption relating to defence contracts where BAE Systems is the prime contractor," as reported by *Business Day* of Zimbabwe in November 2006.

# KNOW YOUR HISTORY!

## *The American System of Political Economy*

**The Civil War and the American System: America's Battle with Britain, 1860-1876**

ed. by  
W. Allen Salisbury  
\$15.00

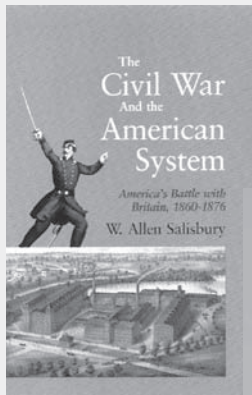

ORDER TODAY!

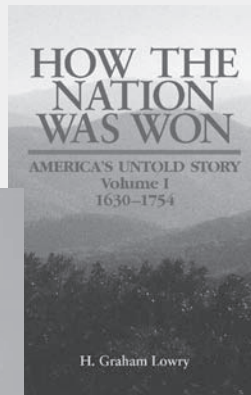

**How the Nation Was Won: America's Untold Story**

Volume I, 1630-1754  
H. Graham Lowry  
\$19.95

*Bridge Across Jordan*



Amelia Platts Boynton Robinson

**Bridge Across Jordan**

by Amelia Platts Boynton Robinson  
\$10.00

ORDER FROM

**EIR News Service, Inc.**

P.O. Box 17390

Washington, D.C. 20041-0390

Order by phone: **1-800-278-3135** (toll free)

**OR** order online at **www.larouchepub.com**

Shipping and handling: Add \$4 for the first book and \$1.00 for each additional book. Virginia residents add 4.5% sales tax. We accept MasterCard and Visa.

## German Chairmanship Missed Crucial Issues

by Rainer Apel

If one needed more proof that Europe is virtually ungovernable, the just-concluded German presidency of the European Union during the first six months of this year provides ample evidence. Along with a good part of the German elites, Chancellor Angela Merkel decided not to take any notice of the changed situation after the U.S. midterm elections in November 2006, but to conduct her half-year presidency as if the neo-con agenda were still unshattered, and the elections had never taken place.

This implied going ahead with the ill-advised project of a “trans-Atlantic free trade area,” with an anti-Putin policy, by putting “emphasis on human rights and democracy in Russia,” with continued loyalty to the supra-nationalist Maastricht Treaty straitjacket of European budgetary austerity, and, worst of all, with the idea of rescuing and reviving core aspects of the very draft for a European Charter, which was already rejected in referenda in France and the Netherlands in 2005. The Charter as such is dead, because after two member states of the EU rejected it, it cannot be implemented.

The Merkel trick is to present some of the aspects of the Charter draft again, under the new name of the “European Treaty.” Since the voters already rejected the first draft, Merkel is opting for a formula that would be supported by the governments only, without the need for ratification by parliaments, or citizens in public referenda. Merkel was encouraged in this gambit by the just-resigned Prime Minister Tony Blair. There is a British hand in the uproar which this approach by Merkel provoked, especially in Europe’s eastern states.

The fear of the large state of Germany by the smaller states of eastern Europe, has been effectively played upon, by using a favorite British black propaganda tool against Germany, which is the charge that the reunified Germany is too powerful in Europe, and that it is on its way to becoming a “Fourth Reich.” This phony confrontation worked especially well with the extreme nationalists of Poland, who now form the government there.

The real issue here is, however, not Germany per se, but German economic relations with Russia, which are considered an obstacle to globalization by the ruling financial circles in London. And ironically, Merkel made herself spokeswoman for Polish complaints against Russia, at the recent EU-Russia summit, to an extent that, along with her polemics

against the alleged “suppression of human rights in Russia,” she risked a breakup of the summit. Yet, her service to the “Polish cause,” failed to earn her any favors from Polish nationalists, who fiercely attacked her at the June EU summit in Brussels.

That German-Polish struggle dominated the public debate and media coverage, before and during the EU summit, and because of that, not much attention was paid to the fact that some other things occurred at the EU, during that time period: With the 27 EU leaders approving the script for new voting rules in the community, the synarchist faction in the financial oligarchy moved one big step ahead in European affairs with their plan of world dictatorship.

The formula agreed to at Brussels abolishes the veto power of member-states, the last institutional resource of sovereign resistance against the policies of the European Commission bureaucracy; instead, a new “qualified majority” is to be implemented, which implies that once 55% of the EU’s member-states, or 65% of the total EU population, agree on a particular policy, it cannot be vetoed. This is one of the core components of the very European Charter that was rejected by the Netherlands and France in the Spring of 2005.

Another core component of the old draft, the establishment of a common high representative of the European Union, was agreed to at the Brussels summit as well, and it has not come as a surprise to insiders that none other than the newly unemployed Tony Blair has received strong backing from European leaders to be the first politician occupying that new post, effectively a kind of European prime minister, appointed by the EU Council of Ministers. This would amount to another big erosion of the sovereign rights of the European electorates. The new scheme will provoke new resistance throughout the European Union, thereby making Europe and its national governments even more ungovernable.

What the German presidency of the EU should have achieved, would have been a European initiative for the convening of an international government conference on the urgency of a reform of the global monetary-financial system. The weight of Germany as the biggest economic power in Europe could have been utilized, to get such an initiative going, and it would have had its maximum constructive impact, if coupled with a thrust for increased East-West cooperation along the lines of the proposals made by Lyndon LaRouche for the development of the Eurasian Land-Bridge, in close cooperation with Russia. That would have provided a grand design for EU policies, in which also the nations of Europe’s East, including Poland, could have defined a specific constructive role of their own in the framework of a greater mission.

Merkel, whose favorite slogan is “the policy of the many small steps,” has proven incapable of any such grand design; moreover, she has preferred confrontation with Russia, and with that, she missed a big chance for Europe, during her tenure as EU president.

---

## Book Review

---

# Roosevelt-Stalin Correspondence Sheds Light on FDR Post-War Vision

by William Jones

---

### **My Dear Mr. Stalin: The Complete Correspondence of Franklin D. Roosevelt and Joseph V. Stalin**

Susan Butler, ed; with a Foreword by Arthur Schlesinger, Jr.  
New Haven: Yale University Press, 2005  
361 pages, hardcover, \$35

---

The publication for the first time of the complete correspondence between Franklin Roosevelt and Joseph Stalin provides an important insight into Roosevelt's wartime shaping of his personal relationship with the Soviet leader. While plotting the course of victory over the Axis powers, Roosevelt always kept in view the process of creating the basis for a stable post-war system that might eliminate war. While the correspondence does not provide a comprehensive picture of Roosevelt's "world blueprint" for the post-war world, as journalist Forrest Davis dubbed it, it clearly indicates the direction in which Roosevelt was moving, and underlines the absolute importance he attributed to the participation of the Soviet Union in that plan. Davis, often used to "float" ideas that Roosevelt wanted to get into circulation, had interviewed FDR shortly after the Tehran meeting, and, in a series of articles printed in the *Saturday Evening Post* in May 1944, tried to give an outline to Roosevelt's vision of the post-war world. An understanding of the significance of the issues touched upon in their correspondence is brought into focus by the book's editor, Susan Butler, whose introduction and introductory comments to many of the letters supply the broader context in which the discussion is conducted. The book is appropriately dedicated "to the 405,000 Americans and the 27 million Rus-

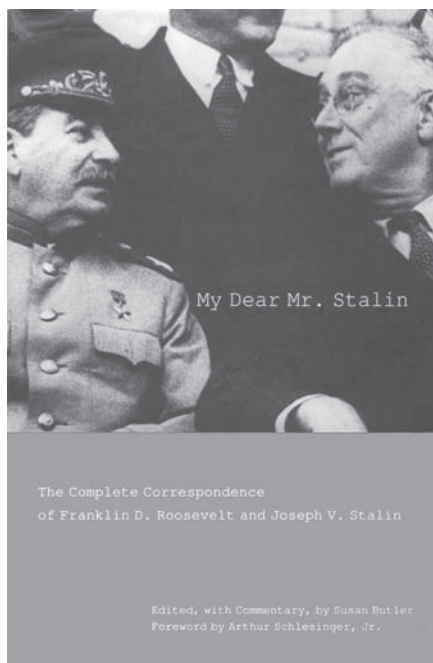

sians who died in World War II."

The correspondence also reveals the serious differences that President Roosevelt had with wartime "ally" Winston Churchill, over the course of the war, and, more fundamentally, over the shape of the world that would emerge from it. Roosevelt was intent on reshaping the post-war world around the creation of new nation-states in the developing world that would emerge from the destruction of the old colonial empires, a system which Roosevelt felt had given rise to the war. In that respect, Roosevelt felt that Stalin might serve as a key ally in his attempt to rid the world of the last vestiges of colonialism, and could well serve as a counterweight to the British Prime Minister, who was intent on reviving in some form a post-war British Empire. The correspondence helps also to dispel some widespread myths about Roosevelt's wartime leadership.

### **Bearing the Brunt of the Nazi Assault**

Germany's attack on a totally unprepared Soviet Union in June 1941 meant that the might of that great nation, spanning six time zones, would be pitted against the Nazi behemoth. If it could hold out, victory might yet be had. For this reason, Roosevelt was intent on giving the Soviets whatever they needed to fight. And fight they did.

Writing to Wayne Coy, one of the administrators in Washington, on Aug. 2, 1941, Roosevelt expressed his frustration with the slowness in the deployment of matériel to Russia. "I raised the point in Cabinet on Friday that nearly six weeks have elapsed since the Russian War began and that we have done practically nothing to get any of the materials they asked for on their actual way to delivery in Siberia. Frankly, if I were a Russian I would feel that I had been given the run-around in the United States. Please get

out the list and please, with my full authority, use a heavy hand; act as a burr under the saddle and get things moving. . . . Step on it!"

Not everybody in the administration was happy about this new relationship with the Soviet Union. Both in the War Department and in the State Department, there were those who wished to sabotage the assistance to Moscow. For this reason, Roosevelt appointed his trusted aide Harry Hopkins as the chief envoy to the Russian leader. In Moscow, Roosevelt also bypassed the normal State Department bureaucracy, and promoted, at Hopkins' insistence, a young lieutenant colonel, Philip Faymonville, who had served from 1932 to 1939 as the military attaché in Moscow. Faymonville was fluent in Russian, and had a great respect for the Soviet Union and had many friends there. He was promoted to brigadier general and put in charge of Lend-Lease shipments.

Again in March 1942, Roosevelt wrote to all U.S. war agencies on the importance of the shipments to Russia, saying he "wished all material promised to the Soviet Union on Protocol to be released for shipping at the earliest possible date regardless of the effect of these shipments on any other part of the war program."

Roosevelt also realized that by sticking to the agreements that had been made, he was building up Stalin's trust in the United States, a factor which he hoped to use when once he could discuss post-war issues with the Soviet leader himself. Writing to Henry Morgenthau in the Spring of 1942, Roosevelt commented that he thought that Stalin was right to be distrustful of Churchill. "Every promise the British have made to the Russians, they have fallen down on . . . the only reason we stand so well is that up to date we have kept our promises."

When Stalin's right-hand man, Foreign Minister Vyacheslav Molotov, was to make his first visit to Washington in May 1942, Roosevelt was elated. "Molotov can stay with me in the White House while he is in Washington, but we can make a private home nearby available if that is desired," Roosevelt wrote Stalin. Molotov stayed at the White House for the first days of his visit, and only moved across the street to Blair House when Roosevelt left for Hyde Park.

The role of the British Prime Minister did, however, seriously imperil the confidence that Roosevelt was trying to build between himself and the Soviet leader. In particular, Churchill's squelching of the early plans for beginning an Allied invasion of Europe, which the U.S. military leaders had been prepared to undertake already in 1942, tended to sour the relationship with the Soviet leader. In spite of agreements made with Molotov on his visit, Roosevelt was forced to accede to the diversionary operation in North Africa and later in Italy, that Churchill insisted upon.

The British Prime Minister also had his eye on the post-war world, and he was preparing to restore the power of the

British Empire in one form or another. And, as soon would be apparent, he was also angling to cut a back-room deal, without Roosevelt's knowledge, with the Soviet leader on the division of post-war "spheres of influence." When Churchill again tried to divert Allied forces into an invasion of the Balkans, hoping to further delay the launching of a second front, Roosevelt put his foot down.

### **Building a Four-Power Agreement**

When Soviet troops turned the tide at Stalingrad in February 1943, Roosevelt sent a congratulatory telegram to Stalin: "The one hundred and sixty-two days of epic battle for the city which has for ever honored your name and the decisive result which all Americans are celebrating today will remain one of the proudest chapters in this war of the peoples united against Nazism and its emulators," Roosevelt wrote.

Roosevelt was eager to meet personally with Stalin as soon as possible in order to begin more detailed discussions about the war strategy and the shape of the post-war world. Stalin, who had a fear of flying, was, however, not eager to leave the Soviet Union during the war. Roosevelt also had to maintain direct contact with Washington in order to deal with any upcoming legislation. So, Roosevelt sent his personal envoy, Joseph Davies, the former ambassador to the Soviet Union, to discuss with Stalin the possibilities and venue of such a meeting. In what was certainly more than simply a symbolic measure, on the very day that Davies arrived in Moscow, Stalin dissolved the Comintern, the international Communist organization established after the Bolshevik Revolution, to foment revolution around the world. Roosevelt was "gratified" when he heard the news, hoping that this represented a change in policy by Stalin. The American President was in fact proposing to meet with Stalin separately, before any joint meeting of the three Allied leaders. Stalin wondered why Churchill was not being included in their initial meeting. Davies explained the differences between Roosevelt and Churchill over the colonial issue, and felt that the two of them would understand each other better in that respect.

The first meeting of the three leaders was in November 1943, in Tehran. Churchill tried to arrange a meeting with FDR before Roosevelt met with Stalin, but the President declined, fearful that the Soviet leader would feel that he and Churchill were conspiring against him. In fact, Roosevelt had finagled his way into getting an invitation to stay at the Soviet Embassy, where he knew he would be able to enter more freely into discussions with Stalin. In one of their tête-à-têtes in Tehran, the two agreed that Indochina should not be restored to French colonial rule, Roosevelt commenting that the country was now in worse condition than when the French arrived.

Roosevelt also cautioned Stalin privately not to bring up the question of India with Churchill. Roosevelt was trying to



National Archives

*Truman, under Churchill's influence, rejected Roosevelt's post-war "blueprint" to eliminate colonialism, in favor of Third World development, and to include the Soviet Union in that process. The two are shown here at the Potsdam conference, July 1945.*

bring Indian independence leader Mohandas K. Gandhi into an alliance against the Japanese in return for support for India's independence. Churchill was doing everything in his power to prevent that, making it impossible for U.S. diplomats to even speak with the Indian leader. Churchill considered independence for India a "criminally mischievous" proposition. The Indians, he had written, were "a beastly people with a beastly religion." And he was not prepared to allow Roosevelt to interfere with British India. "The concern of the Americans with the strategy of a world war was bringing them into touch with political issues on which they had strong opinions and little experience," Churchill complained. In this project too, Roosevelt probably figured he would have the support of Stalin.

At their second private meeting, Roosevelt presented his concept for a world peacekeeping organization, with the four great powers, the U.S., Great Britain (shorn of its empire), the Soviet Union, and China, as the kernel around which the other nations might gather. He compared this to his creations of the Pan-American Union, which reversed the imperialist policies of his predecessors toward Ibero-America.

## Reviving the War-Torn Economy

The two also discussed the importance of post-war economic cooperation. Russia, which had suffered enormous losses of men and matériel during the war, was eager to secure a major loan for post-war reconstruction. On Feb. 23, 1944, Roosevelt wrote to Stalin about the Bretton Woods conference. "What I am raising here is the question of further steps toward the establishment of United Nations machinery for post-war economic collaboration, which was raised by the Secretary of State at the Moscow meeting and was discussed by you, Prime Minister Churchill, and myself at Teheran. I should appreciate it very much if you would give me your views on the suggestion made by the Secretary of State at Moscow, together with any other thoughts as to the best procedures to be followed in this extremely important matter."

Later, he would encourage Stalin to have Russia play a major role in the International Labor Organization, which Roosevelt hoped to make a linchpin of his post-war policies. When he heard that Russia was not going to send an observer to the ILO conference in Philadelphia, he wrote to Stalin on March 20, 1944: "It is my opinion that the International Labor Organization should be the instrument for the formulation of international policy on matters directly affecting the welfare of labor and for international collaboration in this field. I should like to see it become a body which will also serve as an important organ of the United Nations for discussing economic and social matters relating to labor and an important agency for the consideration of international economic policies which look directly toward improvement in standard of living. It would be unfortunate if both our Governments did not take advantage of the conference in Philadelphia to help our common objectives."

In the meeting of the three, they discussed the long-delayed opening of the Second Front. Stalin agreed to launch a major offensive in tandem with the Normandy invasion by the British and Americans, a promise which he fulfilled to the letter.

As the Russian armies moved forward, the relationship became more difficult. On a visit to Moscow without Roosevelt in October 1944, Churchill tried to cut a deal with Stalin on their respective "spheres of influence" in Eastern Europe. Hearing about this from Averell Harriman, whom Roosevelt had sent to keep an eye on the British leader while in Moscow, he told Harriman to make it clear to Stalin that the U.S. would never accept any such deal that Churchill had proposed.

The subsequent difficulties with Stalin on the Polish situation are well known. But contrary to popular mythology, the next meeting among the three at Yalta did not result in any "sell-out" of Poland. The agreement signed by Stalin, in fact, endorses "the right of all peoples to choose the form of gov-

ernment under which they will live—the restoration of sovereign rights and self-government,” thus setting a standard by which future regimes might be judged. While getting Stalin’s formal agreement on these principles, Roosevelt knew that, at least in the case of Poland, this principle would not be an easy one to implement.

Regarding the issue of Poland’s borders, FDR felt that he had no right to agree to any readjustment, without Senate approval. While agreeing to shift the border of Russia to the West, into Poland, in accordance with the Versailles Peace Treaty’s determination of the Russian-Polish boundary, the so-called Curzon Line, he hesitated in expanding Poland westward, taking a part of Germany, and was hoping to tackle that issue at a later date. The Soviet army was already occupying Poland, and not much could be accomplished without Stalin’s agreement. “It’s the best I can do for Poland at this time,” the President wrote to his chief of staff, William Leahy.

At the same time, Roosevelt knew that the U.S. could provide the economic means for Soviet Russia to quickly recover from the terrible losses of the war—and that that was a valuable asset in dealing with Stalin on all of these problems. Roosevelt was intent on helping Russia rebuild its tattered economy. Stalin had broached the subject with Donald Nelson, the head of the Works Progress Administration (WPA), when he visited Moscow in 1943. Later, Harry Hopkins suggested that a loan be arranged for Russia, since the Lend-Lease requirements only permitted the export of hardware for the military effort. In January 1945, shortly before Yalta, Molotov had made a request for a \$6 billion credit over 30 years, payment to start after nine years, at an interest rate of 2.25%. Roosevelt thought that such a loan would be part of a package of agreements, in which some concessions on the Polish issue might be garnered. Given the difficulties at the time, Roosevelt did not broach the subject at Yalta. With his death, the chances of any aid coming from the United States, on any terms that Moscow might deem acceptable, looked bleak indeed.

At Yalta, Roosevelt succeeded in getting a commitment from Stalin to enter the war against Japan. A treaty of neutrality between the Soviet Union and Japan had held throughout the war, allowing the Soviet armies to concentrate on fighting Hitler and making possible the massive transport of Lend-Lease supplies through the Soviet Far East. With the imminent defeat of Germany, Stalin was prepared to move against Japan. Roosevelt felt that Soviet participation in the Pacific War would also help cement the relations among the Big Four. Soviet operations against Japan would hasten the end, with Japanese troops in Manchuria sure to be quickly overrun by the Soviet armies. The Soviet Navy was already being provided with American-made mine-sweepers and frigates, and Soviet crews were being trained in their operation in Alaska for possible operations against Japan.

## The Cold War Begins

On the day before he died, Roosevelt was busy working to prevent Churchill from undermining the trust he had so carefully tried to cultivate with Stalin. In a telegram to Churchill on April 11, he wrote: “I would minimize the general Soviet problem as much as possible because these problems, in one form or another, seem to arise every day and most of them straighten out as is the case of the Bern meeting”—a suspicion by Moscow that the Allies were trying to cut a separate deal with German forces based in Italy. “We must be firm, however, and our course thus far is correct.”

Stalin was shocked by the death of Roosevelt: When U.S. envoy Averell Harriman arrived in Moscow to see him, Stalin stated, “President Roosevelt has died but his cause must live on. We shall support President Truman with all our forces and all our will.” The Soviet leader also ordered Molotov to attend the founding conference of the United Nation at San Francisco, a move to which he would not commit when Roosevelt first inquired. Later, Stalin would ask that the death of Roosevelt be investigated, since he thought the American leader might have been assassinated.

The rapport that had been established between the two leaders would quickly be aborted by FDR’s successor. In Truman’s first meeting with Molotov at the White House on April 23, the new President gave him a dressing-down over Poland. “I’ve never been talked to like that in my life,” was the stunned Molotov’s comment. According to Charles Bohlen, who served as Truman’s translator, Molotov “turned a little ashy” at Truman’s brusque comments. Even the chilly Harriman was a bit taken aback by Truman’s behavior. Truman, completely rejecting Roosevelt’s “blueprint,” made the fateful, and militarily unnecessary decision to drop the newly developed atomic bomb in an attempt to keep the Soviet Union out of the Pacific War, and to send Moscow a chilling message of the new military power of the United States. The message was clearly received. As Gen. Dwight Eisenhower commented to a friend on a visit to Moscow for the Victory Parade in 1945, as related by Edgar Snow: “Before the atom bomb was used, I would have said yes, I was sure we could keep the peace with Russia. Now I don’t know. I had hoped the bomb wouldn’t figure in this war. Until now I would have said that we three, Britain with her mighty fleet, America with the strongest air force, and Russia with the strongest land force on the continent, we three could have guaranteed the peace of the world for a long, long time to come. But now, I don’t know. People are frightened and disturbed all over.”

The stage was now set for Churchill’s reemergence after his disastrous electoral defeat, onto the world stage, to launch the Cold War, and to manipulate the Missouri haberdasher now ensconced in the White House, into policies that would thrust the world into two warring camps, living under the threat of nuclear annihilation for the next 50 years.

# Bear Stearns Funds' Failure Opens the Door to Credit Crash

by Richard Freeman

Major sectors of the world financial system were paralyzed by the failure on June 19 of two Bear Stearns hedge funds, linked to the subprime mortgage and Mortgage Backed Securities (MBS) market. The failure has caused the near-freezing up of the highly risky \$2.6 trillion Collateralized Debt Obligations (CDOs) market. By June 28, at least five planned bond or Initial Public Offering (IPO) issuances had been cancelled, and another billion-dollar hedge fund, Caliber Global Investments, had failed because of MBS losses.

The Plunge Protection Committee—officially the President's Working Group on Financial Markets—has worked frantically behind the scenes to try to relieve pressure, first on one crisis, then on another, but the Bear Stearns crisis is merely one part of a shock wave that could overwhelm the world financial system.

Lyndon LaRouche, who described the financial system as nothing but a “gambling system” in his June 21 webcast,<sup>1</sup> commented June 28 on the latest credit market failures of IPOs and funds: “They were having a fantasy; the fantasy turned into a nightmare; they woke up and found out that the nightmare was real. . . . The plain fact is, they're investing in nothing! This is a John Law bubble, and the bubble has reached its end point.”

---

1. LaRouche said: “The great danger of a financial crash today, is that most people, in what they call economics, believe actually not in economics: They believe in gambling. It's called a financial system. It's a gambling system. And . . . ever since Galileo came up with this idea about gambling as the basis of discovering how markets would work, everyone has tried to get a better statistical system for gambling. Like breaking the bank at Monte Carlo, making a killing at Las Vegas, probably one's own. And therefore, these guys who are running the financial world today, depend on the assumption that they've got a 'better system'—as they used to have at the race tracks, a 'better system' for handicapping the horses. And it would really handicap the bettor, in the end, as he found himself on the street without cash—and being pursued by his lenders.”

For the full transcript of the webcast, see *EIR*, June 29, 2007.

## Largest Bail-Out Since LTCM

To recap the way the financial disintegration is spreading: On June 22, Bear Stearns investment bank announced that it intended to bail out two of its failing hedge funds, by extending to them \$1.6-3.2 billion in emergency loans—the latest twist in Wall Street efforts to prevent a full-blown mortgage securities market crisis. The loans have two purposes: first, to prevent the hedge funds' creditors from seizing and selling assets; and second, to prevent the hedge funds' failure from triggering a systemic breakdown of the world financial system.

This constitutes the largest known bail-out since then-Federal Reserve Board chairman Alan Greenspan coordinated a Plunge Protection Committee \$3.6 billion bail-out of the Long Term Capital Management (LTCM) hedge fund in September 1998, on the verge of a general crisis.

The two Bear Stearns hedge funds—the High Grade Structured Credit Enhanced Leverage Fund (HGSCSELF), and the High-Grade Structured Credit Fund (HGSCF)—invested in exotic and insanely risky Collateralized Debt Obligations (CDOs). These CDOs were predominantly invested in MBS bonds, especially those of subprime mortgages. The two hedge funds borrowed what is now reported to be \$9 billion, from the largest commercial and investment banks, including Merrill Lynch, JPMorgan Chase, Citigroup, Deutsche Bank, and Lehman Brothers.

The two hedge funds, predominantly the HGSCSELF, leveraged the \$9 billion in borrowings into \$29.7 billion in gambling bets on CDOs linked to the housing market. But the meltdown of the subprime mortgage market, and the rise of interest rates caused the Bear Stearns funds' bets to go wrong; they have lost billions of dollars, and are going under.

The fly in the ointment, is that the Bear Stearns hedge funds had given the lending banks CDOs as collateral. As the hedge funds' difficulties intensified, on June 19, Lehman Brothers, one of the smaller lenders, seized and sold the col-

lateral—the CDOs—on the market, but received only *50¢ on the dollar*. A big lender, Merrill Lynch, threatened to auction \$825 million of Bear Stearns CDOs that it holds. Reportedly, Merrill Lynch sold \$100 million of the higher quality CDOs. Were Merrill Lynch to have attempted to sell the remaining CDOs on the market, it would have found that they were worth only 30-50¢ on the dollar.

## 50¢ Implications

This is a huge problem. If CDOs were shown in a large sale in the market to be worth half or less of their claimed or rated value, then this would expose the fact that most CDOs, especially those linked to subprime housing, were worth only 50¢ on the dollar. The holders of CDOs would have to devalue their holdings, and not just Bear Stearns, but *all financial firms that hold CDOs*. This would mean the write-down of hundreds of billions of dollars worth of fictitious CDO asset valuation, wiping out overnight the \$2.6 trillion-plus CDO market, one of the fastest-growing parts of the financial bubble.

It appears that deep into the night of June 21, the Plunge Protection Committee and Bear Stearns senior executives hammered out an arrangement, whereby Bear Stearns would provide \$3.2 billion in loans—equivalent to one-quarter of the bank's \$13 billion in capital—to the two hedge funds, and thus to their creditors, rather than allow the creditors to sell CDOs, and rupture the system.

Bear Stearns also did a reorganization of its hedge funds. On June 28, it assigned veteran Thomas Marano, head of the firm's mortgage department, to carry out hedge fund "damage control," according to Reuters. Michael Winchell, another Bear Stearns veteran, was also detailed to that job. But this cleared up nothing.

As the Bear Stearns funds exacerbated the CDO crisis, the \$2.6 trillion CDO market was already like a basement full of gasoline-soaked rags, ready to ignite. While touted as "brilliant creative new instruments," the reality is, they are a form of refuse. Some CDOs are based on faulty mortgage instruments—and they may be the "soundest" of all. Some CDOs are composed of risky highly leveraged loans (called CLOs), used for predatory takeovers. Others, known as "CDOs squared," are CDOs based primarily on other CDO vehicles. Finally, the wildest CDOs, comprising one-third to one-half of the entire CDO market, are "synthetic CDOs," securities based mostly on no assets at all.

In late June, a report assembled by Lombard Street Research, indicated a catastrophe for the vulnerable and heavily pyramided CDOs. The Lombard report read: "Excess liquidity in the global system will be slashed. Banks' capital is about to be decimated, which will require calling in a swathe of loans. This is going to aggravate the U.S. hard landing."

Suddenly, the issuance of new CDOs—and the CDO cancer can survive only if it is growing—began to shrivel up. Ac-

ording to JPMorgan Securities, Inc. on June 28, one month earlier, \$20 billion of new high-grade CDOs were in the pipeline; but that week, only \$3 billion of such CDOs were marketed.

Dan Fuss, vice chairman of Loomis Sayles investment bank, a Boston Brahmin firm, asserted June 26: "If investors start dumping [CDOs], oh boy, watch out for some massive credit widening. This is just the beginning of ugly things to come."

## Liquidity Pullback

The mutually reinforcing MBS and CDO losses exposed in the Bear Stearns hedge fund crisis, spread to other sectors, and produced a dramatic pullback of liquidity in crucial sectors across the United States, Europe, and the world financial system—exactly what the Plunge Protection Committee, headed by Treasury Secretary Hank Paulson and Federal Reserve Board chairman Ben Bernanke, had worked to forestall.

This liquidity pullback has devastating implications for the hedge fund- and private equity fund-driven mergers and acquisitions wave, one of the only things that holds up the bloated world financial bubble. (Last year a record \$4.1 trillion was consummated, and this year the pace was set to exceed that.)

On June 28, the Carlyle Group, the giant buy-out firm, "postponed" the \$415 million IPO that it planned for one of its funds, and reduced it to \$300 million. MISC, the world's largest owner of liquefied natural gas tankers, cancelled a \$750 million bond offering June 27. Foodservice, the American subsidiary of the Dutch supermarket giant Ahold, had to cancel a \$650 million bond offering required by its takeover by KKR. The pall cast over all CDOs—not just those based on mortgages—by the failure of the Bear Stearns funds, had spread over junk bonds and commercial bonds generally.

However, there are further consequences. The failure of CDOs, and the associated credit derivatives, has the potential to rupture the \$750 trillion-plus world derivatives market—a crash which would bring down the world financial system.

LaRouche's June 21 webcast laid out the overall process governing what now is unfolding. This breaking news adds urgency for adoption of LaRouche's proposals for capital-budget initiatives and infrastructure great projects by the United States, Russia, China, and India—his "four-power" solution to the debt crisis.

To reach us on the Web:  
[www.larouchepub.com](http://www.larouchepub.com)



# New Pension Crisis Seen In Credit Markets Crash

by Paul Gallagher

The International Trade Union Confederation (ITUC) released a report June 22 to its members in 153 countries, urging them to pull their pension funds' investments out of hedge funds and private equity funds. The ITUC, with many examples, showed that pension funds' returns from investing in these locust funds have done no better, or lagged behind, ordinary stock market investments: in the case of private-equity-fund investments, for nearly a decade; and in the case of investment in hedge funds, since 2005. It also warned that private-equity takeovers—heavily using pension funds' invested assets—have been shrinking the stock markets for public stocks into which pension funds have traditionally been invested; that they pit older workers' interests against those of younger workers in the pension plans; and that the debt bubbles these funds are building up, are threatening a collapse of financial markets “as soon as credit conditions change.”

Credit conditions are now rapidly changing for the worse (see p. 62), and pension funds—with between 3% and 5% of their investments in hedge funds alone, depending on the report—are directly in the path of disaster. In the past two years, many public pension funds in the United States have added to their hedge-fund investments, their own direct purchase of the super-risky mortgage-backed securities (MBS) and their derivative collateralized debt obligations (CDOs) with which hedge funds and investment banks play. Analysts at real estate investment trusts and banks, warn *EIR* that the huge losses seen coming in these housing-bubble securities (losses in the hundreds of billions of dollars) are going to create a second-wave pension crisis in the United States.

The first wave was low returns and corporate cutbacks of pension contributions from the 1997-98 financial crises through 2005, worsened by Fed chairman Alan Greenspan's drastic lowering of interest rates. The second wave will be outright losses, stemming from pension funds' efforts to “make up” for the earlier crisis by plunging into hedge funds and private equity funds, looking for high-return “junk” to invest in. From junk, they have progressed to “toxic waste.”

## Project Alpha

It started with the General Motors/UAW pension fund's “Project Alpha,” launched in 2003. That year, GM, behind in

its contributions to the pension fund, floated a large corporate bond issue in order to make an even larger, \$19 billion contribution—planning not to contribute again until 2011, and initiating a “secret” investment strategy managed by a team at Goldman Sachs, which other pension managers soon concluded was putting the GM investments into hedge funds. “Alpha” is the Wall Street term for above-average returns—exactly what the ITUC study, and an in-depth earlier study by MIT and the University of Chicago, concluded you don't get from private-equity funds, and now hedge funds.

By 2007, according to a June 18 report by Greenwich Associates, 25% of all the hyper-leveraged assets managed by large hedge funds (\$1 billion or more) internationally, belong to pension funds and endowments. In addition to that, pension funds provide some 20% of the investments in “hedge funds of funds”—operated by banks, and highly leveraged—which in turn provide another quarter of the investments into hedge funds. So the pension fund/endowment share of hedge funds' assets is really about 30%.

Some 40% of the *new* flow of assets into the hedge funds is currently coming from pensions. And in fact, the overall flow of capital into hedge funds has dropped dramatically at the same time—from \$40 billion each quarter over January-September 2006, to just \$12 billion in fourth quarter 2006, and \$20.7 billion in first quarter 2007. In other words, pension fund money coming in, is allowing “smart” money to get out of the hedge funds. Numerous reports, including a new one from Chicago-based Hedge Fund Research, Inc., have shown “high net-worth individuals” reducing their net hedge fund investments by half, between 2006 and 2007—investing instead into real property and stocks. They now account for only about 20% of the assets of hedge funds, which were supposedly made for them.

Looked at from the other standpoint, the proportion of pension fund investments which are in hedge funds and “hedge funds of funds” has risen to about 3%, according to Greenwich Associates. But among public employees' pension funds in the United States, the portion is higher, between 5% and 6%. The largest of all, the \$245 billion California Public Employees Retirement System (CalPERS), which now has 2% invested in hedge funds, on June 19 raised its hedge-fund investments to 4% and its targetted range to 8%. That's a lot

of pension money to lose.

Yet, the Colorado Public Employees Retirement Association (PERA), which has a pension liabilities deficit to make up, has, since 2004, realized higher returns each year, investing exclusively in conservative public stocks, than has CalPERS with its hedge funds, or GM with its "Project Alpha." And large losses have already begun. The San Diego County Employees Retirement Association invested and lost \$153 million, 3% of its assets, in the large Amaranth Advisors hedge fund, which crashed in October 2006. The San Diego fund was one of seven pension funds hit with Amaranth losses, including those of the state employees of Pennsylvania, New Jersey, and Maryland; city employees' pension funds of Philadelphia and Chicago; and the 3M Corp.

But despite such losses, some of the same public pensions are making or planning bigger plunges into hedge funds. The New Jersey State Employees' plan, in a fit of desperation for "junk"-level returns to make up a large deficit, is investing \$20 billion into hedge funds. Richmond, Virginia's employee pension fund, already 5% invested in hedge funds, is "studying" raising that to 7%. The Pennsylvania state employees' fund increased its hedge-fund level to 4%, after losing \$33 million in the Amaranth collapse. New York City's pension plans, which have never invested in hedge funds, are making plans to do so.

These decisions are being made as the failures of large hedge funds are suddenly proliferating due to the spread of the MBS/CDO contagion from the meltdown of the U.S. housing bubble. Just the past two months have seen the collapse of the two multi-billion-dollar Bear Stearns funds; the shutdown of the billion-dollar Caliber Capital Management fund in London; the shutdown of UBS bank's largest hedge fund with \$130 million losses; and large losses by the big Goldman Sachs "fund of funds" called Global Alpha—to mention only the biggest cases.

## The So-Called Toxic Waste

In the virtual panic ("can't sell 'em") which now has leaped from the U.S. MBS pit and seized the global markets for CDOs and even more exotic derivatives, the talk is all of securitized bets on categories of junk debt called investment grade, mezzanine, subprime, and equity—the last also known on Wall Street as "toxic waste." These bonds have been bought because S&P, Moody's, Fitch, and other ratings agencies rated them, apparently, falsely. A list of U.S. pension funds which have bought the last-to-be-paid "equity" tranches of CDOs includes, according to financial analyst John Mauldin on June 27: "The New Mexico Investment Council (\$222 million, and another authorized \$300 million, for 3% of its total fund); the General Retirement System of Detroit (\$38.8 million); the Teachers Retirement System of Texas (\$62.8 million); CalPERS..." (the amount, not noted by Mauldin, is \$541 million). Over a decade, pension funds and endowments have bought 7% of all the "toxic waste" investment banks and

hedge funds had on offer. Why? Because of promised, very high returns. Some of these subprime-rated tranches paid a huge 10% over the London Interbank Borrowing Rate (LIBOR). Some "equity" portions offered 20% above LIBOR.

Mauldin analyzed one large MBS issue of 2006, typical of those bought by the pension funds' feeding-frenzy for high returns, and found that in May 2007, some 54% of the loans it was based on were more than 60 days delinquent, and 17% of them were already in foreclosure.

*Bloomberg Markets* magazine, in a late June article called "The Rating Charade," traced back one such CDO security, issued in 2000 by Crédit Suisse, and combining primarily MBS into five basic "tranches" of debt. The big three ratings agencies named above rated 95% of the whole CDO, investment grade, triple-A or double-A. And what was the fate of those who bought the CDO tranches in 2000? The AAA and AA tranche buyers, or the insurance they bought, lost 25%; all the rest of the CDO was a complete loss. In total, \$120 million was lost, or 35%, on the entire CDO, which had been issued with a 95% AAA rating.

On June 29, 2007, Bloomberg News reported it had done a broad review of MBS issues of debt based on the U.S. mortgage market, and found that 65% of them needed to be downgraded by the ratings agencies. "Take the 300 bonds that are used in the ABX indexes, the benchmarks for the subprime mortgage debt market," researcher Mark Pittman wrote. "190 fail to meet the credit support standard [the ratings agencies used until 2005], according to data released in May by trustees responsible for funneling interest payments to debt investors. Most of those, representing about \$200 billion, are rated below AAA. Some contain so many defaulted loans, that the credit support is outweighed by potential losses. Fifty of the 60 A-rated bonds fail the criteria, as do 22 of the 60 AA-rated bonds and three of the 60 AAA-rated bonds."

As the credit crunch hitting the worldwide CDO markets intensifies, it will be impossible for many of these "investment assets" of the pension funds to be sold at any price. Hedge funds, as they get into trouble in this crisis, block their investors from withdrawing capital for up to 60-90 days, at which point it has usually been too late, as in the Amaranth, RefCo, and Bear Stearns cases.

This is why inside observers of the mortgage and MBS meltdown, watching it from within financial institutions in New York, London, Boston, etc., warn of a new and much larger pensions crisis. They understand that the waves of MBS and CDO losses, perhaps up to near \$1 trillion, will hit the hedge funds and investment-bank "hedge funds of funds" above all. But they see the hedge funds' managing partners using the Summer and Fall months of the crisis to continue "working themselves out" from these losses, with the foolish assistance of the pension funds that are continuing to "work themselves in." IPOs by private equity funds, and huge funds of pension money into hedge funds, are two aspects of this same process.

# No Technical Limits to Bering Strait Project

by Louis T. Cerny

*These remarks were delivered by Louis T. Cerny, then executive director of the American Railway Engineering Association (AREA), at a meeting on the Bering Strait proposal to build a tunnel across the Project, in Washington, D.C. on June 22, 1992. Cerny was executive director of the AREA from 1979 through 1994. Currently, he is a professional engineer in private consulting practice. The speech remains highly relevant today, as international support grows to implement this great infrastructure project.*

I'll have to admit straight out that when I first heard about this project, I was extremely skeptical, and my initial thoughts were that this was another crack-pot idea. I thought—what a crazy idea to go all the way north to the Bering Strait and then to come back south when we have this wonderful infrastructure already in place called the Pacific Ocean.

If someone would have asked me whether the distance from Acapulco, Mexico to Bombay, India was shorter via an all water route or an all land route using a tunnel under the Bering Strait, it would have seemed obvious that the shortest distance between these two tropical locations would be by water. But in fact no, the land distance via the Bering Strait is shorter than the shortest all-water route between Acapulco, Mexico and Bombay, India. The usual wall maps of the world are based on being correct near the equator, but I found that they greatly exaggerate the distances in the far north.

As you can tell, I could have lost a lot of bets about the geographic relation between cities in Asia and North America before I looked at a polar view of the world. As shown on this slide [Figure 1], a straight line drawn between Chicago and Beijing, China falls north, not south, of the Bering Strait. If the Bering Strait tunnel existed to connect the main continents of the eastern and western hemispheres, a whole bunch of new geographic relationships come into place.

With [Russian President] Boris Yeltsin having been here last week, I know the emphasis at this meeting is properly on the connection between the United States and Russia, of development in Siberia, and of course the tunnel and railway would advantageously accomplish those very worthwhile purposes. In addition to that potential, the geographical relationship I just mentioned means that this route also would provide better connections between North America

and the Orient, a new higher speed route for Pacific Rim freight.

Most of us here are familiar with the double stack trains that carry containers stacked one upon the other. These trains have made huge inroads in the way that goods move between the Orient and the United States. Previously most goods between the Orient and the East Coast moved by ship through the Panama Canal. However, about half the cargo traffic between the Orient and New York now moves across the Pacific by ship, and then by double stack trains from the Pacific Coast of the United States.

A typical present-day cargo shipment from China to North America involves moving the containers by train from points in China to the sea coast, a transfer from railway cars to ocean ships, a trip over the Pacific Ocean, a transfer from the ship to railway double stack trains, on which the cargo is carried to the final destination.

## Advantages of the Bering Strait Tunnel

If the Bering Strait Tunnel and Railway existed, trains could run without change of equipment all the way from the Orient to North America. This would have three advantages over the present method involving ocean transport. First of all it would save two transfers—from land to water, and then from water to land. The railways of China and Korea

## U.S.-Russia Rail Project Can Be Easily Implemented

*In a June 23, 2007 communication, Louis Cerny made the following observations:*

There are three additional ideas that I would add:

First, that the portion of the line in Russia can be initially built to the Russian gauge and later converted to dual gauge by the time the tunnel is complete. This would then allow for use of Russian-North American, internal Russian, and China-North American traffic.

Second, that the tunnel could be also used for trains that carry road vehicles, such as are used in the English Channel tunnel. These trains could run from the end of the paved road network in Alaska to the end of the paved road network in Siberia.

Third, that the construction and maintenance of a railroad on permafrost is nothing new, and there are many proven techniques which can be used, including where permafrost conditions change over time.

The strongest point I want to emphasize is that the project, while a very large project, is clearly possible from an engineering standpoint.

FIGURE 1  
**Most Direct Trajectory From Chicago to Beijing**

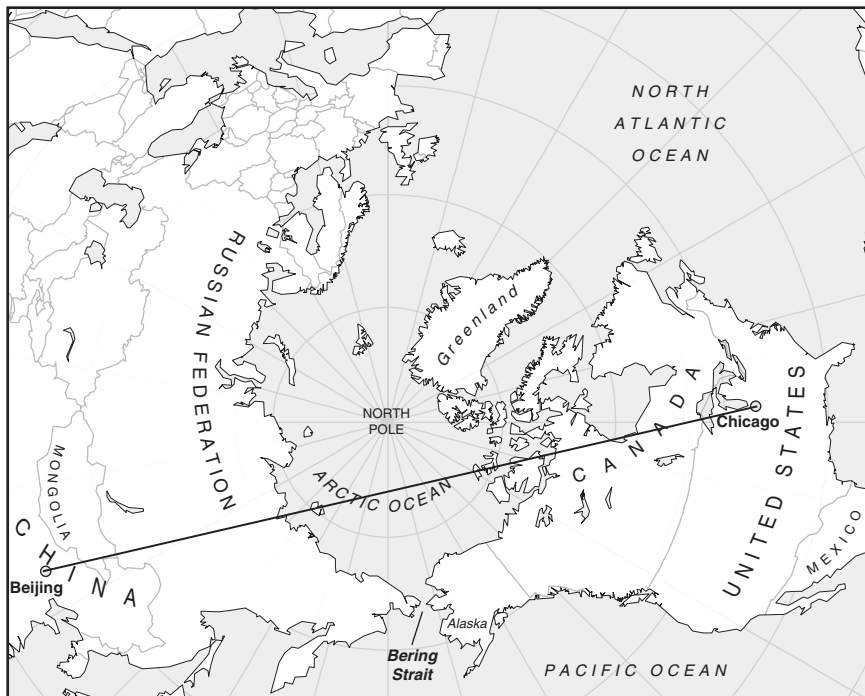

*The shortest distance between Chicago and Beijing actually passes north of the projected Bering Strait tunnel, as this polar-projection map demonstrates.*

are technologically compatible with those in North America. They use the same track gauge (distance between the two rails of the track) and they use compatible couplers and air brakes. Therefore, one set of railway equipment could be used from China all the way to North America thus saving two land-to-water transfers. This is the first major advantage.

The second advantage is that the distance by rail would be shorter than via the Pacific Ocean for the reasons I talked about earlier, when showing the polar map. The third major advantage is that, since this new railway would obviously be built to high standards, the running speeds of the double stack trains typically 55 to 70 miles per hour, are much faster than that of ocean ships.

So with this new railway and tunnel we would have a much improved Pacific Rim cargo service that eliminates two land-water transfers, travels over a shorter route, and runs at a higher speed than the route using boats across the Pacific Ocean. While railways have never before been a competitor in intercontinental freight, the Bering Strait project could change all that and create a better service for cargo around the Pacific Rim than has ever existed previously.

Since Russia's railways are a different gauge, (the distance between the two rails of the track is different) than those in North America, traffic in the main part of Russia would re-

quire a change of equipment.<sup>1</sup> In the case of containers, this involves transferring the container from one train to another, and this one transfer could not be avoided, for traffic that used the existing Russian railway system for part of its journey. However, by making the new railway the same gauge as in North America, all the way to the Chinese border, we do away with any need for transfers for freight moving to and from North America to China and Korea, since the track gauge there is the same as in North America.

The advantage of using the standard gauge to China is that it would provide a seamless access to the vast railway network in China itself. Over 30,000 miles of railway are in the Chinese network; all this track is basically compatible with most North American equipment, and the North American equipment is compatible with Chinese equipment.

The Chinese railway network is still expanding, and has generally been built to high standards. It covers China in a dense network, serving all of the more populated areas of China, along with much of the desert and mountain areas. Most of the lines in China have been constructed in

the last half of the 20th Century, making the age of its railway lines on average, among the newest in the world. While some recently built steam locomotives are still used, the majority of its trains are pulled by modern diesel or electric engines.

The connection of the new Interhemispheric Bering Strait Railway with the Chinese railways would be made in the far northeast of the country, where the Russian Trans-Siberian railway is only a few miles north of the Chinese-Russian border. The link of the new Bering Strait railway with the Trans-Siberian railway would thus only be a short distance from the connection with China. The Chinese network also makes connections with compatible track in Korea. This extensive Chinese network provides a wide spread resource to anchor that end of the railway. The North American railway network, of course, provides extensive coverage of Canada, the United States and Mexico.

### Connection of U.S. and Asian Rail Networks

The new line would connect these two extensive compatible transportation networks so that any point on either rail-

1. The standard railway gauge, which is used in the United States, Europe, and elsewhere, is 4 feet, 8½ inches (1,435 millimeters) between tracks. The broad gauge, which is used in Russia and elsewhere, is 5 feet (1,520 millimeters)—ed.

way network will be accessible to the other without any change of equipment. This could bring the economy of China, Korea, and other parts of the Orient into much closer coordination with that of North America.

That is why it is so important to build the line to standard gauge. If the part in Russia was built to Russia's gauge, one transfer between trains would still be necessary for any traffic from Russia going to North America. But two changes of trains would be required for traffic from the Orient to North America, one at the Alaskan-Russian border and another at the Russian-Chinese border. Obviously, this would badly damage the advantage of through trains handling Pacific Rim traffic, without adding any advantages to Russia-North America traffic, and it would also necessitate a change of trains for traffic from Northeastern Siberia to North America that would not be needed if the entire line is built to standard gauge.

Looking even farther into the future, a tunnel between the Japanese island of Hokkaido and the Russian island of Sakhalin, and a relatively short tunnel of perhaps three or four miles between the island of Sakhalin and the mainland of Asia, could connect the new railroad to the rail network of Japan, where their bullet trains run on the same gauge of track as trains here in the United States.<sup>2</sup> Connections to India and other Asian areas are also possibilities.

The tunnel under the Bering Strait would also allow shuttle trains such as those being built for the tunnel between France and England, to shuttle highway traffic between where the roads end in Alaska and where they begin in Russia, thus giving motorists from North America access with their vehicles to all of Asia, Europe, and Africa, and vice versa.

### Project Is Eminently Feasible

One of the things that is impressive about the feasibility of this project is that it does not involve any unprecedented accomplishments. We are not talking about a project like getting

2. On May 17, 2007, Vladimir Klimenko, head of the state-run Russian Railroads department for liaison with federal and regional authorities, announced that Japan is ready to invest about 300 billion rubles (some \$12 billion) to construct a railroad link between Hokkaido, Japan's northernmost island, and the Russian island of Sakhalin. The islands would be connected through a tunnel underneath the La Perouse Strait—ed.

FIGURE 2  
Future Global Rail Connections, as Seen From North Pole

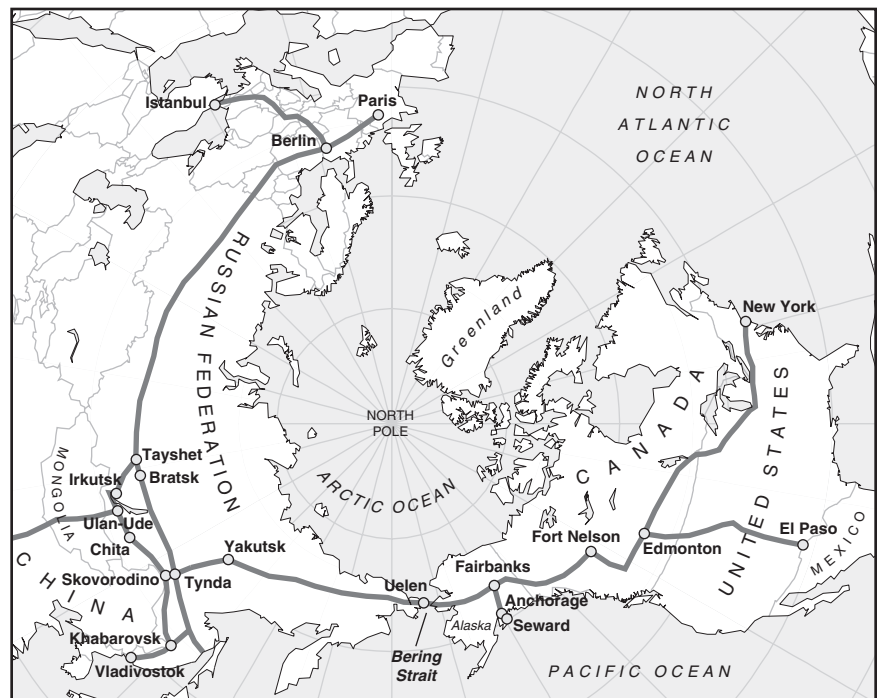

Redrawn from H.A. Cooper

*This plan for extending the Eurasian Land-Bridge across the Bering Strait and into the Americas has long been supported by EIR.*

a person to the moon, which had never been done before. It is simply a large quantity of types of work that have been done before, at other places. The railway itself involves no special new technology, and the railway construction presents no unusual difficulties. The project would involve about 4,500 miles of track, which is less than three times the length of the Transcontinental Railroad which was completed across the United States in 1869 with the famous golden spike ceremony. Certainly now, 123 years later, it would be possible to build a railway more than twice this length. There are already modern railways north of the Arctic Circle that have functioned for many years in reliable heavy-duty service, and this rail line would not even need to be north of the Arctic Circle at any point. The entire line would have daylight at least part of every day of the year.

The line would also connect the presently isolated Alaska Railroad with the contiguous North American Railway network.<sup>3</sup>

Because of the location of the two islands between Alas-

3. The 470 mile (750 kilometer) Alaska Railroad extends from the city of Fairbanks, heading southward, through the city of Anchorage, to Seward on Alaska's southern coast—ed.

ka and Siberia, the longest continuous length of tunnel under water would be about 22 miles, just a little less than the continuous underwater distance of the Channel tunnel between France and England. The Bering Strait is a shallow body of water no deeper than the English Channel, so the tunnel need not be at any significantly greater depth than the English Channel tunnel. In fact the tunnel would be much less deep than the existing railway tunnel connecting the main Japanese island of Honshu with the island of Hokkaido.

...The rock beneath the Bering Strait is sound and the tunnel would involve no unprecedented difficulties in this regard.

From an engineering standpoint and from a standpoint of economics it is obvious that this is not a project that is going to be started tomorrow, but could easily be part of a future world economy in a time frame from ten to twenty years. In discussing this tunnel project, its feasibility assumes an expanding level of world commerce and prosperity, and it also assumes the continued lessening of the international tensions that have restricted trade and economic developments in the past.

This plan does fit in with the growing trend to interconnect the rail networks of the world. The new line connecting China and the Commonwealth of Independent States in Khasakstan has recently been completed, and of course we are all familiar with the impending connection of the British and European continental railway networks through the Channel tunnel. In the last decade, for the first time, all four main islands of Japan have been connected by rail. A tunnel under the Straits of Gibraltar to connect the the rail network of Europe and North Africa is being proposed. A plan has recently been proposed by the Official Economic Planning Agency in Central America to connect the railways of Central America to form a continuous standard gauge from Mexico to Panama. But the Bering Strait tunnel project is the key link, connecting the western hemisphere with the eastern hemisphere. In this new era of peace between Russia and the United States, perhaps even a name such as the World Peace Tunnel is not too grandiose, since it would link by land transport all the continents of the world except Australia and Antarctica.

The AREA [American Railway Engineering Association] is forming a technical committee to work on the engineering aspects of this project.

...[T]he AREA encourages the detailed study of a railway from North America to Asia via a tunnel under the Bering Strait. In addition to the advantages of joining the United States and Russia with a railway, one of the main economic justifications for this project is the present and future Pacific Rim traffic, which railroads could handle in one seamless trip without changing modes of transportation from the Orient to North America via a route shorter than that presently used and at speeds higher than presently run.

# Bush Nuclear Program: Technology Apartheid

by Marjorie Mazel Hecht

The Bush Administration's Global Nuclear Energy Partnership, or GNEP, is a program of technological apartheid dressed up as nuclear development. It is the civilian side of the British geopolitical strategy, first enunciated by Bertrand Russell and H.G. Wells in the first half of the 20th Century, to consolidate power in a single or small group of states, and deny technological development to most of the world. Like the global warming hoax, behind it lies a Malthusian program for checking population growth, especially of non-white populations.

Under GNEP, the United States would provide selected nations with all aspects of the nuclear fuel cycle—in a “black box.” The recipient countries must agree not to develop those technologies on their own, thus denying those nations knowledge of uranium enrichment, fuel fabrication, and reprocessing, as well as nuclear applications like desalination or medical isotopes. The program aims to control the nuclear fuel cycle “from cradle to grave,” as U.S. Energy Secretary Samuel Bodman said. Recipient nations will have only a leased black box—as long as they stay on the good side of the supplier.

GNEP is thus an attack on the national sovereignty of recipient nations, which must give up control over their energy resources and over the training of nuclear scientists and engineers.

From the beginning of the civilian nuclear age, just after World War II, there were two views of the nuclear future. One faction saw nuclear energy as a boon for all mankind, providing virtually unlimited energy to develop industry and raise living standards. The other were the proponents of the Bertrand Russell/H.G. Wells policy, who aimed to prevent Third World development and population growth, by keeping the nuclear genie bottled up. Their program was conveyed in the 1946 Baruch Plan, an earlier version of GNEP, which intended to put a United Nations agency in control of all nuclear fuel. The policy was carried forward from the 1950s by a school of truly mad strategic analysts centered for a time in the Rand Corporation. The leading figure was Albert Wohlstetter, the real model for Stanley Kubrick's fictional “Dr. Strangelove,” whose students included the prominent neocon strategists, Richard Perle and Paul Wolfowitz.

## Selling Points vs. Reality

GNEP was sold to the U.S. nuclear community on the basis that it will fund research and construction of three new fa-

cilities: 1) a nuclear reprocessing facility using new methods that will make it harder to divert nuclear fuel for bomb making; 2) a nuclear fast reactor, which would be geared not to breed new fuel, but instead just to burn up the long-lived radioisotopes (actinides) in spent fuel; and 3) an advanced fuel cycle research facility, to look into new methods of reprocessing and new fuel cycles.

Eleven sponsors for potential sites for the first two facilities have been selected to receive grants to prepare “detailed siting studies.” One is the Hanford Site in Washington State, where, in 2005, the Bush Administration shut down the Fast Flux Test Facility, a working research fast reactor that was perfectly suited to perform the R&D proposed by GNEP, and to burn up actinides.

There is no question that the United States needs an advanced nuclear program, which will include recycling, enrichment, fuel cycle research, and development of the fast reactor and other advanced reactors. But GNEP is a go-slow program, which may (or may not) produce a new reactor or new technologies in the next 10-15 years. It is not a crash development program to build the research facilities and the advanced reactors the nation—and the world—need. GNEP’s focus is nonproliferation enforcement, at home and abroad.

The Department of Energy’s funding for GNEP is up to \$60 million in the next two years, for conceptual studies, scheduling, and design. It has managed to hook in the nuclear community, as well as all the national laboratories, because it is the *only* Federal nuclear program going. As for the foreign countries participating, most of them—Russia, China, and Japan, for example—already reprocess their spent fuel, and have ambitious programs for research and construction, including fast breeder reactors. They have nothing to lose by participating in GNEP—unless they get so tangled in the web of bureaucracy that they stop forging ahead with their own programs.

## U.S. No Longer a Nuclear Leader

Although the United States now has nearly one-fourth of all the world’s nuclear reactors (104 out of 435), more than any other country, it has taken a back seat to other nuclear nations in the development of nuclear technology. The U.S. shut down its commercial reprocessing (recycling) capability in the 1970s, although its PUREX reprocessing facility was working well. Since then, the U.S. has had a once-through nuclear fuel cycle, instead of recovering the 97% of the spent nuclear fuel that could be turned into new fuel.<sup>1</sup> The reason for the shutdown was ostensibly to prevent “proliferation,” because reprocessing spent fuel separates out plutonium (about 1% of the spent fuel), which

1. See “The Beauty of the Nuclear Fuel Cycle,” [www.21stcenturysciencetech.com/2006\\_articles/NuclearFuel.W05.pdf](http://www.21stcenturysciencetech.com/2006_articles/NuclearFuel.W05.pdf)

might be stolen and used for bomb-making.

The real reason is that by allowing reprocessing, nuclear energy becomes fully “renewable” and therefore fully able to supply increasing amounts of energy for a growing world. This is what the Russellites wanted to prevent, using the banner of nonproliferation to do it. Meanwhile, spent fuel rods—containing a valuable resource—are sitting in storage.<sup>2</sup>

In addition to the shutdown of reprocessing, there was a virtual shutdown of enrichment technology. Enrichment involves increasing the ratio of fissionable uranium (U-235) to unfissionable uranium (U-238) from the 0.7% found in natural uranium to 3-4% required for fission reactors. The U.S., which had pioneered uranium enrichment methods for nuclear fuel, now must import more than 80% of the enriched uranium for its 104 nuclear plants. The nation also shut down its fast breeder program, although fast reactors are essential to the future of nuclear.

GNEP has captured the allegiance not only of the nuclear community, but of the national laboratories, which historically have been leaders of U.S. nuclear research, both civilian and military. When this writer posed the question of GNEP and its coercive nonproliferation function to Dr. Robert Rosner, the director of the Argonne National Laboratory, he replied “I’ll give you the reason why it’s a good thing. It’s not so much proliferation, it’s economic.” In Rosner’s view, countries that want to develop nuclear power plants will choose the GNEP way because it’s cheaper. As for the political control, Rosner said that countries could choose a supplier from among the seven or so advanced nuclear nations—including Russia and China.

As for proliferation, Rosner said: “The key point here is that what GNEP does, if you really put this regime in place—then if someone refuses to be part of it, it’s perfectly clear why. It could only be one reason. So at least there’s this wonderful element of clarity. With GNEP, if you don’t participate, then you basically are interested in proliferation.”

And so, we do have clarity: GNEP is about policing nonproliferation, removing national sovereignty, and ensuring technological apartheid, not about advancing nuclear technologies for the benefit of mankind. Much of the U.S. nuclear community has bought into it, along with the fraud of global warming, thus crippling their capability to fight for the kind of nuclear development program that will build the 6,000 nuclear power plants the world needs by the year 2050.<sup>3</sup> Instead of siding with Prometheus, the giver of fire (the atom) to mankind, these supporters of GNEP are working with Zeus to keep Prometheus bound.

2. The spent fuel from one 1,000 mw nuclear plant, operated over 40 years, is roughly equivalent to 130 million barrels of oil, or 37 million tons of coal.

3. See “How To Build 6,000 Nuclear Plants by 2050,” by James Muckeheid, State Nuclear Engineer of Massachusetts, [www.21stcenturysciencetech.com/Articles%202005/6000NuclearPlants.pdf](http://www.21stcenturysciencetech.com/Articles%202005/6000NuclearPlants.pdf)

## Blackstone Goes Public

*The giant private equity firm's public offering is the equivalent of a canary in the mine.*

Coal miners used to take canaries down into the mines as an early warning system; if the canary died, it was time for the miners to evacuate. Blackstone, the giant private equity group, undoubtedly would prefer a more testosterone-soaked metaphor, but in selling shares to the public, the firm is acting like the proverbial canary, signaling that changes are afoot.

Blackstone Group, founded in 1985 by Peter G. Peterson and Stephen Schwarzman, has some \$88 billion in funds under management, and owns all or parts of companies which employ some 375,000 people. While predominately a private equity fund which uses its clients' money and borrowed funds to buy companies, Blackstone is also a major player in the real estate market and a hedge fund operator. The company went public, raising \$4 billion in cash; its stock began trading on the New York Stock Exchange on June 22.

One of the mantras of the private equity and hedge fund sector in recent years has been that because they are private partnerships, they can respond more quickly and aggressively to market situations than can companies which have to answer to shareholders, and thus make money more effectively. However, if being private is the key to their success, why are they now going public? Wouldn't having shareholders make them less efficient, by their own claims?

This, of course, is where the story starts to get interesting. The IPOs by Fortress Investment and Blackstone, and the rumors that others such as KKR are considering the same, are

signs that they know the game is over, and are hoping to cash out before it all blows up. By going public, they are spreading the risk among a larger number of stockholders—right before the blowout they anticipate.

Joseph Rice III, the chairman of buyout firm Clayton, Dubilier & Rice, made the same point when he told Bloomberg recently that private equity activity appeared to be "pretty close to the peak." Rice characterized the recent record levels of private equity deals as being at a "cyclical high," adding that "some event may cause us to tip over."

Another, far more significant signal came from the Bank for International Settlements (BIS), the Swiss-based institution which functions as a central bank of sorts for the global central banking system. In its annual report issued June 24, the BIS suggested that the "current rapid expansion" of monetary and credit growth will have to be ended to keep inflation under control.

Blackstone is an insider in this game. Peterson and Schwarzman were formerly with Lehman Brothers, and Peterson has an even longer connection to Lazard. Peterson was tapped by George Shultz to join the Nixon Administration in 1971, to head the team writing the justification for taking the dollar off the gold reserve standard, and was rewarded with a stint as Secretary of Commerce, after which he joined Lehman Brothers as deputy chairman and then, chairman. During his tour in Washington, his blind trust was managed by Lazard's Felix Rohatyn, who is now at Lehman himself.

Blackstone is an outgrowth of

those connections. Its new board of directors includes Lord Jacob Rothschild, and its international advisory board includes David Verey, the former chairman of Lazard Brothers in London; Ivan Pictet of Pictet & Cie., one of the largest private banks in Switzerland; and Jacob Wallenberg, chairman of Skandinaviskia Enskilda Banken and head of the Wallenberg family investment firm. It also includes Niall FitzGerald, a Knight Commander of the British Empire who is a former chairman of the Anglo-Dutch Unilever and current head of Reuters; and Maurice Levy of the advertising giant Publicis, whose board includes Rohatyn, former Lazard chairman Michel David-Weill, and Rothschild et Cie.'s Gerard Worms.

The fantasy of the Anglo-Dutch imperial financiers is that they can gradually take down the bubble as they reorganize the world politically around their markets and their imperial cartels. Such a takedown would be brutal and bloody, the equivalent of cutting off heads to fit a declining number of hats. The financiers believe that they have virtualized the system to the point that they can control its disintegration, lopping limbs off here and there, and hiding much of the damage in the hedge fund/derivatives casino.

They are wrong, and their faith in mathematical formulae and market manipulation is misplaced. Their system cannot be fixed from within, as the solution to the crisis lies outside the realm of finance. The real problem is the way the productive sector of the U.S. economy has been systematically dismantled and replaced with financial speculation and paper-pushing.

Solving this problem requires using the power and credit of sovereign governments to rebuild our productive base. Physical economy, not finance, is the answer.



# *Independence Day 2007*

In the course of an interview with Ecuadorean radio on June 29, Democratic leader and American statesman Lyndon LaRouche expressed his optimism about the current international offensive against London-based imperial power, and especially its leading tool, Vice President Dick Cheney. LaRouche said:

“I would say, that as of July 4th, which is the U.S. Independence Day celebration, from that time on, there will be a massive drive for the sudden resignation of Dick Cheney from his position. It may not work, but I think it will. And some very powerful forces are agreed to do that. Which makes me rather happy, but not satisfied.”

Why not satisfied? LaRouche was asked. He replied:

“It would open a door—then you have to go into the room beyond the open door. . . .

“The fight is to get back to the system of sovereign nation-states, not globalization, and return power to the sovereign governments of the people. And to use that, as a basis for creating new forms of international cooperation among sovereign nations. And that fight has to be waged. But getting rid of Cheney will open the door in that direction.”

LaRouche’s statement should serve, once again, as a spur to American patriots, to redouble their efforts to assert the principles of 1776, including the sovereign commitment of the nation to procuring the right to “life, liberty, and the pursuit of Happiness” to all of our citizens, as well as humanity as a whole. Despite all the flag-waving, the depth of the republican commitment of America’s intellectual fathers, has been lost in recent decades. And along with that loss has come the acceptance of a surrender of economic and political sovereignty as well.

There has always been a tension in American history, of course, between the republicans, and the Tories. On the republican side, we’ve seen George Washington, John Quincy Adams, Abraham Lincoln, and Franklin Delano Roosevelt as the chief champions of raising up the population through government promotion of industry, education, and science, and of building alli-

ances with other nations on the basis of joint commitments to economic cooperation. On the Tory side, we’ve seen a concentration on, or toleration of, the use of force, both economically and politically, with the result of the impoverishment and disenfranchisement of large sections of the population, and a tendency toward foreign, or civil, wars. Andrew Jackson, James Buchanan, Teddy Roosevelt, and Woodrow Wilson most aptly fit this description—prior to the current Cheney Administration.

What has been clear to LaRouche, for some time, is that the true republican legacy of the United States of America has not died. Although ground down by decades of increasing poverty, decorticated education, and outright terrorism, such as 9/11, the American population still maintains an organic commitment to the republic’s founding principles, including those of the most recent great and powerful representative of those principles in the White House, President Franklin D. Roosevelt.

How to bring that commitment forward? That has been a long battle of consistent advocacy for republican principles, in holding up the standard even when others have trembled in fear, and essentially hidden under the bed. We in the LaRouche movement, led by LaRouche himself, have waged that fight through often difficult conditions, in the conviction that all of humanity’s victories have been made possible only by a small handful of leaders who refused to give up the cause of civilization under the most oppressive of circumstances.

An essential ingredient has been added with LaRouche’s founding of a youth movement of unsurpassed intellectual and moral qualities, which inspires the older generation to redouble its effort to secure the future.

Thus, we approach this July 4, 2007 with a new sense of hope. The recent turn against the British-Cheney Tories has set the stage, and the troops have begun to move forward on the field. The potential for victory is in sight. Let us remember our ancestors, and not falter.